

CATALOGUE GÉNÉRAL CATÁLOGO GENERAL MAIN CATALOGUE

Mobilier
Mobiliario
Furniture





ENTERPRISE EMPRESA BUSINESS

MOBEL LINEA, S.L. est une entreprise familiale fondée en 1973 et située à Cervera (Lleida), Espagne.

Depuis le début, comme fabricants de mobilier de bureau, notre objectif a été de proposer des solutions simples, fonctionnelles, innovantes et de qualité pour transformer les espaces de travail en écosystèmes de productivité, de coexistence et de confort. La motivation constante à nous rapprocher des gens a eu un impact positif sur notre façon de travailler et de nous organiser en appliquant de nouvelles méthodologies et processus.

Au fil des années, nous avons acquis une notoriété dans le secteur et nous nous sommes imposés comme l'un des principaux fabricants de mobilier de bureau au niveau national et européen.

Malgré l'équipe de 280 personnes, nous continuons à garder vivante notre essence familiale.

MOBEL LÍNEA, S.L. somos una empresa familiar fundada en el año 1973 y situada en Cervera, provincia de Lérida (España).

Somos fabricantes de mobiliario de oficina, y desde los inicios, nuestro propósito ha sido ofrecer soluciones sencillas, funcionales, innovadoras y de calidad para transformar los espacios de trabajo en ecosistemas de productividad, convivencia y confort. Nuestra motivación constante por acercarnos a las personas ha impactado de forma positiva en nuestra forma de trabajar y de organizarnos aplicando nuevas metodologías y procesos.

Con el paso de los años hemos ido ganando notoriedad en el sector y nos hemos consolidado como uno de los fabricantes de muebles de oficina líder a nivel nacional y Europeo.

A pesar de contar con un total de 280 trabajadores, seguimos manteniendo viva nuestra esencia familiar.

MOBEL LINEA, S.L. is a family run business founded in 1973 and located in Cervera (Lleida), Spain.

As manufacturer of office furniture and seating, from the beginning, the aim has been to offer functional, innovative, and quality solutions to transform offices into spaces of productivity, collaboration, and well-being. The focus on people has a positive impact on the way Mobel Linea sees the future of working and organizing by applying new methodologies and processes.

Over the years the company has grown into an important player in the office furniture industry in Western Europe.

With a total of over 280 workers, Mobel Linea still maintains the family essence alive.



RESSOURCES RECURSOS RESOURCES

Nos instalaciones, como l'équipe humaine de notre usine, se sont développées progressivement, en s'adaptant aux demandes et besoins du marché. En 1995, la production de l'usine a été divisée en deux entrepôts, l'un pour bois et l'autre pour le métal:

- MOBEL I: Entrepôt principal, d'une surface de 45.000 m², destiné à la fabrication de mobilier et sièges.
- MOBEL III: situé dans la zone industrielle et d'une surface de 13.000 m², il est destiné à la fabrication de composants, structures et armoires métalliques.

Notre production est gérée par une unité logistique novatrice depuis la création d'un entrepôt en 2004 entièrement automatisé et auto-portant avec une capacité de 33.000 europallettes. D'une hauteur de 41 mètres ce entrepôt est un point de référence sur le territoire.

Déjà en 2011, création d'une annexe de l'autre usine située dans la zone industrielle pour la fabrication des armoires métalliques. À cette époque, nous avons profité de l'intervention pour remplacer le tunnel de peinture par un tunnel beaucoup plus performant et écoresponsable.

Actuellement, nous nous engageons à accroître notre capacité de production en investissant dans une nouvelle ligne de fabrication de 2.000 m² avec laquelle nous atteindrons une plus grande capacité de production, une meilleure automatisation, une meilleure qualité de nos produits ainsi qu'une considérable réduction de la consommation énergétique.

Nuestras instalaciones, al igual que el equipo humano, han ido creciendo de forma progresiva adaptándose a las demandas del mercado. En 1995 se dividió la producción de la fábrica en dos naves, una para la madera y otra para el metal:

- MOBEL I: Nave principal, con una superficie de 45.000 m², destinada a la producción de mobiliario de madera y sillería.
- MOBEL III: ubicada en el polígono industrial y con una superficie de 13.000 m² está destinada a la fabricación de estructuras y muebles metálicos.

En 2004 construimos un almacén automatizado que supuso la trazabilidad absoluta de la producción de la fábrica. El almacén destaca por su dimensiones, 41 metros de altura y una capacidad de hasta 33.000 europalets, y lo convierte en un punto de referencia en el territorio.

Ya en 2011, ampliamos la nave situada en el polígono industrial con el fin de fabricar armarios metálicos. En ese momento, aprovechamos la intervención para sustituir el túnel de pintura por otro mucho más eficiente y responsable con el Medio Ambiente.

En la actualidad, apostamos por ampliar nuestra capacidad productiva invirtiendo en un nuevo tren de producción de 2.000 m² con el que lograremos: mayor capacidad de producción, mayor automatización entre procesos, mayor calidad en nuestros productos y menor consumo energético.

Mobel Linea has been growing progressively, adapting to market demands. In 1995 the factory opened a second facility for metal production, so nowadays Mobel Linea's production takes place in:

- MOBEL I: Main facilities, with an area of 45,000 m², headquarters and where production of wooden furniture and chairs finds place.
- MOBEL III: located in the nearby industrial estate, with 13,000 m², is the place for the manufacture of metal cabinets, frames, and other metal parts.

In 2004 an all-automated warehouse was built for raw materials, stocks, and finished products. The warehouse stands out for its big dimensions, is 41 meters high and has a capacity of up to 33,000 Euro pallets, making it a point of reference in the landscape of Cervera.

In 2011, MOBEL III expanded to produce metal cabinets and the installation of a brand-new painting tunnel meeting the latest requirements in terms of efficiency and the environment.

This year, we invested in a new 2,000 m² production plant with which we are achieving: higher production capacity, better automation between processes, lower energy consumption and improving product quality.

CROISSANCE CONSTANTE

CRECIENDO DE FORMA
CONSTANTE

STEADY GROWTH



QUALITÉ CALIDAD QUALITY

La satisfaction client est inscrite dans notre ADN, c'est pourquoi nous veillons jour après jour à la qualité de tous nos produits.

Depuis 2001, nous sommes certifiés conformément aux normes de gestion de la qualité établies dans la norme **ISO 9001**. Essentiellement, avec cette norme, nous garantissons que tous les processus visent l'efficacité du système de gestion et l'assurance qualité de nos produits et services. De plus, le lien implicite entre **ISO 9001**, **ISO 14001**, **ISO 14006** et PEFC nous permet de réaliser un système de management intégré axé sur le management environnemental.

Nos produits sont de haute qualité et ils bénéficient du tampon qualité contrôlée après avoir été soumis à des tests rigoureux de sécurité et de durabilité par le laboratoire de l'institut technologique du meuble, bois, emballages et autres, **AIDIMME**.

La satisfacción de los clientes está inscrita en nuestro ADN, por eso velamos día tras día por la calidad de todos nuestros productos.

Desde el año 2001 estamos certificados de acuerdo con los estándares de gestión de calidad establecidos en la norma **ISO 9001**. En esencia, con esta norma, garantizamos que todos los procesos están orientados a la eficacia del sistema de gestión y al aseguramiento de la calidad de nuestros productos y servicios. Adicionalmente, la vinculación implícita entre la **ISO 9001**, la **ISO 14001**, la **ISO 14006** y el PEFC nos permite llevar a cabo un sistema de gestión integrado incidiendo en la gestión ambiental.

Fabricamos productos de alta calidad y por eso nuestros muebles llevan el sello de calidad tras ser sometidos a rigurosas pruebas de seguridad y durabilidad en el laboratorio **AIDIMME**, Instituto Tecnológico Metalmeccánico, Mueble, Madera, Embalaje y Afines.

Customer satisfaction is very important for Mobel Linea, which is why the quality of all the products are ensured day after day.

Since 2001 Mobel Linea has been certified in accordance with the quality management standards established in the **ISO 9001** standard. In essence, with this standard, it guarantees that all processes are aimed at the effectiveness of the management system and the quality assurance of their products and services. Additionally, the implicit link between **ISO 9001**, **ISO 14001**, **ISO 14006** and PEFC allows to carry out an integrated management system focusing on environmental management.

Manufacturing high-quality products and is why the furniture bears the seal of quality after being subjected to rigorous safety and durability tests in the **AIDIMME** laboratory, Technological Institute for Metalworking, Furniture, Wood, Packaging and Related.

RÉSEAU COMMERCIAL RED COMERCIAL COMMERCIAL NETWORK

Grâce à notre réseau commercial de revendeurs, MOBEL LINEA, S.L. est présente dans différents pays du monde. Nos principaux marchés sont concentrés principalement en Europe (France, Allemagne, Royaume-Uni, la Suisse, la Belgique, la Hollande, Bulgarie, Portugal, Grèce, etc.), mais nous avons également des points stratégiques hors d'Europe (Émirats Arabes, Arabie Saoudite, Qatar, Costa Rica, etc.).

Grâce à notre flotte de 35 camions et 18 remorques, nous sommes en mesure de réaliser des livraisons à tous nos clients européens, garantissant ainsi les délais de livraison demandés et permettant même de les réduire en cas d'extrême priorité.

En plus de nos camions, nous utilisons le transport maritime pour le commerce international par le biais de containers ou groupages, travaillant avec les principales entreprises d'affrètement et obtenant un maximum de garantie de fiabilité, qualité et sécurité de la bonne arrivée de nos produits à destination.

Gracias a nuestra red comercial de representantes y distribuidores, MOBEL LINEA, S.L. está presente en distintos países del mundo. Nuestro nicho de mercado se concentra, en su mayoría, en Europa (Francia, Alemania, Reino Unido, Suiza, Bélgica, Bulgaria, Portugal, Grecia, etc.), pero también tenemos puntos estratégicos fuera de Europa (Emiratos Árabes, Arabia Saudí, Qatar, Costa Rica, etc.).

Disponemos de una flota de 35 camiones y 18 remolques, con los que garantizamos las entregas a todos nuestros clientes europeos, cumpliendo con los plazos de entrega exigidos e incluso reduciéndose en casos de extrema prioridad.

Además de nuestros camiones, para el Comercio Internacional, utilizamos el transporte marítimo, con contenedores o grupajes, trabajando con las principales compañías navieras del mercado y obteniendo las máximas garantías de fiabilidad, calidad y seguridad en la llegada de nuestros productos a destino.

Thanks to a network of representatives and distributors, MOBEL LINEA, S.L. is present in numerous countries around the world. The main market is in Western Europe (France, Portugal, Belgium, The Netherlands, United Kingdom, Germany and Switzerland), but also sells in Eastern Europe, the Middle East, South America and several African Countries.

Mobel Linea has its own fleet of 35 trucks to deliver European customers, being able to guarantee fast deliveries and reduce product-damage due to transport.

For overseas deliveries Mobel Linea works with well-known shipping companies to obtain the maximum guarantees of reliability, quality and safety in the transport of the products.



GARANTIE DE QUALITÉ
ET SATISFACTION

ASEGURAMOS CALIDAD Y
SATISFACCIÓN

QUALITY AND SATISFACTION
GUARANTEE

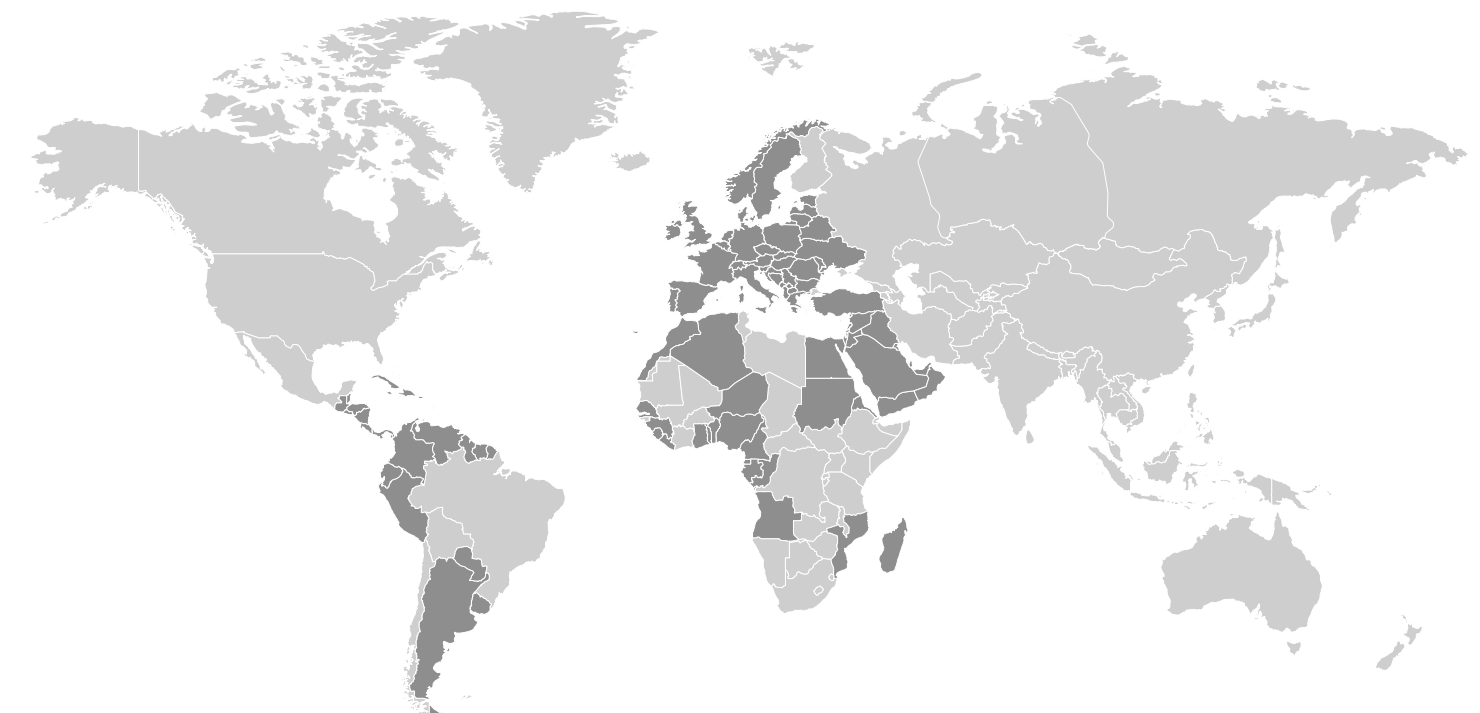

Zones d'implantations MOBEL LINEA.
Zonas donde actualmente está presente MOBEL LINEA, S.L.
States with MOBEL LINEA, S.L. Partners.

INVESTISSEMENT ET DÉVELOPPEMENT

INVESTIGACIÓN Y DESARROLLO

RESEARCH AND DEVELOPMENT

En tant que concepteurs-designers et fabricants de mobilier de bureau, nous répondons aux besoins du marché en apportant valeur et professionnalisme. Nous créons des produits axés sur les besoins des gens. Nous analysons leur comportement en tenant compte de l'évolution technologique et des méthodologies de travail afin de le transformer en bureau.

Dans le processus de conception et de développement, nous sommes soutenus et guidés par les prémisses de l'**Écodesign**, réduisant l'impact environnemental de nos produits tout au long de leur cycle de vie en appliquant différentes stratégies:

- Utilisation de matériaux recyclables.
- Bois issu de sources durables: certification **PEFC**.
- Réduire l'impact environnemental du transport et des déchets d'emballage générés.
- Garantir le moindre impact environnemental lors de l'utilisation.
- Tenir compte du tri et de la haute recyclabilité des composants en fin de vie.

Notre proposition de valeur se concentre sur l'intemporalité du design, offrant fonctionnalité, confort et durabilité à nos clients. Le temps et la confiance nous motivent à avancer et à continuer à apporter de l'expérience et de l'innovation.

Como diseñadores y fabricantes de mobiliario de oficina atendemos a las necesidades del mercado aportando valor y profesionalidad. Creamos productos poniendo el foco en las necesidades de las personas. Analizamos sus comportamientos fijándonos en la evolución tecnológica y las metodologías de trabajo para detectar oportunidades y transformar su experiencia en la oficina.

En el proceso de concepción y desarrollo nos apoyamos y guiamos por las premisas del **Ecodiseño**, reduciendo el impacto ambiental de nuestros productos a lo largo de su ciclo de vida aplicando diferentes estrategias:

- Uso de materiales reciclables.
- Madera procedente de fuentes sostenibles: certificación **PEFC**.
- Reducir el impacto ambiental del transporte y de los residuos generados de embalajes.
- Asegurar el menor impacto ambiental durante el uso.
- Tener en cuenta la separación y la alta reciclabilidad de los componentes al final de su vida útil.

Nuestra propuesta de valor se centra en la atemporalidad del diseño aportando funcionalidad, comodidad y durabilidad a nuestros clientes. El tiempo y la confianza han estimulado nuestras ganas y nuestra motivación para seguir escalando peldaños en el mercado brindando experiencia e innovación.

As designers and manufacturers of office furniture, the needs of the market are served, providing value and professionalism, and always focusing on the needs of people. Analysing their behaviour by looking at technological evolution and work methodologies to detect opportunities and so transform the people's experience in the office.

In the process of conception and development, supporting and guiding by the premises of **Eco-design**, reducing the environmental impact of all the products throughout their life cycle by applying different strategies:

- Use of recyclable materials.
- Wood from sustainable sources: **PEFC** certification.
- Reduce the environmental impact of transport and packaging waste generated.
- Ensure the least environmental impact during use.
- Consider the separation and high recyclability of the components at the end of their useful life.

Mobel Linea's value proposition focus on the timelessness of design, providing functionality, comfort, and durability to the customers. Time and trust have stimulated Mobel Linea's desire and motivation to continue climbing steps in the market, providing experience and innovation.

| ÉCOCONCEPTION

| ECODISEÑO

| ECODESIGN

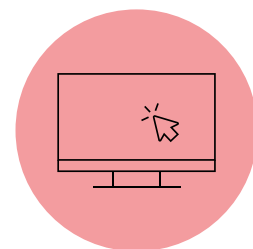

RECHERCHE
INVESTIGACIÓN
RESEARCH



DÉVELOPPEMENT
DESARROLLO
DEVELOPMENT

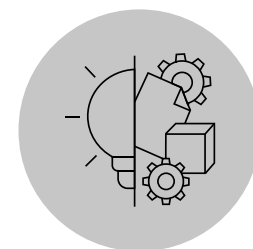

INNOVATION
INNOVACIÓN
INNOVATION



ENVIRONNEMENT MEDIO AMBIENTE ENVIRONMENT

Notre engagement envers l'environnement est rigoureux et transparent. Chez Mobel Linea nous appliquons un système de gestion durable aux produits et aux installations qui est essentiel pour réduire l'impact environnemental. La durabilité et l'environnement représentent une responsabilité pour chacun.

En 2005, nous avons intégré la norme **ISO 14001** en Systèmes de Gestion Environnementale qui nous certifie en tant qu'entreprise respectueuse de l'environnement et garantit un travail actif dans l'amélioration continue de nos processus de fabrication.

Notre principale matière première est l'aggloméré de particules en bois avec un traitement spécial superficiel de résines mélaminiques. La certification **PEFC** atteste de notre engagement avec l'Environnement.

La gestion durable commence dès la conception du produit. Pour cette raison, depuis 2013, chez MOBEL LINEA nous avons mis en place la norme **ISO 14006** qui permet d'intégrer un Système de Gestion Environnementale d'**Ecodesign**. Ainsi, lorsque nous concevons un nouveau produit, nous considérons l'impact environnemental qu'il peut avoir dans toutes les phases de son cycle de vie et nous essayons de le réduire sans altérer la qualité de ce produit.

Nuestro compromiso con el medio ambiente es riguroso y transparente. En Mobel Linea aplicamos un sistema de gestión sostenible a los productos e instalaciones que es esencial para reducir el impacto ambiental. La sostenibilidad y el medio ambiente representan una responsabilidad para todos.

En 2005 integramos la normativa **ISO 14001** en Sistemas de Gestión Ambiental que nos certifica como empresa respetuosa con el medio ambiente y garantiza el trabajo activo en mejora continua de nuestros procesos de fabricación.

Una de nuestras materias primas es el aglomerado de partículas de madera con un tratamiento superficial de resinas melamínicas. La certificación **PEFC** que recibe el producto certifica nuestro compromiso con el Medio Ambiente.

La gestión sostenible empieza en el diseño. Por eso, desde el año 2013, en Mobel Linea implementamos la norma **ISO 14006** que permite implantar un sistema de gestión ambiental de **Ecodiseño**. Así pues, cuando proyectamos un nuevo producto contemplamos el impacto ambiental que puede tener en todas las fases de su ciclo de vida y tratamos de reducirlo sin afectar la calidad de dicho producto.

Commitment to the environment is rigorous and transparent. Mobel Linea applies a sustainable management system that is essential to reduce the environmental impact. Sustainability and the environment represent a responsibility for everyone.

Since 2005 the **ISO 14001** standard certifies Mobel Linea as a company that respects the environment and guarantees active work in continuous improvement of its manufacturing processes.

One of the raw materials is the agglomerate of wood particles with a surface treatment of melamine resins. The **PEFC** certification of this raw material certifies the commitment to the Environment.

Sustainable management begins in the design. For this reason, since 2013, Mobel Linea implements the **ISO 14006** standard that allows an **Eco-design** environmental management system. Thus, when a new product is designed, the environmental impact that it may have in all phases of its life cycle is considered and reduced without affecting the quality of the product.

| DURABILITÉ
| SOSTENIBILIDAD
| SUSTAINABILITY



Matériaux recyclables.
Materiales reciclables.
Recyclable materials.



Optimisation des emballages.
Optimización de embalaje.
Packaging optimization.



Bois issu de sources durables.
Madera de fuentes sostenibles.
Wood from sustainable sources.



Recyclabilité en fin de vie utile.
Reciclabilidad al final de vida útil.
Recyclability at the end of its useful life.



PEFC
PEFC/14-35-00142

MOBILIER
MOBILIARIO
FURNITURE

INDEX

RÉGLABLES
REGULABLES
ADJUSTABLE HEIGHT 016

TABLES BASSES
MESAS DE CENTRO
COFFEE TABLES 262

MOBILIER MODULAIRE
INSTALACIONES
DESK SYSTEMS 042

CLOISONS
MAMPARAS
SCREENS 294

OPÉRATIF
OPERATIVAS
INDIVIDUAL DESKS 106

COLLECTIVITÉS
COLECTIVIDADES
MULTI-PURPOSE TABLES 340

DIRECTION
DIRECCIÓN
EXECUTIVE DESK 144

ACCUEIL
RECEPCIÓN
RECEPTION 372

TABLES HAUTES
MESAS ALTAS
HIGH TABLES 166

RANGEMENT
ALMACENAJE
STORAGE 404

TABLES DE RÉUNION
MESAS DE REUNIÓN
MEETING TABLES 208



FINITIONS

Acabados
Finishes

464 | TISSU / TAPIZADOS / UPHOLSTERY

RÉGLABLES
REGULABLES
ADJUSTABLE HEIGHT



018 | UP



030 | TRAM

Up

Cette gamme de bureaux opératifs au design contemporain et futuriste existe en deux versions: fixe ou réglable. La version réglable électriquement permet d'ajuster la hauteur au besoin de l'utilisateur.

Mesa operativa con un diseño moderno y futurista. Hay dos modelos a escoger: la fija o la elevable. La mesa elevable dispone de un sistema eléctrico que permite adaptar la altura de la mesa según las necesidades del usuario.

This office table has a modern and futurist look. There are two options: fixed or height adjustable frame. Each user can choose its favorite table height lifting the desk with an electric engine.

PLATEAU / SOBRE / DESK TOP

Mélamine / Melamina / Melamine: 25 mm
Stratifié / Estratificado / Stratified:
Phénolique / Fenólico / Phenolic: 13 mm

Chant en ABS / Canto ABS / ABS edges

STRUCTURE / ESTRUCTURA / FRAME

Acier:
Acero: 70 x 70 x 2 mm
Steel:



FINITION STRUCTURE / ACABADO ESTRUCTURA / FRAME FINISH

Peinture époxy
Pintura epoxi
Epoxy paint

HAUTEUR / ALTURA / HEIGHT

65 cm < 130 cm

OPTION / OPCIÓN / OPTION

Voile de fond / Faldón / Modesty panel
Goulotte / Bandeja electrificación / Cable tray
Support écran / Soporte pantalla / Monitor holder
Cloisonnettes / Plafones / Screens

ENSEMBLE DE
BUREAUX RÉGLABLES
EN HAUTEUR

CONJUNTO
DE MESAS
ELEVABLES

HEIGHT ADJUSTABLE
FACE TO FACE
DESKS

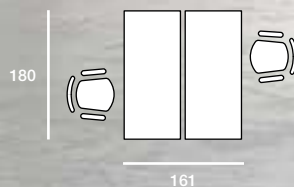

BUREAUX À
HAUTEUR FIXE
AVEC FORME

MESA
FIJA CON
FORMA

FIXED HEIGHT
DESK WITH
SHAPE



BUREAUX À
HAUTEUR FIXE
AVEC CRÉDENCE

MESA FIJA
INDIVIDUAL
CON CREDENCIA

FIXED HEIGHT
DESK WITH
SIDE CREDENZA



Combinable avec caissons et crédences.
Combinable con cajoneras y credencias.
Combine with pedestals and credenzas.

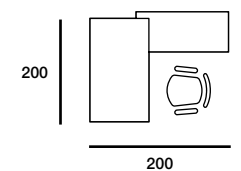

BUREAUX EN VIS
À VIS RÉGLABLES
EN HAUTEUR

MESAS
ENFRENTADAS
ELEVABLES

HEIGHT ADJUSTABLE
FACE TO FACE
DESKS





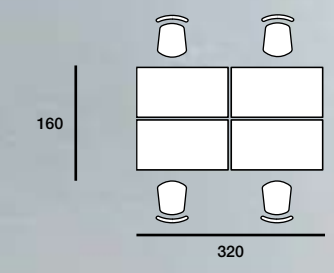



Plateau coulissant sur 14 cm.
El sobre puede deslizarse 14 cm.
Sliding top 14 cm.

















MODÈLES | VARIANTES | VERSIONS

RÉGLABLE EN HAUTEUR / REGULABLE EN ALTURA / ADJUSTABLE HEIGHT

MODÈLE / VARIANTES / VERSIONS	DIMENSIONS / MEDIDAS / MEASUREMENTS	RÉFÉRENCE / REFERENCIA / CODE			
 Bureau individuel Mesa rectangular Rectangular desk	220 x 80 cm 200 x 80 cm 180 x 80 cm 160 x 80 cm 140 x 80 cm	591.100... 591.101... 591.102... 591.103... 591.104...	591.200... 591.201... 591.202... 591.203... 591.204...	591.300... 591.301... 591.302... 591.303... 591.304...	
 Bureau individuel avec forme Mesa con forma Shaped executive table	220 x 102,5 cm 200 x 102,5 cm	591.130... 591.131...	591.230... 591.231...	591.330... 591.331...	
 Bureau 120° Mesa 120° 120° desk	120°	591.110...	591.210...	591.310...	
 Bureaux en vis à vis Mesas enfrentadas Face to face desks	180 x 164 cm 160 x 164 cm 140 x 164 cm	591.120... 591.121... 591.122...	591.220... 591.221... 591.222...	591.320... 591.321... 591.322...	
 Type de boîtier réglage hauteur pour chaque plateau Controlador digital para cada sobre Digital display for each desk top	UP & DOWN	ES DE FR 1.591.058.000	CH 1.591.060.000	US 1.591.059.000	UK 1.591.057.000
 BOÎTIER MÉMOIRE / PROGRAMMABLE / PROGRAMMABLE		1.591.062.000	1.591.064.000	1.591.063.000	1.591.061.000







FINITIONS | ACABADOS | FINISHES

STRUCTURE / ESTRUCTURA / FRAME | PLATEAU / SOBRE / DESKTOP



 Argent Plata Silver RAL 9006	 Blanc Blanco White RAL 9016	 Gris Gris Grey	 Hêtre Haya Beech	 Chêne Moyen Roble Maple
 Blanc Blanco White RAL 9016	 Poirier Peral Pear	 Wengué Wengue Wengue	 Acacia Clair Acacia Clara Light Acacia	 Acacia Foncé Acacia Oscura Dark Acacia
 Graphite Grafito Graphite RAL 7022	 Graphite Grafito Graphite	 Chêne Veiné Castaño Claro Oak	 Chêne Gris Castaño Oscuro Dark Oak	

MODÈLES | VARIANTES | VERSIONS

HAUTEUR FIXE / FIJAS / FIXED HEIGHT















MODÈLE / VARIANTES / VERSIONS	DIMENSIONS / MEDIDAS / MEASUREMENTS	RÉFÉRENCE / REFERENCIA / CODE		
 Bureau individuel Mesa rectangular Rectangular desk	220 x 80 cm 200 x 80 cm 180 x 80 cm 160 x 80 cm 140 x 80 cm	591.140... 591.141... 591.150... 591.151... 591.152...	591.240... 591.241... 591.250... 591.251... 591.252...	591.340... 591.341... 591.350... 591.351... 591.352...
 Bureau rectangulaire pour crédence Mesa rectangular con credencia Executive table with side credenza	200 x 80 cm	591.142... 591.143...	591.242... 591.243...	591.342... 591.343...
 Bureau individuel avec forme Mesa con forma Shaped executive table	220 x 102,5 cm 200 x 102,5 cm	591.160... 591.161...	591.260... 591.261...	591.360... 591.361...
 Bureau avec forme pour crédence Mesa con forma con credencia Shaped executive table with side credenza	200 x 102,5 cm	591.162... 591.163...	591.262... 591.263...	591.362... 591.363...
 Bureau 120° Mesa 120° 120° desk	120°	591.153...	591.253...	591.353...
 Bureaux en vis à vis Mesas enfrentadas Face to face desks	180 x 164 cm 160 x 164 cm 140 x 164 cm	591.154... 591.155... 591.156...	591.254... 591.255... 591.256...	591.354... 591.355... 591.356...

| COMPLÉMENTS | COMPLEMENTOS | COMPLEMENTS



MODÈLE / VARIANTES / VERSIONS	DIMENSIONS / MEDIDAS / MEASUREMENTS		RÉFÉRENCE / REFERENCIA / CODE			
 <p>Retour secrétaire Ala taquígrafa Return</p>	À droite / Derecha / Right	100 x 60 cm 80 x 60 cm	591.170.- - 591.172.- -	591.270.- - 591.272.- -	591.370.- - 591.372.- -	
	À gauche / Izquierda / Left	100 x 60 cm 80 x 60 cm	591.171.- - 591.173.- -	591.271.- - 591.273.- -	591.371.- - 591.373.- -	
 <p>Bureau secrétaire Mesa taquígrafa Shorthand desk</p>		100 x 60 cm	591.174.- -	591.274.- -	591.374.- -	
Monochrome / Monocolor / Single-colour						
 <p>Crédence fixe avec portes coulissantes Credencia con puertas correderas Side credenza with sliding doors</p>		Prof./ Depth, 54,2 cm	1 porte coulissante / 1 puerta corredera / Sliding door			
	À droite / Derecha / Right	L. 200 H. 56,2 cm L. 150 H. 56,2 cm	562.101.- - 562.105.- -			
	À gauche / Izquierda / Left	L. 200 H. 56,2 cm L. 150 H. 56,2 cm	562.102.- - 562.106.- -			
	À droite / Derecha / Right	L. 200 H. 56,2 cm L. 150 H. 56,2 cm	562.103.- - 562.107.- -	2 portes coulissantes / 2 puertas correderas / Sliding doors		
	À gauche / Izquierda / Left	L. 200 H. 56,2 cm L. 150 H. 56,2 cm	562.104.- - 562.108.- -			

| FINITIONS | ACABADOS | FINISHES

STRUCTURE / ESTRUCTURA / FRAME | PLATEAU / SOBRE / DESKTOP

 Argent Plata Silver RAL 9006	 Blanc Blanco White RAL 9016	 Gris Gris Grey RAL 7022	 Hêtre Haya Beech RAL 9006	 Chêne Moyen Roble Maple RAL 9006
 Blanc Blanco White RAL 9016	 Poirier Peral Pear RAL 9006	 Wengué Wengue Wengue RAL 9006	 Acacia Clair Acacia Clara Light Acacia RAL 9006	 Acacia Foncé Acacia Oscura Dark Acacia RAL 9006
 Graphite Grafito Graphite RAL 7022	 Graphite Grafito Graphite RAL 7022	 Chêne Veiné Castaño Claro Oak RAL 9006	 Chêne Grisè Castaño Oscuro Dark Oak RAL 9006	
Monochrome Monocolor Single-colour				

| COMPLÉMENTS | COMPLEMENTOS | COMPLEMENTS

MODÈLE / VARIANTES / VERSIONS	TYPE / TIPO / TYPE	DIMENSIONS / MEDIDAS / MEASUREMENTS	RÉFÉRENCE / REFERENCIA / CODE		
 <p>Voiles de fond Faldones Modesty panels</p>	Mélamine / Melamina / Melamine	220 cm	591.601.051	591.601.053	591.601.007
		200 cm	591.602.051	591.602.053	591.602.007
		180 cm	591.603.051	591.603.053	591.603.007
		160 cm	591.604.051	591.604.053	591.604.007
		140 cm	591.605.051	591.605.053	591.605.007
		120°	591.606.051	591.606.053	591.606.007
	Retour secrétaire / Ala taquígrafa / Return		591.607.051	591.607.053	591.607.007
 <p>Goulotte Bandeja electrificación Cable tray</p>	Métal / Metal / Metal	220 cm	591.651.111	591.651.108	591.651.107
		200 cm	591.652.111	591.652.108	591.652.107
		180 cm	591.653.111	591.653.108	591.653.107
		160 cm	591.654.111	591.654.108	591.654.107
		140 cm	591.655.111	591.655.108	591.655.107
		120°	591.656.111	591.656.108	591.656.107
	Retour secrétaire / Ala taquígrafa / Return		591.657.111	591.657.108	591.657.107
 <p>Support écran Soporte pantalla Monitor holder</p>	Individuel / Individual / Single	220 cm	1.596.003.111	1.596.003.108	1.596.003.107
		200 cm	1.596.004.111	1.596.004.108	1.596.004.107
		180 cm	1.596.005.111	1.596.005.108	1.596.005.107
		160 cm	1.596.006.111	1.596.006.108	1.596.006.107
		140 cm	1.596.007.111	1.596.007.108	1.596.007.107
		120°	1.596.008.111	1.596.008.108	1.596.008.107
	Double / Doble / Double		846.693.111	846.693.108	
			846.694.111	846.694.108	

| FINITIONS | ACABADOS | FINISHES

STRUCTURE / ESTRUCTURA / FRAME



 Argent Plata Silver RAL 9006	 Blanc Blanco White RAL 9016	 Graphite Grafito Graphite RAL 7022
--------------------------------------------------------------------------------------------------------------------------------	-------------------------------------------------------------------------------------------------------------------------------	--------------------------------------------------------------------------------------------------------------------------------------

CLOISONNETTES FRONTALES | PLAFONES | FRONT SCREENS

1 NIVEAU / 1 NIVEL / 1 LEVEL

2 NIVEAUX / 2 NIVELES / 2 LEVELS

MODÈLE / VARIANTES / VERSIONS	L.	RÉFÉRENCE / REFERENCIA / CODE
		   RAL 9006 RAL 9016 RAL 7022
Indiv. / Individ. / Single		
180 cm		386.008.--- 386.108.--- 386.208.---
160 cm		386.009.--- 386.109.--- 386.209.---
140 cm		386.010.--- 386.110.--- 386.210.---
Vis à vis / Enfrentadas / Face to face		
180 cm		596.110.--- 596.210.--- 596.310.---
160 cm		596.111.--- 596.211.--- 596.311.---
140 cm		596.112.--- 596.212.--- 596.312.---
Mélamine Melamina Melamine	120°	386.012.--- 386.112.--- 386.212.---

MODÈLE / VARIANTES / VERSIONS	L.	RÉFÉRENCE / REFERENCIA / CODE
		   RAL 9006 RAL 9016 RAL 7022
Indiv. / Individ. / Single		
180 cm		386.021.--- 386.121.--- 386.221.---
160 cm		386.022.--- 386.122.--- 386.222.---
140 cm		386.023.--- 386.123.--- 386.223.---
Vis à vis / Enfrentadas / Face to face		
180 cm		596.120.--- 596.220.--- 596.320.---
160 cm		596.121.--- 596.221.--- 596.321.---
140 cm		596.122.--- 596.222.--- 596.322.---
Mélamine Melamina Melamine	120°	386.025.--- 386.125.--- 386.225.---

FINITIONS ACABADOS FINISHES

007	Graphite Grafito Graphite	051	Argent Plata Silver
053	Blanc Blanco White	054	Gris Gris Grey
055	Hêtre Haya Beech	061	Chêne Moyen Roble Maple
062	Poirier Peral Pear	116	Wengué Wengue Wengue
103	Acacia Clair Acacia Clara Light Acacia	104	Acacia Foncé Acacia Oscura Dark Acacia
272	Chêne Veiné Castaño Claro Oak	273	Chêne Grisé Castaño Oscuro Dark Oak

FINITIONS ACABADOS FINISHES

204	Graphite Grafito Graphite	088	Argent Plata Silver
081	Blanc Blanco White	197	Gris Gris Grey
198	Hêtre Haya Beech	199	Chêne Moyen Roble Maple
200	Poirier Peral Pear	202	Wengué Wengue Wengue
103	Acacia Clair Acacia Clara Light Acacia	104	Acacia Foncé Acacia Oscura Dark Acacia
209	Chêne Veiné Castaño Claro Oak	235	Chêne Grisé Castaño Oscuro Dark Oak



CLOISONNETTES FRONTALES | PLAFONES | FRONT SCREENS

1 NIVEAU / 1 NIVEL / 1 LEVEL

2 NIVEAUX / 2 NIVELES / 2 LEVELS

MODÈLE / VARIANTES / VERSIONS	L.	RÉFÉRENCE / REFERENCIA / CODE
		   RAL 9006 RAL 9016 RAL 7022
Indiv. / Individ. / Single		
180 cm		386.008.000 386.108.000 386.208.000
160 cm		386.009.000 386.109.000 386.209.000
140 cm		386.010.000 386.110.000 386.210.000
Vis à vis / Enfrentadas / Face to face		
180 cm		596.110.000 596.210.000 596.310.000
160 cm		596.111.000 596.211.000 596.311.000
140 cm		596.112.000 596.212.000 596.312.000
Tissu Tapizado Upholstered	120°	386.012.000 386.112.000 386.212.000

FINITIONS ACABADOS FINISHES

Cf. page 464
Ver pagina 464
See page 464

MODÈLE / VARIANTES / VERSIONS	L.	RÉFÉRENCE / REFERENCIA / CODE
Indiv. / Individ. / Single		
180 cm		386.008.--- 386.108.--- 386.208.---
160 cm		386.009.--- 386.109.--- 386.209.---
140 cm		386.010.--- 386.110.--- 386.210.---
Vis à vis / Enfrentadas / Face to face		
180 cm		596.110.--- 596.210.--- 596.310.---
160 cm		596.111.--- 596.211.--- 596.311.---
140 cm		596.112.--- 596.212.--- 596.312.---
Méthacrylate Metacrilato Methacrylate	120°	386.012.--- 386.112.--- 386.212.---

FINITIONS ACABADOS FINISHES

411	Transparent Transparente Clear	412	Blanc opaque Translúcido Translucent
-----	--------------------------------------	-----	--------------------------------------------

MODÈLE / VARIANTES / VERSIONS	L.	RÉFÉRENCE / REFERENCIA / CODE
		   RAL 9006 RAL 9016 RAL 7022
Indiv. / Individ. / Single		
180 cm		386.021.000 386.121.000 386.221.000
160 cm		386.022.000 386.122.000 386.222.000
140 cm		386.023.000 386.123.000 386.223.000
Vis à vis / Enfrentadas / Face to face		
180 cm		596.120.000 596.220.000 596.320.000
160 cm		596.121.000 596.221.000 596.321.000
140 cm		596.122.000 596.222.000 596.322.000
Tissu Tapizado Upholstered	120°	386.025.000 386.125.000 386.225.000

FINITIONS ACABADOS FINISHES

Cf. page 464
Ver pagina 464
See page 464

MODÈLE / VARIANTES / VERSIONS	L.	RÉFÉRENCE / REFERENCIA / CODE
Indiv. / Individ. / Single		
180 cm		386.021.--- 386.121.--- 386.221.---
160 cm		386.022.--- 386.122.--- 386.222.---
140 cm		386.023.--- 386.123.--- 386.223.---
Vis à vis / Enfrentadas / Face to face		
180 cm		596.120.--- 596.220.--- 596.320.---
160 cm		596.121.--- 596.221.--- 596.321.---
140 cm		596.122.--- 596.222.--- 596.322.---
Avec méthacrylate et tissu Con metacrilato y tapizado With methacrylate and upholstered	120°	386.025.--- 386.125.--- 386.225.---

FINITIONS ACABADOS FINISHES

406	Transparent Transparente Clear	427	Blanc opaque Translúcido Translucent
-----	--------------------------------------	-----	--------------------------------------------

MODÈLE / VARIANTES / VERSIONS	L.	RÉFÉRENCE / REFERENCIA / CODE
Indiv. / Individ. / Single		
180 cm		596.113.838 596.213.838 596.313.838
160 cm		596.114.838 596.214.838 596.314.838
140 cm		596.115.838 596.215.838 596.315.838
Vis à vis / Enfrentadas / Face to face		
180 cm		596.116.838 596.216.838 596.316.838
160 cm		596.117.838 596.217.838 596.317.838
140 cm		596.118.838 596.218.838 596.318.838
Acoustique Acústico Acoustic	120°	596.119.838 596.219.838 596.319.838

FINITIONS ACABADOS FINISHES

Cf. page 464
Ver pagina 464
See page 464

TRAM

Bureau réglable en hauteur qui permet de travailler en position assise ou debout selon les besoins de chaque tâche, favorisant le bien-être des personnes. Un bureau capable de satisfaire à la fois le travail concentré et le travail collaboratif.

Mesa regulable en altura que permite trabajar en una postura sentada o de pie según las necesidades de cada tarea fomentando el bienestar de las personas. Un escritorio capaz de satisfacer tanto el trabajo de concentración como el de colaboración.

Height-adjustable table that allows you to work in a sitting or standing posture according to the needs of each task and thereby avoiding a sedentary lifestyle. The perfect workstation for every kind of desk-job.

PLATEAU / SOBRE / DESK TOP

Mélamine / Melamina / Melamine: 25 mm
Chant en ABS / Canto ABS / ABS edges

STRUCTURE / ESTRUCTURA / FRAME - BASIC

Acier: 70 x 70 x 2 mm
Acero: 70 x 70 x 2 mm
Steel: 70 x 70 x 2 mm

STRUCTURE / ESTRUCTURA / FRAME - PLUS

Acier: 75 x 75 x 2 mm
Acero: 75 x 75 x 2 mm
Steel: 75 x 75 x 2 mm

FINITION STRUCTURE / ACABADO ESTRUCTURA / FRAME FINISH

Peinture époxy
Pintura epoxi
Epoxy paint

HAUTEUR / ALTURA / HEIGHT - BASIC

71,5 cm < 117,5 cm

HAUTEUR / ALTURA / HEIGHT - PLUS

60 cm < 130 cm

OPTION / OPCIÓN / OPTION

Goulotte / Bandeja electrificación / Cable tray
Support écran / Soporte pantalla / Monitor holder
Cloisonnettes / Plafones / Screens

BUREAU TRAM
PLUS - AVEC RETOUR
SÉCRETAIRE

MESA TRAM
PLUS CON ALA

TRAM PLUS
DESK WITH
RETURN

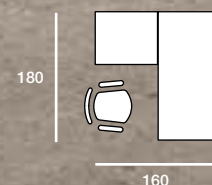

BUREAU TRAM
PLUS - AVEC
BOÎTIER MÉMOIRES

MESA
TRAM PLUS
PROGRAMABLE

TRAM PLUS DESK WITH
4 MEMOIRES DIGITAL
DISPLAY

Boîtier 4 mémoires.
Controlador PROGRAMABLE de cuatro memorias.
4-MEMORIES display.



BUREAUX TRAM PLUS
- EN VIS À VIS AVEC
CLOISONNETTES
FRONTALES

MESAS
TRAM PLUS
ENFRENTADAS
CON PLAFÓN

2 FACE TO FACE
TRAM PLUS DESKS
WITH FRONT
SCREENS

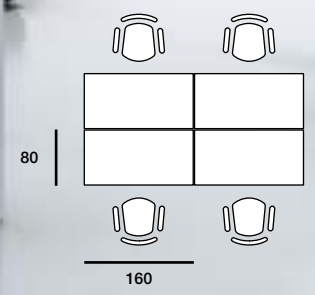



Boîtier UP/DOWN.
Controlador UP/DOWN.
UP & DOWN display.



| BUREAU TRAM BASIC
| AVEC BOÎTIER UP&DOWN

| MESA TRAM BASIC CON
| MECANISMO UP&DOWN

| TRAM BASIC DESK WITH
| UP&DOWN DISPLAY

MODÈLES | VARIANTES | VERSIONS

TRAM BASIC - BOÎTIER UP & DOWN / MECANISMO UP & DOWN / UP & DOWN DISPLAY

MODÈLE / VARIANTES / VERSIONS	DIMENSIONS / MEDIDAS / MEASUREMENTS	RÉFÉRENCE / REFERENCIA / CODE	
	180 x 80 cm 160 x 80 cm 140 x 80 cm 120 x 80 cm	841.102.-- 841.103.-- 841.104.-- 841.105.--	841.202.-- 841.203.-- 841.204.-- 841.205.--

Bureaux individuel
Mesa individual
Individual desk

TRAM PLUS - BOÎTIER 4 MÉMOIRES / CONTROLADOR PROGRAMABLE / 4-MEMORIES DISPLAY

MODÈLE / VARIANTES / VERSIONS	DIMENSIONS / MEDIDAS / MEASUREMENTS	RÉFÉRENCE / REFERENCIA / CODE	
	180 x 80 cm 160 x 80 cm 140 x 80 cm 120 x 80 cm	841.112.-- 841.113.-- 841.114.-- 841.115.--	841.212.-- 841.213.-- 841.214.-- 841.215.--

Bureaux individuel
Mesa individual
Individual desk

	180 x 160 cm 160 x 160 cm 140 x 160 cm 120 x 160 cm	841.122.-- 841.123.-- 841.124.-- 841.125.--	841.222.-- 841.223.-- 841.224.-- 841.225.--
-----------------------------------------------------------------------------------	--------------------------------------------------------------	------------------------------------------------------	------------------------------------------------------













Bureaux avec retour secrétaire
Mesa con ala
Desk with return

	180 x 160 cm 160 x 160 cm 140 x 160 cm 120 x 160 cm	841.142.-- 841.143.-- 841.144.-- 841.145.--	841.242.-- 841.243.-- 841.244.-- 841.245.--
-------------------------------------------------------------------------------------	--------------------------------------------------------------	------------------------------------------------------	------------------------------------------------------

Ensemble de 2 bureaux en vis à vis
Conjunto de 2 mesas enfrentadas
Composition of 2 Face to face desks

FINITIONS | ACABADOS | FINISHES

STRUCTURE / ESTRUCTURA / FRAME | PLATEAU / SOBRE / DESKTOP

	Argent Plata Silver RAL 9006		Blanc Blanco White		Gris Grey		Hêtre Haya Beech		Chêne Moyen Roble Maple
	Blanc Blanco White RAL 9016		Poirier Peral Pear		Wengué Wengue Wengue		Acacia Clair Acacia Clara Light Acacia		Acacia Foncé Acacia Oscura Dark Acacia
	Graphite Grafito Graphite		Chêne Veiné Castaño Claro Oak		Chêne Grisé Castaño Oscuro Dark Oak				

COMPLÉMENTS | COMPLEMENTOS | COMPLEMENTS

MODÈLE / VARIANTES / VERSIONS	DIMENSIONS / MEDIDAS / MEASUREMENTS	RÉFÉRENCE / REFERENCIA / CODE	
	80 x 9,8 x 11,4 cm	1.846.002.111	1.846.002.108

Goulotte individuelle
Bandeja electrificación individual
Cable tray

	Individuel / Individual / Single	846.693.111	846.693.108
	Double / Doble / Double	846.694.111	846.694.108

Support écran
Soporte pantalla
Monitor holder

FINITIONS | ACABADOS | FINISHES

STRUCTURE / ESTRUCTURA / FRAME

	Argent Plata Silver RAL 9006		Blanc Blanco White RAL 9016
---------------------------------------------------------------------------------------	---------------------------------------	---------------------------------------------------------------------------------------	--------------------------------------

CLOISONNETTES FRONTALES | PLAFONES | FRONT SCREENS

1 NIVEAU / 1 NIVEL / 1 LEVEL

2 NIVEAUX / 2 NIVELES / 2 LEVELS

MODÈLE / VARIANTES / VERSIONS	L.	RÉFÉRENCE / REFERENCIA / CODE	MODÈLE / VARIANTES / VERSIONS	L.	RÉFÉRENCE / REFERENCIA / CODE
	Indiv. / Indiv. / Single	RAL 9006 RAL 9016 386.008... 386.108... 386.009... 386.109... 386.010... 386.110... 386.011... 386.111...		Indiv. / Indiv. / Single	RAL 9006 RAL 9016 386.021... 386.121... 386.022... 386.122... 386.023... 386.123... 386.024... 386.124...
Mélamine Melamina Melamine			Mélamine Melamina Melamine		
FINITIONS ACABADOS FINISHES			FINITIONS ACABADOS FINISHES		
053 Blanc Blanco White	054 Gris Gris Grey	051 Argent Plata Silver	204 Graphite Grafito Graphite	088 Argent Plata Silver	
061 Chêne Moyen Roble Maple	062 Poirier Peral Pear	116 Wengué Wengue Wengue	081 Blanc Blanco White	197 Gris Gris Grey	
103 Acacia Clair Acacia Clara Light Acacia	104 Acacia Foncé Acacia Oscura Dark Acacia	272 Chêne Veiné Castaño Claro Oak	199 Chêne Moyen Roble Maple	200 Poirier Peral Pear	
273 Chêne Gris Castaño Oscuro Dark Oak			103 Acacia Clair Acacia Clara Light Acacia	104 Acacia Foncé Acacia Oscura Dark Acacia	
			235 Chêne Gris Castaño Oscuro Dark Oak		

MODÈLE / VARIANTES / VERSIONS	L.	RÉFÉRENCE / REFERENCIA / CODE
	Vis à vis / Enfrentadas / Face to face	180 cm 846.112... 846.212... 160 cm 846.114... 846.214... 140 cm 846.116... 846.216... 120 cm 846.118... 846.218...
Mélamine Melamina Melamine		

FINITIONS ACABADOS FINISHES	L.	RÉFÉRENCE / REFERENCIA / CODE
053 Blanc Blanco White	054 Gris Gris Grey	051 Argent Plata Silver
061 Chêne Moyen Roble Maple	062 Poirier Peral Pear	116 Wengué Wengue Wengue
103 Acacia Clair Acacia Clara Light Acacia	104 Acacia Foncé Acacia Oscura Dark Acacia	272 Chêne Veiné Castaño Claro Oak
273 Chêne Gris Castaño Oscuro Dark Oak		

MODÈLE / VARIANTES / VERSIONS	L.	RÉFÉRENCE / REFERENCIA / CODE
	Vis à vis / Enfrentadas / Face to face	180 cm 846.122... 846.222... 160 cm 846.124... 846.224... 140 cm 846.126... 846.226... 120 cm 846.128... 846.228...
Cloisonnette en méthacrylate et en mélamine - sans profilé en aluminium Metacrilato y melamina sin perfil de aluminio Methacrylate and melamine screen - without aluminium profile		

FINITIONS ACABADOS FINISHES	L.	RÉFÉRENCE / REFERENCIA / CODE
413 Blanc Blanco White	414 Gris Gris Grey	408 Graphite Grafito Graphite
416 Chêne Moyen Roble Maple	417 Poirier Peral Pear	409 Argent Plata Silver
626 Acacia Clair Acacia Clara Light Acacia	627 Acacia Foncé Acacia Oscura Dark Acacia	415 Hêtre Haya Beech
893 Chêne Gris Castaño Oscuro Dark Oak		418 Wengué Wengue Wengue

CLOISONNETTES FRONTALES | PLAFONES | FRONT SCREENS

1 NIVEAU / 1 NIVEL / 1 LEVEL

2 NIVEAUX / 2 NIVELES / 2 LEVELS

MODÈLE / VARIANTES / VERSIONS	L.	RÉFÉRENCE / REFERENCIA / CODE	MODÈLE / VARIANTES / VERSIONS	L.	RÉFÉRENCE / REFERENCIA / CODE
	Indiv. / Indiv. / Single	RAL 9006 RAL 9016 386.008.000 386.108.000 386.009.000 386.109.000 386.010.000 386.110.000 386.011.000 386.111.000		Indiv. / Indiv. / Single	RAL 9006 RAL 9016 386.021.000 386.121.000 386.022.000 386.122.000 386.023.000 386.123.000 386.024.000 386.124.000
Tissu Tapizado Upholstered			Tissu Tapizado Upholstered		
	Vis à vis / Enfrentadas / Face to face	180 cm 846.112.000 846.212.000 160 cm 846.114.000 846.214.000 140 cm 846.116.000 846.216.000 120 cm 846.118.000 846.218.000		Vis à vis / Enfrentadas / Face to face	180 cm 846.122.406 846.122.406 160 cm 846.124.406 846.124.406 140 cm 846.126.406 846.126.406 120 cm 846.128.406 846.128.406
Cloisonnette tissu - sans profilé en aluminium. Tapizado sin perfil de aluminio. Upholstered screen - without aluminium profile.			Cloisonnette en méthacrylate et en tissu - sans profilé en aluminium Metacrilato y tapizado sin perfil de aluminio Methacrylate and upholstered screen - without aluminium profile		

MODÈLE / VARIANTES / VERSIONS	L.	RÉFÉRENCE / REFERENCIA / CODE
	Cloisonnette avec profilé en aluminium / Con perfil de aluminio Screen with aluminium profile	180 cm 596.113.838 596.216.838 160 cm 596.114.838 596.217.838 140 cm 596.115.838 596.218.838 120 cm 596.123.838 596.223.838
Acoustique Acústico Acoustic		

FINITIONS ACABADOS FINISHES
Cf. page 464
Ver pagina 464
See page 464

MODÈLE / VARIANTES / VERSIONS	L.	RÉFÉRENCE / REFERENCIA / CODE
	Indiv. / Indiv. / Single	180 cm 386.008... 386.108... 160 cm 386.009... 386.109... 140 cm 386.010... 386.110... 120 cm 386.011... 386.111...
Méthacrylate Metacrilato Methacrylate		

FINITIONS ACABADOS FINISHES
411 Transparente Transparente Clear
412 Blanc opaque Translúcido Translucent

MODÈLE / VARIANTES / VERSIONS	L.	RÉFÉRENCE / REFERENCIA / CODE
	Indiv. / Indiv. / Single	180 cm 386.021... 386.121... 160 cm 386.022... 386.122... 140 cm 386.023... 386.123... 120 cm 386.024... 386.124...
Avec méthacrylate et tissu Con metacrilato y tapizado With methacrylate and upholstered		

FINITIONS ACABADOS FINISHES
406 Transparente Transparente Clear
427 Blanc opaque Translúcido Translucent
Cf. page 464
Ver pagina 464
See page 464

MOBILIER MODULAIRE
INSTALACIONES
DESK SYSTEMS



044 | STAR



056 | STAR RANGE



074 | BORN



086 | TEMPO



096 | ECO

star

La gamme STAR est le fruit de l'évolution de nos recherches et système de développement.

STAR es, sin duda, una apuesta de futuro en el desarrollo y evolución del mobiliario de oficina. Fruto de la evolución del sistema de desarrollo y estudio, nace este programa.

STAR is the future in office furniture. It was born as a result of ongoing research and development systems.

PLATEAU / SOBRE / DESK TOP

Mélamine / Melamina / Melamine: 25 mm
Stratifié / Estratificado / Stratified: 13 mm
Phénolique / Fenólico / Phenolic: 10 mm
Verre / Vidrio / Glass: 10 mm
Chant en ABS / Canto ABS / ABS edges

STRUCTURE / ESTRUCTURA / FRAME

Acier: 50 x 50 x 1,8 mm
Acero: 60 x 60 x 1,5 mm
Steel: 60 x 60 x 1,5 mm



prof./depth 80/60 prof./depth 100/120

FINITION STRUCTURE / ACABADO ESTRUCTURA / FRAME FINISH

Peinture époxy
Pintura epoxi
Epoxy paint

HAUTEUR / ALTURA / HEIGHT

73 cm

OPTION / OPCIÓN / OPTION

Voile de fond / Faldón / Modesty panel
Goulotte / Bandeja electrificación / Cable tray
Support écran / Soporte pantalla / Monitor holder
Cloisonnettes / Plafones / Screens

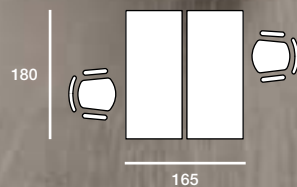

BUREAUX EN
VIS À VIS AVEC
PIÉTEMENT FERMÉ

MESAS
ENFRENTADAS CON
LATERAL CERRADO

FACE TO FACE
DESKS WITH
LOOP LEG

BUREAU
INDIVIDUEL AVEC
PIÉTEMENT OUVERT

MESA
CON LATERAL
ABIERTO

U-SHAPE
FRAME
TABLE



BUREAU
INDIVIDUEL
AVEC RETOUR

MESA
CON ALA

DESK WITH
RETURN

Combinable avec caissons et crédences.
Combinable con cajoneras y credencias.
Combine with pedestals and credenzas.

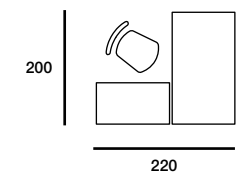
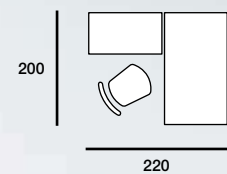



Plateau coulissant sur 14 cm.
El sobre puede deslizarse 14 cm.
Sliding top 14 cm.

BUREAUX
EN VIS À VIS
AVEC CRÉDENCE

MESAS
ENFRENTADAS
CON CREDENCIA

FACE TO FACE
DESKS WITH
SIDE CREDENZA

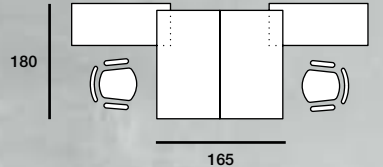



MODÈLES | VARIANTES | VERSIONS

PIÉTEMENT OUVERT / PATA ABIERTA / U-SHAPE LEG

MODÈLE / VARIANTES / VERSIONS	TYPE / TIPO / TYPE	DIMENSIONS / MEDIDAS / MEASUREMENTS	RÉFÉRENCE / REFERENCIA / CODE			
 <p>Bureau individuel Mesa individual Individual desks</p>		220 x 100 cm 200 x 100 cm	351.100.-.. 351.101.-..	351.200.-.. 351.201.-..	351.300.-.. 351.301.-..	
		180 x 80 cm 160 x 80 cm 140 x 80 cm 120 x 80 cm 100 x 80 cm 80 x 80 cm	351.102.-.. 351.103.-.. 351.104.-.. 351.105.-.. 351.106.-.. 351.107.-..	351.202.-.. 351.203.-.. 351.204.-.. 351.205.-.. 351.206.-.. 351.207.-..	351.302.-.. 351.303.-.. 351.304.-.. 351.305.-.. 351.306.-.. 351.307.-..	
	 <p>Bureau individuel pour crédence Mesa individual con credencia Individual desks with side credenza</p>	À Droite / Derecha / Right	160 x 160 cm 200 x 100 cm 180 x 80 cm 160 x 80 cm	351.132.-.. 351.134.-.. 351.136.-.. 351.138.-..	351.232.-.. 351.234.-.. 351.236.-.. 351.238.-..	351.332.-.. 351.334.-.. 351.336.-.. 351.338.-..
		À Gauche / Izquierda / Left	160 x 160 cm 200 x 100 cm 180 x 80 cm 160 x 80 cm	351.133.-.. 351.135.-.. 351.137.-.. 351.139.-..	351.233.-.. 351.235.-.. 351.237.-.. 351.239.-..	351.333.-.. 351.335.-.. 351.337.-.. 351.339.-..
			360 x 80 cm 320 x 80 cm 280 x 80 cm 240 x 80 cm 200 x 80 cm 160 x 80 cm	351.108.-.. 351.109.-.. 351.110.-.. 351.111.-.. 351.112.-.. 351.113.-..	351.208.-.. 351.209.-.. 351.210.-.. 351.211.-.. 351.212.-.. 351.213.-..	351.308.-.. 351.309.-.. 351.310.-.. 351.311.-.. 351.312.-.. 351.313.-..
	 <p>Bureaux alignés Mesas lineales Side by side desks</p>		Type "A" / Tipo "A" / Type "A"	351.120.-.. 351.121.-.. 351.122.-.. 351.123.-..	351.220.-.. 351.221.-.. 351.222.-.. 351.223.-..	351.320.-.. 351.321.-.. 351.322.-.. 351.323.-..
		4 bureaux / mesas / desktops	Type "B" / Tipo "B" / Type "B"	358.120.-.. 358.121.-.. 358.122.-.. 358.123.-..	358.220.-.. 358.221.-.. 358.222.-.. 358.223.-..	358.320.-.. 358.321.-.. 358.322.-.. 358.323.-..
 <p>Bureaux en vis à vis Mesas enfrentadas Face to face desks</p>		2 bureaux / mesas / desktops	Type "A" / Tipo "A" / Type "A"	351.128.-.. 351.129.-.. 351.130.-.. 351.131.-..	351.228.-.. 351.229.-.. 351.230.-.. 351.231.-..	351.328.-.. 351.329.-.. 351.330.-.. 351.331.-..
			Type "B" / Tipo "B" / Type "B"	358.128.-.. 358.129.-.. 358.130.-.. 358.131.-..	358.228.-.. 358.229.-.. 358.230.-.. 358.231.-..	358.328.-.. 358.329.-.. 358.330.-.. 358.331.-..
			Type "A" / Tipo "A" / Type "A"	351.140.-.. 351.141.-.. 351.142.-..	351.240.-.. 351.241.-.. 351.242.-..	351.340.-.. 351.341.-.. 351.342.-..
 <p>Bureaux en vis à vis pour crédence Mesas enfrentadas para credencia Face to face desks with side credenza</p>		4 bureaux / mesas / desktops	Type "B" / Tipo "B" / Type "B"	358.140.-.. 358.141.-.. 358.142.-..	358.240.-.. 358.241.-.. 358.242.-..	358.340.-.. 358.341.-.. 358.342.-..
	2 bureaux / mesas / desktops	Type "A" / Tipo "A" / Type "A"	351.143.-.. 351.144.-.. 351.145.-..	351.243.-.. 351.244.-.. 351.245.-..	351.343.-.. 351.344.-.. 351.345.-..	
		Type "B" / Tipo "B" / Type "B"	358.143.-.. 358.144.-.. 358.145.-..	358.243.-.. 358.244.-.. 358.245.-..	358.343.-.. 358.344.-.. 358.345.-..	

PIÉTEMENT FERMÉ / PATA CERRADA / LOOP LEGS

MODÈLE / VARIANTES / VERSIONS	TYPE / TIPO / TYPE	DIMENSIONS / MEDIDAS / MEASUREMENTS	RÉFÉRENCE / REFERENCIA / CODE		
 <p>Bureau individuel Mesa individual Individual desks</p>		220 x 100 cm 200 x 100 cm	357.100.-.. 357.101.-..	357.200.-.. 357.201.-..	357.300.-.. 357.301.-..
		180 x 80 cm 160 x 80 cm 140 x 80 cm	357.102.-.. 357.103.-.. 357.104.-..	357.202.-.. 357.203.-.. 357.204.-..	357.302.-.. 357.303.-.. 357.304.-..
 <p>Bureaux en vis à vis Mesas enfrentadas Face to face desks</p>	4 bureaux / mesas / desktops	Type "A" / Tipo "A" / Type "A"	357.107.-.. 357.108.-.. 357.109.-.. 357.110.-..	357.207.-.. 357.208.-.. 357.209.-.. 357.210.-..	357.307.-.. 357.308.-.. 357.309.-.. 357.310.-..
		Type "B" / Tipo "B" / Type "B"	359.107.-.. 359.108.-.. 359.109.-.. 359.110.-..	359.207.-.. 359.208.-.. 359.209.-.. 359.210.-..	359.307.-.. 359.308.-.. 359.309.-.. 359.310.-..
	2 bureaux / mesas / desktops	Type "A" / Tipo "A" / Type "A"	357.115.-.. 357.116.-.. 357.117.-.. 357.118.-..	357.215.-.. 357.216.-.. 357.217.-.. 357.218.-..	357.315.-.. 357.316.-.. 357.317.-.. 357.318.-..
		Type "B" / Tipo "B" / Type "B"	359.115.-.. 359.116.-.. 359.117.-.. 359.118.-..	359.215.-.. 359.216.-.. 359.217.-.. 359.218.-..	359.315.-.. 359.316.-.. 359.317.-.. 359.318.-..
			Type "A" / Tipo "A" / Type "A"	357.119.-.. 357.120.-.. 357.121.-..	357.219.-.. 357.220.-.. 357.221.-..
	2 bureaux / mesas / desktops	Type "B" / Tipo "B" / Type "B"	359.119.-.. 359.120.-.. 359.121.-..	359.219.-.. 359.220.-.. 359.221.-..	359.319.-.. 359.320.-.. 359.321.-..

FINITIONS | ACABADOS | FINISHES

STRUCTURE / ESTRUCTURA / FRAME | PLATEAU / SOBRE / DESKTOP

TYPE / TIPO / TYPE A

Structure pour cloisonnettes / Apta para plafones / Screens available

TYPE / TIPO / TYPE B

Structure sans cloisonnettes / No apta para plafones / Screens no available

 Argent Plata Silver RAL 9006	 053 Blanc Blanco White	 054 Gris Gris Grey	 055 Hêtre Haya Beech	 061 Chêne Moyen Roble Maple
 RAL 9016	 062 Poirier Peral Pear	 116 Wengué Wengue Wengue	 103 Acacia Clair Acacia Clara Light Acacia	 104 Acacia Foncé Acacia Oscura Dark Acacia
 RAL 7022	 007 Graphite Grafito Graphite	 272 Chêne Veiné Castaño Claro Oak	 273 Chêne Gris Castaño Oscuro Dark Oak	

COMPLÉMENTS | COMPLEMENTOS | COMPLEMENTS

MODÈLE / VARIANTES / VERSIONS	DIMENSIONS / MEDIDAS / MEASUREMENTS	RÉFÉRENCE / REFERENCIA / CODE		
	120 x 60 cm 80 x 60 cm	351.191... 351.190...	351.291... 351.290...	351.391... 351.390...
	120 x 60 cm 80 x 60 cm	357.191... 357.190...	357.291... 357.290...	357.391... 357.390...
	158 x 118 cm	351.196...	351.296...	351.396...
	80 x 40 cm	351.197...	351.297...	351.397...
	165 x 70 cm	351.198...	351.298...	351.398...
	165 x 40 cm	351.199...	351.299...	351.399...

FINITIONS | ACABADOS | FINISHES

STRUCTURE / ESTRUCTURA / FRAME | PLATEAU / SOBRE / DESKTOP

COMPLÉMENTS | COMPLEMENTOS | COMPLEMENTS

MODÈLE / VARIANTES / VERSIONS	DIMENSIONS / MEDIDAS / MEASUREMENTS	RÉFÉRENCE / REFERENCIA / CODE		
	Mélamine / Melamina / Melamine 220 cm 200 cm 180 cm 160 cm 140 cm 120 cm 100 cm 80 cm	1.351.702.051 1.351.704.051 1.351.706.051 1.351.708.051 1.351.710.051 1.351.712.051 1.351.714.051 1.351.716.051	1.351.702.053 1.351.704.053 1.351.706.053 1.351.708.053 1.351.710.053 1.351.712.053 1.351.714.053 1.351.716.053	1.351.702.007 1.351.704.007 1.351.706.007 1.351.708.007 1.351.710.007 1.351.712.007 1.351.714.007 1.351.716.007
	Métal / Metal / Metal 220 cm 200 cm 180 cm 160 cm 140 cm 120 cm 100 cm 80 cm	1.351.720.111 1.351.721.111 1.351.722.111 1.351.723.111 1.351.724.111 1.351.725.111 1.351.726.111 1.351.727.111	1.351.720.108 1.351.721.108 1.351.722.108 1.351.723.108 1.351.724.108 1.351.725.108 1.351.726.108 1.351.727.108	1.351.720.107 1.351.721.107 1.351.722.107 1.351.723.107 1.351.724.107 1.351.725.107 1.351.726.107 1.351.727.107
	Pour bureaux / para mesas / for desks: 220 cm 200 cm 180 cm 160 cm 140 cm 120 cm 100 cm 80 cm	1.356.300.111 1.356.301.111 1.356.302.111 1.356.303.111 1.356.304.111 1.356.305.111 1.356.306.111 1.356.307.111	1.356.300.108 1.356.301.108 1.356.302.108 1.356.303.108 1.356.304.108 1.356.305.108 1.356.306.108 1.356.307.108	1.356.300.107 1.356.301.107 1.356.302.107 1.356.303.107 1.356.304.107 1.356.305.107 1.356.306.107 1.356.307.107
	Pour tables de réunion et bureaux en vis à vis / Para mesas de reunión y enfrentadas / For meeting tables and face to face desks 250 cm 200 cm 180 cm 160 cm 140 / 150 cm 120 100 80	1.356.310.111 1.356.311.111 1.356.312.111 1.356.313.111 1.356.314.111 1.356.315.111 1.356.316.111 1.356.317.111	1.356.310.108 1.356.311.108 1.356.312.108 1.356.313.108 1.356.314.108 1.356.315.108 1.356.316.108 1.356.317.108	1.356.310.301 1.356.311.301 1.356.312.301 1.356.313.301 1.356.314.301 1.356.315.301 1.356.316.301 1.356.317.301
	Individuel / Individual / Single Double / Doble / Double	846.693.111	846.693.108	
	Support écran Soporte pantalla Monitor holder	846.694.111	846.694.108	

FINITIONS | ACABADOS | FINISHES

STRUCTURE / ESTRUCTURA / FRAME

--	--	--

CLOISONNETTES FRONTALES | PLAFONES | FRONT SCREENS

1 NIVEAU / 1 NIVEL / 1 LEVEL

2 NIVEAUX / 2 NIVELES / 2 LEVELS

MODÈLE / VARIANTES / VERSIONS	L.	RÉFÉRENCE / REFERENCIA / CODE		
	Indiv. / Individ. / Single	RAL 9006	RAL 9016	RAL 7022
	180 cm	356.001.-	356.101.-	356.201.-
	160 cm	356.002.-	356.102.-	356.202.-
	140 cm	356.003.-	356.103.-	356.203.-
	120 cm	356.004.-	356.104.-	356.204.-
	100 cm	356.005.-	356.105.-	356.205.-
	80 cm	356.006.-	356.106.-	356.206.-
Vis à vis / Enfrentadas / Face to face	180 cm	356.007.-	356.107.-	356.207.-
	160 cm	356.008.-	356.108.-	356.208.-
	140 cm	356.009.-	356.109.-	356.209.-
	120 cm	356.010.-	356.110.-	356.210.-
	100 cm	356.011.-	356.111.-	356.211.-
	100 cm	356.012.-	356.112.-	356.212.-
	80 cm	356.012.-	356.112.-	356.212.-

FINITIONS ACABADOS FINISHES

007 Graphite Grafito Graphite	051 Argent Plata Silver
053 Blanc Blanco White	054 Gris Gris Grey
055 Hêtre Haya Beech	061 Chêne Moyen Roble Maple
062 Poirier Peral Pear	116 Wengué Wengue Wengue
103 Acacia Clair Acacia Clara Light Acacia	104 Acacia Foncé Acacia Oscura Dark Acacia
272 Chêne Veiné Castaño Claro Oak	273 Chêne Grisé Castaño Oscuro Dark Oak

FINITIONS ACABADOS FINISHES

204 Graphite Grafito Graphite	088 Argent Plata Silver
081 Blanc Blanco White	197 Gris Gris Grey
198 Hêtre Haya Beech	199 Chêne Moyen Roble Maple
200 Poirier Peral Pear	202 Wengué Wengue Wengue
103 Acacia Clair Acacia Clara Light Acacia	104 Acacia Foncé Acacia Oscura Dark Acacia
209 Chêne Veiné Castaño Claro Oak	235 Chêne Grisé Castaño Oscuro Dark Oak



CLOISONNETTES FRONTALES | PLAFONES | FRONT SCREENS

1 NIVEAU / 1 NIVEL / 1 LEVEL

2 NIVEAUX / 2 NIVELES / 2 LEVELS

MODÈLE / VARIANTES / VERSIONS	L.	RÉFÉRENCE / REFERENCIA / CODE		
	Indiv. / Individ. / Single	RAL 9006	RAL 9016	RAL 7022
	180 cm	356.001.000	356.101.000	356.201.000
	160 cm	356.002.000	356.102.000	356.202.000
	140 cm	356.003.000	356.103.000	356.203.000
	120 cm	356.004.000	356.104.000	356.204.000
	100 cm	356.005.000	356.105.000	356.205.000
	80 cm	356.006.000	356.106.000	356.206.000
Vis à vis / Enfrentadas / Face to face	180 cm	356.007.000	356.107.000	356.207.000
	160 cm	356.008.000	356.108.000	356.208.000
	140 cm	356.009.000	356.109.000	356.209.000
	120 cm	356.010.000	356.110.000	356.210.000
	100 cm	356.011.000	356.111.000	356.211.000
	100 cm	356.012.000	356.112.000	356.212.000
	80 cm	356.012.000	356.112.000	356.212.000

FINITIONS ACABADOS FINISHES

411 Transparent Transparente Clear	412 Blanc opaque Translúcido Translucent
406 Transparent Transparente Clear	427 Blanc opaque Translúcido Translucent

FINITIONS ACABADOS FINISHES

411 Transparent Transparente Clear	412 Blanc opaque Translúcido Translucent
406 Transparent Transparente Clear	427 Blanc opaque Translúcido Translucent

FINITIONS ACABADOS FINISHES

411 Transparent Transparente Clear	412 Blanc opaque Translúcido Translucent
-------------------------------------------------	-------------------------------------------------------

FINITIONS ACABADOS FINISHES

411 Transparent Transparente Clear	412 Blanc opaque Translúcido Translucent
406 Transparent Transparente Clear	427 Blanc opaque Translúcido Translucent

FINITIONS ACABADOS FINISHES

411 Transparent Transparente Clear	412 Blanc opaque Translúcido Translucent
406 Transparent Transparente Clear	427 Blanc opaque Translúcido Translucent

FINITIONS ACABADOS FINISHES

411 Transparent Transparente Clear	412 Blanc opaque Translúcido Translucent
-------------------------------------------------	-------------------------------------------------------

star
range

Cloisonnettes de 1 et 2 niveaux, acoustiques et avec rails pour y accrocher une grande variété d'accessoires et rendre votre poste de travail plus agréable.

Esta ampliación de la serie STAR facilita el crear un espacio de trabajo más cómodo. Separadores de uno y dos niveles, acústicos y con guías junto a una gran variedad de accesorios para hacer de las oficinas un lugar más agradable.

Best accessories to do more comfortable the workstation: one or two levels front screens (acoustics or with guide), toolbar with complements and a wide range of facilities that will make the workspace a better place.

MODULE / MÓDULO / LOW STORAGE

Mélamine / Melamina / Melamine: 25 mm
Stratifié / Estratificado / Stratified: 25 mm
Phenolique / Fenólico / Phenolic: 13 mm

Chant en ABS / Canto ABS / ABS edges

STRUCTURE / ESTRUCTURA / FRAME

Acier: 50 x 50 x 1,8 mm
Steel: 50 x 50 x 1,8 mm



FINITION STRUCTURE / ACABADO ESTRUCTURA / FRAME FINISH

Peinture époxy
Pintura epoxi
Epoxy paint

HAUTEUR / ALTURA / HEIGHT

Module simple		Avec rangement supérieur
Módulo	58,1 cm	Con altillo
Low storage		High storage
		139,1 cm

OPTION / OPCIÓN / OPTION

Voile de fond / Faldón / Modesty panel
Goulotte / Bandeja electrificación / Cable tray
Cloisonnettes / Plafones / Screens



MEUBLE DE
RANGEMENT DOUBLE

MÓDULO
DOBLE

TWO FACES
LOW STORAGE

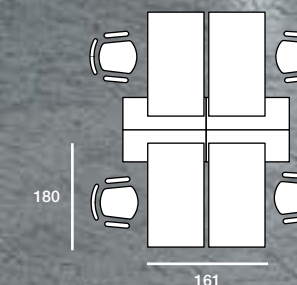



Tiroir DS disponible.
Cajón archivo disponible.
File drawer available.



Poignée standard / Tirador estándar / Standard handle

Poignée en option / Tirador opcional / Optional handle

Poignée à choisir.
Tirador a escoger.
2 handle types.

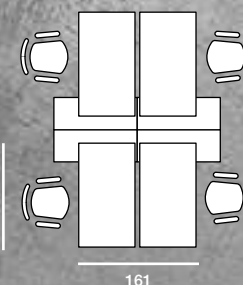

MEUBLE AVEC
RANGEMENT SUPÉRIEUR

MÓDULO
CON ALTILLO

LOW AND HIGH
STORAGE

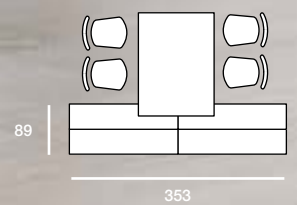

MEUBLE DE
RANGEMENT INDIVIDUEL

MÓDULO
INDIVIDUAL

INDIVIDUAL LOW
STORAGE

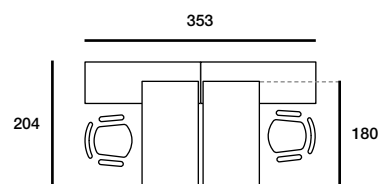



| CLOISONNETTES

| DIVISORIAS

| FRONT SCREENS

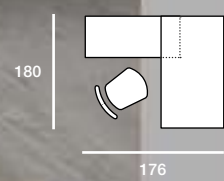

MODÈLES | VARIANTES | VERSIONS

PIÉTEMENT OUVERT / PATA ABIERTA / U-SHAPE LEG

MODÈLE / VARIANTES / VERSIONS	TYPE / TIPO / TYPE	DIMENSIONS / MEDIDAS / MEASUREMENTS	RÉFÉRENCE / REFERENCIA / CODE		
			■	■	■
	À droite / Derecha / Right	180 x 80 cm 160 x 80 cm 140 x 80 cm	353.102... 353.104... 353.106...	353.202... 353.204... 353.206...	353.302... 353.304... 353.306...
	À gauche / Izquierda / Left	180 x 80 cm 160 x 80 cm 140 x 80 cm	353.103... 353.105... 353.107...	353.203... 353.205... 353.207...	353.303... 353.305... 353.307...
	À droite / Derecha / Right	180 x 60 cm 160 x 60 cm 140 x 60 cm	353.112... 353.114... 353.116...	353.212... 353.214... 353.216...	353.312... 353.314... 353.316...
	À gauche / Izquierda / Left	180 x 60 cm 160 x 60 cm 140 x 60 cm	353.113... 353.115... 353.117...	353.213... 353.215... 353.217...	353.313... 353.315... 353.317...

Bureau individuel
Mesa individual
Individual desks

	180 x 165 cm 160 x 165 cm 140 x 165 cm	353.120... 353.122... 353.124...	353.220... 353.222... 353.224...	353.320... 353.322... 353.324...
	180 x 125 cm 160 x 125 cm 140 x 125 cm	353.126... 353.128... 353.130...	353.226... 353.228... 353.230...	353.326... 353.328... 353.330...

Bureaux en vis à vis
Mesas enfrentadas
Face to face desks

	180 x 160 cm 160 x 160 cm 140 x 160 cm	353.132... 353.134... 353.136...	353.232... 353.234... 353.236...	353.332... 353.334... 353.336...
	180 x 120 cm 160 x 120 cm 140 x 120 cm	353.138... 353.140... 353.142...	353.238... 353.240... 353.242...	353.338... 353.340... 353.342...

Bureaux doubles en 1 seul plateau
Mesa doble con 1 solo sobre
Meeting table

MODÈLES | VARIANTES | VERSIONS

PIÉTEMENT FERMÉ / PATA CERRADA / LOOP LEGS

MODÈLE / VARIANTES / VERSIONS	TYPE / TIPO / TYPE	DIMENSIONS / MEDIDAS / MEASUREMENTS	RÉFÉRENCE / REFERENCIA / CODE		
			■	■	■
	À droite / Derecha / Right	180 x 80 cm 160 x 80 cm 140 x 80 cm	357.132... 357.134... 357.136...	357.232... 357.234... 357.236...	357.332... 357.334... 357.336...
	À gauche / Izquierda / Left	180 x 80 cm 160 x 80 cm 140 x 80 cm	357.133... 357.135... 357.137...	357.233... 357.235... 357.237...	357.333... 357.335... 357.337...
	À droite / Derecha / Right	180 x 60 cm 160 x 60 cm 140 x 60 cm	357.142... 357.144... 357.146...	357.242... 357.244... 357.246...	357.342... 357.344... 357.346...
	À gauche / Izquierda / Left	180 x 60 cm 160 x 60 cm 140 x 60 cm	357.143... 357.145... 357.147...	357.243... 357.245... 357.247...	357.343... 357.345... 357.347...

Bureau individuel
Mesa individual
Individual desks

	180 x 165 cm 160 x 165 cm 140 x 165 cm	357.154... 357.155... 357.156...	357.254... 357.255... 357.256...	357.354... 357.355... 357.356...
	180 x 125 cm 160 x 125 cm 140 x 125 cm	357.157... 357.158... 357.159...	357.257... 357.258... 357.259...	357.357... 357.358... 357.359...















Bureaux en vis à vis
Mesas enfrentadas
Face to face desks

	180 x 160 cm 160 x 160 cm 140 x 160 cm	357.162... 357.164... 357.166...	357.262... 357.264... 357.266...	357.362... 357.364... 357.366...
	180 x 120 cm 160 x 120 cm 140 x 120 cm	357.168... 357.170... 357.172...	357.268... 357.270... 357.272...	357.368... 357.370... 357.372...

Bureaux doubles en 1 seul plateau
Mesa doble con 1 solo sobre
Meeting table















FINITIONS | ACABADOS | FINISHES

STRUCTURE / ESTRUCTURA / FRAME | PLATEAU / SOBRE / DESKTOP

 Argent Plata Silver	 Blanc Blanco White	 Gris Gris Grey	 Hêtre Haya Beech	 Chêne Moyen Roble Maple
 Blanc Blanco White	 Poirier Peral Pear	 Wengué Wengue Wengue	 Acacia Clair Acacia Clara Light Acacia	 Acacia Foncé Acacia Oscura Dark Acacia
 Graphite Grafito Graphite	 Graphite Grafito Graphite	 Chêne Veiné Castaño Claro Oak	 Chêne Gris Castaño Oscuro Dark Oak	

FINITIONS | ACABADOS | FINISHES

STRUCTURE / ESTRUCTURA / FRAME | PLATEAU / SOBRE / DESKTOP

 Argent Plata Silver	 Blanc Blanco White	 Gris Gris Grey	 Hêtre Haya Beech	 Chêne Moyen Roble Maple
 Blanc Blanco White	 Poirier Peral Pear	 Wengué Wengue Wengue	 Acacia Clair Acacia Clara Light Acacia	 Acacia Foncé Acacia Oscura Dark Acacia
 Graphite Grafito Graphite	 Graphite Grafito Graphite	 Chêne Veiné Castaño Claro Oak	 Chêne Gris Castaño Oscuro Dark Oak	

MODÈLES | VARIANTES | VERSIONS

MEUBLE DE RANGEMENT / MÓDULOS / LOW STORAGE

MODÈLE / VARIANTES / VERSIONS	TYPE / TIPO / TYPE	DIMENSIONS / MEDIDAS / MEASUREMENTS	RÉFÉRENCE / REFERENCIA / CODE		
	Individuel / Individual / Single face		2 Tiroirs / Cajones / Drawers + 1 Porte coulissante / Puerta corredera / Sliding door	2 DS / Archivo / File + 1 Porte coulissante / Puerta corredera / Sliding door	2 Portes coulissantes / Puertas correderas / Sliding doors
	À droite / Derecha / Right	176,4 x 44,5 cm	362.001.-.-	362.003.-.-	362.005.-.-
	À gauche / Izquierda / Left	176,4 x 44,5 cm	362.002.-.-	362.004.-.-	
			4 Tiroirs / Cajones / Drawers + 2 Portes coulissantes / Puertas correderas / Sliding doors	2 DS / Archivo / File + 2 Portes coulissantes / Puertas correderas / Sliding doors	4 Portes coulissantes / Puertas correderas / Sliding doors
Type 1 Tipo 1 Type 1	Double / Doble / Two faces	176,4 x 89 cm	362.010.-.-	362.011.-.-	362.012.-.-
	Individuel / Individual / Single face		2 Tiroirs / Cajones / Drawers + 1 Porte coulissante / Puerta corredera / Sliding door	2 DS / Archivo / File + 1 Porte coulissante / Puerta corredera / Sliding door	2 Portes coulissantes / Puertas correderas / Sliding doors
	À droite / Derecha / Right	176,4 x 44,5 cm	362.030.-.-	362.032.-.-	362.034.-.-
	À gauche / Izquierda / Left	176,4 x 44,5 cm	362.031.-.-	362.033.-.-	
			4 Tiroirs / Cajones / Drawers + 2 Portes coulissantes / Puertas correderas / Sliding doors	2 DS / Archivo / File + 2 Portes coulissantes / Puertas correderas / Sliding doors	4 Portes coulissantes / Puertas correderas / Sliding doors
Type 2 Tipo 2 Type 2	Double / Doble / Two faces	176,4 x 89 cm	362.036.-.-	362.037.-.-	362.038.-.-
	Individuel / Individual / Single face		2 Tiroirs / Cajones / Drawers + 1 Porte coulissante / Puerta corredera / Sliding door	2 DS / Archivo / File + 1 Porte coulissante / Puerta corredera / Sliding door	2 Portes coulissantes / Puertas correderas / Sliding doors
	À droite / Derecha / Right	176,4 x 44,5 cm	362.040.-.-	362.042.-.-	362.044.-.-
	À gauche / Izquierda / Left	176,4 x 44,5 cm	362.041.-.-	362.043.-.-	
			4 Tiroirs / Cajones / Drawers + 2 Portes coulissantes / Puertas correderas / Sliding doors	2 DS / Archivo / File + 2 Portes coulissantes / Puertas correderas / Sliding doors	4 Portes coulissantes / Puertas correderas / Sliding doors
Type 3 (avec goulotte) Tipo 3 (con canal electrificación) Type 3 (with cable cover)	Double / Doble / Two faces	176,4 x 89 cm	362.050.-.-	362.051.-.-	362.052.-.-

MODÈLES | VARIANTES | VERSIONS

MEUBLES DE RANGEMENT SUPÉRIEURS / ALTILLOS PARA MÓDULOS / HIGH STORAGE

MODÈLE / VARIANTES / VERSIONS	TYPE / TIPO / TYPE	DIMENSIONS / MEDIDAS / MEASUREMENTS	RÉFÉRENCE / REFERENCIA / CODE	
	Individuel / Individual / Single face	176,4 x 34,8 cm	Support ouvert / Soporte abierto / L-Shape supports	Support fermé / Soporte cerrado / U-Shape support
			362.020.-.-	362.021.-.-
	Double / Doble / Two faces	176,4 x 67 cm	362.022.-.-	362.023.-.-





Meubles de rangement supérieurs
Altillos para módulos
High storage

FINITIONS | ACABADOS | FINISHES

STRUCTURE / ESTRUCTURA / FRAME | PORTES COULISSANTES / PUERTAS CORREDERAS / SLIDING DOORS

Argent Plata Silver	075	Blanc Blanco White	054	Gris Gris Grey	055	Hêtre Haya Beech	061	Chêne Moyen Roble Maple	062	Poirier Peral Pear
	116	Wengué Wengue Wengue	694	Acacia Clair Acacia Clara Light Acacia	695	Acacia Foncé Acacia Oscura Dark Acacia	125	Graphite Grafito Graphite	272	Chêne Veiné Castaño Claro Oak
	273	Chêne Grisé Castaño Oscuro Dark Oak								
Blanc Blanco White	088	Argent Plata Silver	076	Gris Gris Grey	077	Hêtre Haya Beech	078	Chêne Moyen Roble Maple	079	Poirier Peral Pear
	080	Wengué Wengue Wengue	168	Acacia Clair Acacia Clara Light Acacia	169	Acacia Foncé Acacia Oscura Dark Acacia	115	Graphite Grafito Graphite	043	Chêne Veiné Castaño Claro Oak
	106	Chêne Grisé Castaño Oscuro Dark Oak								
Graphite Grafito Graphite	228	Argent Plata Silver	229	Blanc Blanco White	230	Gris Gris Grey	231	Hêtre Haya Beech	232	Chêne Moyen Roble Maple
	234	Poirier Peral Pear	700	Acacia Clair Acacia Clara Light Acacia	701	Acacia Foncé Acacia Oscura Dark Acacia	251	Chêne Veiné Castaño Claro Oak	252	Chêne Grisé Castaño Oscuro Dark Oak
Monochrome Monocolor Single-colour	051	Argent Plata Silver	053	Blanc Blanco White	197	Gris Gris Grey	198	Hêtre Haya Beech	199	Chêne Moyen Roble Maple
	200	Poirier Peral Pear	202	Wengué Wengue Wengue	103	Acacia Clair Acacia Clara Light Acacia	104	Acacia Foncé Acacia Oscura Dark Acacia	204	Graphite Grafito Graphite
	209	Chêne Veiné Castaño Claro Oak	235	Chêne Grisé Castaño Oscuro Dark Oak						

| COMPLÉMENTS | COMPLEMENTOS | COMPLEMENTS

MODÈLE / VARIANTES / VERSIONS	DIMENSIONS / MEDIDAS / MEASUREMENTS	RÉFÉRENCE / REFERENCIA / CODE			
	Mélamine / Melamina / Melamine	180 cm 160 cm 140 cm	 1.351.708.051  1.351.710.051  1.351.712.051	1.351.708.053 1.351.710.053 1.351.712.053	1.351.708.007 1.351.710.007 1.351.712.007
	Métal / Metal / Metal	180 cm 160 cm 140 cm	1.351.723.111 1.351.724.111 1.351.725.111	1.351.723.108 1.351.724.108 1.351.725.108	1.351.723.107 1.351.724.107 1.351.725.107

	Pour bureaux / para mesas / for desks:	180 cm 160 cm 140 cm	Indiv. / Individ. / Single		
			1.356.303.111 1.356.304.111 1.356.305.111	1.356.303.108 1.356.304.108 1.356.305.108	1.356.303.107 1.356.304.107 1.356.305.107
	Pour tables de réunion et vis à vis / para mesas de reunión y enfrentadas / for meeting tables and face to face desks	180 cm 160 cm 140 cm	Double / Doble / Double		
			1.356.313.111 1.356.314.111 1.356.315.111	1.356.313.108 1.356.314.108 1.356.315.108	1.356.313.107 1.356.314.107 1.356.315.107

| FINITIONS | ACABADOS | FINISHES

STRUCTURE / ESTRUCTURA / FRAME

 Argent Plata Silver	 Blanc Blanco White	 Graphite Grafito Graphite
RAL 9006	RAL 9016	RAL 7022





| CLOISONNETTES FRONTALES | PLAFONES | FRONT SCREENS

1 NIVEAU / 1 NIVEL / 1 LEVEL

MODÈLE / VARIANTES / VERSIONS	L.	RÉFÉRENCE / REFERENCIA / CODE		
		 RAL 9006	 RAL 9016	 RAL 7022
	Indiv. / Individ. / Single			
	180 cm	356.054.-.-	356.154.-.-	356.254.-.-
	160 cm	356.055.-.-	356.155.-.-	356.255.-.-
	140 cm	356.056.-.-	356.156.-.-	356.256.-.-
	Vis à vis / Enfrentadas / Face to face			
	180 cm	356.057.-.-	356.157.-.-	356.257.-.-
	160 cm	356.058.-.-	356.158.-.-	356.258.-.-
	140 cm	356.059.-.-	356.159.-.-	356.259.-.-













Mélamine
Melamina
Melamine

2 NIVEAUX / 2 NIVELES / 2 LEVELS













MODÈLE / VARIANTES / VERSIONS	L.	RÉFÉRENCE / REFERENCIA / CODE		
		 RAL 9006	 RAL 9016	 RAL 7022
	Indiv. / Individ. / Single			
	180 cm	356.064.-.-	356.164.-.-	356.264.-.-
	160 cm	356.065.-.-	356.165.-.-	356.265.-.-
	140 cm	356.066.-.-	356.166.-.-	356.266.-.-
	Vis à vis / Enfrentadas / Face to face			
	180 cm	356.067.-.-	356.167.-.-	356.267.-.-
	160 cm	356.068.-.-	356.168.-.-	356.268.-.-
	140 cm	356.069.-.-	356.169.-.-	356.269.-.-

Mélamine
Melamina
Melamine

FINITIONS ACABADOS FINISHES

 Graphite Grafito Graphite	 Argent Plata Silver	
 Blanc Blanco White	 Gris Gris Grey	 Hêtre Haya Beech
 Chêne Moyen Roble Maple	 Poirier Peral Pear	 Wengué Wengue Wengue
 Acacia Clair Acacia Clara Light Acacia	 Acacia Foncé Acacia Oscura Dark Acacia	 Chêne Veiné Castaño Claro Oak
 Chêne Gris Castaño Oscuro Dark Oak		

FINITIONS ACABADOS FINISHES

 Graphite Grafito Graphite	 Argent Plata Silver	
 Blanc Blanco White	 Gris Gris Grey	 Hêtre Haya Beech
 Chêne Moyen Roble Maple	 Poirier Peral Pear	 Wengué Wengue Wengue
 Acacia Clair Acacia Clara Light Acacia	 Acacia Foncé Acacia Oscura Dark Acacia	 Chêne Veiné Castaño Claro Oak
 Chêne Gris Castaño Oscuro Dark Oak		

CLOISONNETTES FRONTALES | PLAFONES | FRONT SCREENS

1 NIVEAU / 1 NIVEL / 1 LEVEL

2 NIVEAUX / 2 NIVELES / 2 LEVELS

MODÈLE / VARIANTES / VERSIONS	L.	RÉFÉRENCE / REFERENCIA / CODE			MODÈLE / VARIANTES / VERSIONS	L.	RÉFÉRENCE / REFERENCIA / CODE			
		RAL 9006	RAL 9016	RAL 7022			RAL 9006	RAL 9016	RAL 7022	
	Indiv. / Individ. / Single					Indiv. / Individ. / Single				
	180 cm	356.054.000	356.154.000	356.254.000		180 cm	356.064.000	356.164.000	356.264.000	
	160 cm	356.055.000	356.155.000	356.255.000		160 cm	356.065.000	356.165.000	356.265.000	
	140 cm	356.056.000	356.156.000	356.256.000		140 cm	356.066.000	356.166.000	356.266.000	
	Vis à vis / Enfrentadas / Face to face					Vis à vis / Enfrentadas / Face to face				
	180 cm	356.057.000	356.157.000	356.257.000		180 cm	356.067.000	356.167.000	356.267.000	
	160 cm	356.058.000	356.158.000	356.258.000		160 cm	356.068.000	356.168.000	356.268.000	
	140 cm	356.059.000	356.159.000	356.259.000		140 cm	356.069.000	356.169.000	356.269.000	
	Tissu Tapizado Upholstered					Tissu Tapizado Upholstered				

FINITIONS
ACABADOS
FINISHES

Cf. page 464
Ver pagina 464
See page 464

FINITIONS
ACABADOS
FINISHES

Cf. page 464
Ver pagina 464
See page 464

	Indiv. / Individ. / Single					Indiv. / Individ. / Single			
	180 cm	356.054.---	356.154.---	356.254.---		180 cm	356.064.---	356.164.---	356.264.---
	160 cm	356.055.---	356.155.---	356.255.---		160 cm	356.065.---	356.165.---	356.265.---
	140 cm	356.056.---	356.156.---	356.256.---		140 cm	356.066.---	356.166.---	356.266.---
	Vis à vis / Enfrentadas / Face to face					Vis à vis / Enfrentadas / Face to face			
	180 cm	356.057.---	356.157.---	356.257.---		180 cm	356.067.---	356.167.---	356.267.---
	160 cm	356.058.---	356.158.---	356.258.---		160 cm	356.068.---	356.168.---	356.268.---
	140 cm	356.059.---	356.159.---	356.259.---		140 cm	356.069.---	356.169.---	356.269.---
	Méthacrylate Metacrilato Methacrylate					Avec méthacrylate et tissu Con metacrilato y tapizado With methacrylate and upholstered			

FINITIONS
ACABADOS
FINISHES

411

Transparente
Transparente
Clear

412

Blanc opaque
Translúcido
Translucent

FINITIONS
ACABADOS
FINISHES

406

Transparente
Transparente
Clear

427

Blanc opaque
Translúcido
Translucent

Cf. page 464
Ver pagina 464
See page 464

	Indiv. / Individ. / Single					Indiv. / Individ. / Single			
	180 cm	356.081.838	356.181.838	356.281.838		180 cm	356.083.838	356.183.838	356.283.838
	160 cm	356.083.838	356.183.838	356.283.838		160 cm	356.085.838	356.185.838	356.285.838
	140 cm	356.085.838	356.185.838	356.285.838		140 cm	356.091.838	356.191.838	356.291.838
	Vis à vis / Enfrentadas / Face to face					Vis à vis / Enfrentadas / Face to face			
	180 cm	356.091.838	356.191.838	356.291.838		180 cm	356.093.838	356.193.838	356.293.838
	160 cm	356.093.838	356.193.838	356.293.838		160 cm	356.095.838	356.195.838	356.295.838
	140 cm	356.095.838	356.195.838	356.295.838		140 cm	356.095.838	356.195.838	356.295.838
	Acoustique Acústico Acoustic								

FINITIONS
ACABADOS
FINISHES

Cf. page 464
Ver pagina 464
See page 464

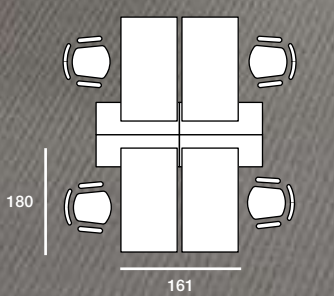

BORN

Un bureau au style nordique est possible avec la série BORN. Un design pratique et chaleureux qui répond à toutes les exigences pour créer des espaces calmes, ordonnés, propres et fonctionnels.

Una oficina con estilo nórdico es posible con la serie BORN. Un diseño práctico y cálido que reúne todos los requisitos para crear espacios tranquilos, ordenados, limpios y funcionales.





An office with Nordic style is possible with the BORN series. A practical and warm design due to the wooden legs and therefore able to create serene, neat, and useful spaces.

PLATEAU / SOBRE / DESKTOP

Mélamine / Melamina / Melamine: 25 mm
Stratifié / Estratificado / Stratified: 13 mm
10 mm

Chant en ABS / Canto ABS / ABS edges

STRUCTURE / ESTRUCTURA / FRAME

Bois: 60 x 60 mm - 60 x 30 mm 60 
Madera: 60 x 60 mm - 60 x 30 mm
Wood:
Acier: 50 x 30 x 2 mm 50 
Acero: 50 x 30 x 2 mm
Steel:
Mixte: 50 x 30 x 2 mm 50 
Mixta: 50 x 30 x 2 mm
Steel+Wood: 50 
30

FINITION STRUCTURE / ACABADO ESTRUCTURA / FRAME FINISH

Bois ou peinture époxy
Madera o pintura epoxi
Wood or epoxy paint

HAUTEUR / ALTURA / HEIGHT

73 cm

OPTION / OPCIÓN / OPTION

Voile de fond / Faldón / Modesty panel
Goulotte / Bandeja electrificación / Cable tray
Luminaires / Luminarias / Workstation lighting
Support écran / Soporte pantalla / Monitor holder
Cloisonnettes / Plafones / Screens

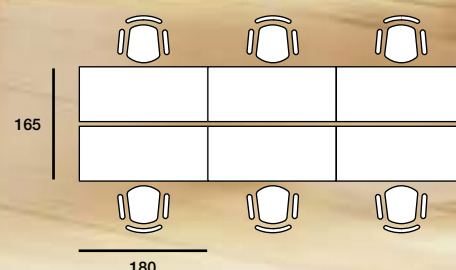

PIEDS
MÉTALLIQUES

LATERALES
METÁLICOS

METAL
FRAME

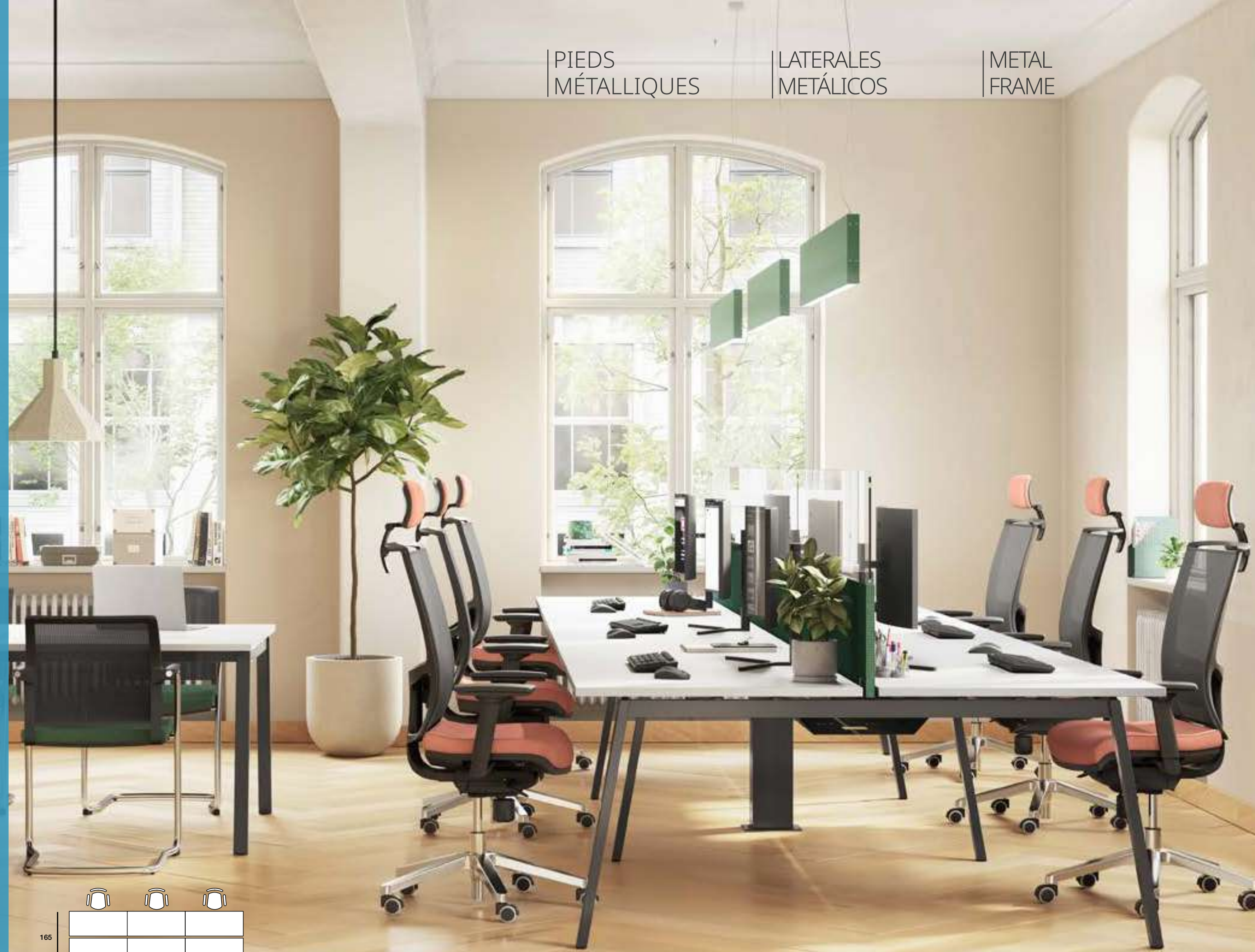



Luminaire pour tables en vis à vis.
Luminaria para mesas enfrentadas.
Workstation lighting for face to face desks.

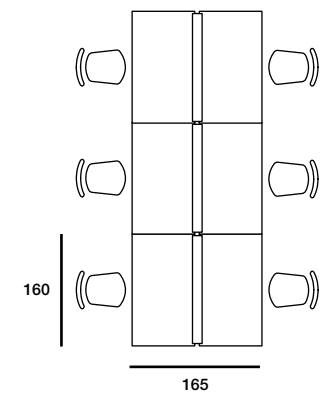

PIEDS
EN BOIS

LATERALES
DE MADERA

WOOD
FRAME

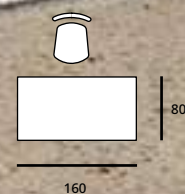

PIEDS
MÉTAL-BOIS

LATERAL
METAL-MADERA





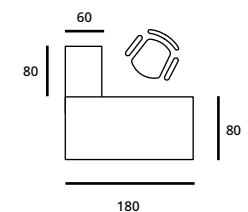



METAL-WOOD
FRAME

Un autre modèle de design pour la structure.
Un diseño alternativo para la estructura.
An alternative design for the frame.





MODÈLES | VARIANTES | VERSIONS

STRUCTURE MÉTALLIQUE ET MIXTE / ESTRUCTURA METAL I MIXTA / METAL FRAME AND METAL + WOOD FRAME

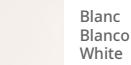

MODÈLE / VARIANTES / VERSIONS	TYPE / TIPO / TYPE	DIMENSIONS / MEDIDAS / MEASUREMENTS	RÉFÉRENCE / REFERENCIA / CODE
	Métallique / Metal / Metal	180 x 80 cm 160 x 80 cm 140 x 80 cm	631.102.-.- 631.103.-.- 631.104.-.-
	Mixte / Mixta / Metal + Wood	180 x 80 cm 160 x 80 cm 140 x 80 cm	631.602.-.- 631.603.-.- 631.604.-.-
Bureau individuel Mesa individual Individual desks			
	Métallique / Metal / Metal	360 x 165 cm 320 x 165 cm 280 x 165 cm 360 x 125 cm 320 x 125 cm 280 x 125 cm	631.120.-.- 631.121.-.- 631.122.-.- 631.168.-.- 631.169.-.- 631.170.-.-
	Mixte / Mixta / Metal + Wood	360 x 165 cm 320 x 165 cm 280 x 165 cm 360 x 125 cm 320 x 125 cm 280 x 125 cm	631.620.-.- 631.621.-.- 631.622.-.- 631.668.-.- 631.669.-.- 631.670.-.-
Bureaux en vis à vis Mesas enfrentadas Face to face desks			
	4 bureaux / mesas / desktops	360 x 165 cm 320 x 165 cm 280 x 165 cm 360 x 125 cm 320 x 125 cm 280 x 125 cm	631.220.-.- 631.221.-.- 631.222.-.- 631.268.-.- 631.269.-.- 631.270.-.-
	2 bureaux / mesas / desktops	180 x 165 cm 160 x 165 cm 140 x 165 cm 180 x 125 cm 160 x 125 cm 140 x 125 cm	631.128.-.- 631.129.-.- 631.130.-.- 631.176.-.- 631.177.-.- 631.178.-.-
	4 bureaux / mesas / desktops	360 x 165 cm 320 x 165 cm 280 x 165 cm 360 x 125 cm 320 x 125 cm 280 x 125 cm	631.720.-.- 631.721.-.- 631.722.-.- 631.768.-.- 631.769.-.- 631.770.-.-
	2 bureaux / mesas / desktops	180 x 165 cm 160 x 165 cm 140 x 165 cm 180 x 125 cm 160 x 125 cm 140 x 125 cm	631.628.-.- 631.629.-.- 631.630.-.- 631.676.-.- 631.677.-.- 631.678.-.-

FINITIONS | ACABADOS | FINISHES

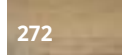
STRUCTURE / ESTRUCTURA / FRAME | PLATEAU / SOBRE / DESKTOP









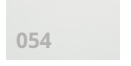

	Argent Plata Silver RAL 9006		Argent + Hêtre Plata + Haya Silver + Beech veneer		053 Blanc Blanco White		054 Gris Gris Grey		055 Hêtre Haya Beech
	Blanc Blanco White RAL 9016		Blanc + Hêtre Blanco + Haya White + Beech veneer		061 Chêne Moyen Roble Maple		062 Poirier Peral Pear		116 Wengué Wengue Wengue
	Graphite Grafito Graphite RAL 7022		Graphite + Hêtre Grafito + Haya Graphite + Beech veneer		103 Acacia Clair Acacia Clara Light Acacia		104 Acacia Foncé Acacia Oscura Dark Acacia		007 Graphite Grafito Graphite
					272 Chêne Veiné Castaño Claro Oak		273 Chêne Grisé Castaño Oscuro Dark Oak		

STRUCTURE EN BOIS / ESTRUCTURA MADERA / WOOD FRAME

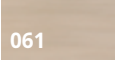

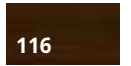
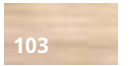

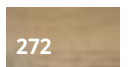

MODÈLE / VARIANTES / VERSIONS	TYPE / TIPO / TYPE	DIMENSIONS / MEDIDAS / MEASUREMENTS	RÉFÉRENCE / REFERENCIA / CODE
		180 x 80 cm 160 x 80 cm 140 x 80 cm	631.502.-.- 631.503.-.- 631.504.-.-
Bureau individuel Mesa individual Individual desks			
	4 bureaux / mesas / desktops	360 x 165 cm 320 x 165 cm 280 x 165 cm 360 x 125 cm 320 x 125 cm 280 x 125 cm	631.520.-.- 631.521.-.- 631.522.-.- 631.568.-.- 631.569.-.- 631.570.-.-
	2 bureaux / mesas / desktops	180 x 165 cm 160 x 165 cm 140 x 165 cm 180 x 125 cm 160 x 125 cm 140 x 125 cm	631.528.-.- 631.529.-.- 631.530.-.- 631.576.-.- 631.577.-.- 631.578.-.-
Bureaux en vis à vis Mesas enfrentadas Face to face desks			

FINITIONS | ACABADOS | FINISHES

STRUCTURE / ESTRUCTURA / FRAME | PLATEAU / SOBRE / DESKTOP

	Hêtre Haya Beech veneer		053 Blanc Blanco White		054 Gris Gris Grey		055 Hêtre Haya Beech		061 Chêne Moyen Roble Maple
	062 Poirier Peral Pear		116 Wengué Wengue Wengue		103 Acacia Clair Acacia Clara Light Acacia		104 Acacia Foncé Acacia Oscura Dark Acacia		
	007 Graphite Grafito Graphite		272 Chêne Veiné Castaño Claro Oak		273 Chêne Grisé Castaño Oscuro Dark Oak				

COMPLÉMENTS | COMPLEMENTOS | COMPLEMENTS







MODÈLE / VARIANTES / VERSIONS	DIMENSIONS / MEDIDAS / MEASUREMENTS	RÉFÉRENCE / REFERENCIA / CODE		
	120 x 60 cm 80 x 60 cm	631.191.-... 631.190.-...	631.291.-... 631.290.-...	631.391.-... 631.390.-...
	120 x 60 cm 80 x 60 cm	631.691.-... 631.690.-...	631.791.-... 631.790.-...	631.891.-... 631.890.-...
	120 x 60 cm 80 x 60 cm			631.591.-... 631.590.-...
Retour secrétaire Ala taquígrafa Return				
	80 x 40 cm	631.197.-...	631.297.-...	631.397.-...
Demi-rond Semicircular Semicircular				
	165 x 70 cm	631.198.-...	631.298.-...	631.398.-...
Demi-rond - Bureaux en vis à vis Semicircular - Mesas enfrentadas Semicircular - Face to face desks				
	165 x 40 cm	631.199.-...	631.299.-...	631.399.-...
Semi-elliptique - Bureaux en vis à vis Semielliptico - Mesas enfrentadas Semielliptic - Face to face desks				

FINITIONS | ACABADOS | FINISHES

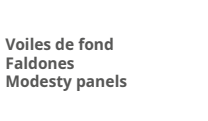
STRUCTURE / ESTRUCTURA / FRAME | PLATEAU / SOBRE / DESKTOP

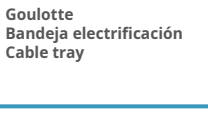
	Argent Plata Silver		Argent + Hêtre Plata + Haya Silver + Beech veneer		Hêtre Haya Beech veneer		053 Blanc Blanco White		054 Gris Gris Grey		055 Hêtre Haya Beech
	Blanc Blanco White		Blanc + Hêtre Blanco + Haya White + Beech veneer				061 Chêne Moyen Roble Maple		062 Poirier Peral Pear		116 Wengué Wengue Wengue
	Graphite Grafito Graphite		Graphite + Hêtre Grafito + Haya Graphite + Beech veneer				103 Acacia Clair Acacia Clara Light Acacia		104 Acacia Foncé Acacia Oscura Dark Acacia		007 Graphite Grafito Graphite
							272 Chêne Veiné Castaño Claro Oak		273 Chêne Gris Castaño Oscuro Dark Oak		

COMPLÉMENTS | COMPLEMENTOS | COMPLEMENTS

MODÈLE / VARIANTES / VERSIONS	TYPE / TIPO / TYPE	DIMENSIONS / MEDIDAS / MEASUREMENTS	RÉFÉRENCE / REFERENCIA / CODE		
	Mélamine / Melamina / Melamine	180 cm 160 cm 140 cm	1.351.706.051 1.351.708.051 1.351.710.051	1.351.706.053 1.351.708.053 1.351.710.053	1.351.706.007 1.351.708.007 1.351.710.007
Voiles de fond Faldones Modesty panels					
	Métal / Metal / Metal	180 cm 160 cm 140 cm	1.351.722.111 1.351.723.111 1.351.724.111	1.351.722.108 1.351.723.108 1.351.724.108	1.351.722.107 1.351.723.107 1.351.724.107
Voiles de fond Faldones Modesty panels					
	Pour bureaux / para mesas / for desks:	180 cm 160 cm 140 cm	1.356.302.111 1.356.303.111 1.356.304.111	1.356.302.108 1.356.303.108 1.356.304.108	1.356.302.107 1.356.303.107 1.356.304.107
Indiv. / Individ. / Single					
	Pour tables de réunion et bureaux en vis à vis / para mesas de reunión y enfrentadas / for meeting tables and face to face desks	250 / 200 cm 160 cm 150 / 140 cm 120 cm	1.636.312.111 1.636.313.111 1.636.314.111 1.636.315.111	1.636.312.108 1.636.313.108 1.636.314.108 1.636.315.108	1.636.312.301 1.636.313.301 1.636.314.301 1.636.315.301
Double / Doble / Double					
	Goulotte Bandeja electrificación Cable tray				
	Pour structure métallique et mixte / para estructura metal i mixta / for metal frame and metal + wood frame	180 cm 160 cm 140 cm	638.801.111 638.802.111 638.803.111	638.801.108 638.802.108 638.803.108	638.801.107 638.802.107 638.803.107
	Pour structure en bois / para estructura madera / for wood frame	180 cm 160 cm 140 cm	638.811.111 638.812.111 638.813.111	638.811.108 638.812.108 638.813.108	638.811.107 638.812.107 638.813.107
Luminaires pour tables en vis à vis Luminarias para mesas enfrentadas Workstation lighting					
	1 Rallonge connexion au mur / 1 latiguillo de conexión a pared / Fast cable connexion to wall socket	200 cm	446.991.000	446.992.000	446.995.000
Rallonge connexion Latiguillo de conexión Cable connexion					

FINITIONS | ACABADOS | FINISHES

STRUCTURE / ESTRUCTURA / FRAME

	Argent Plata Silver		Blanc Blanco White		Graphite Grafito Graphite
---------------------------------------------------------------------------------------	---------------------------	---------------------------------------------------------------------------------------	--------------------------	---------------------------------------------------------------------------------------	---------------------------------



| COMPLÉMENTS | COMPLEMENTOS | COMPLEMENTS

MODÈLE / VARIANTES / VERSIONS	TYPE / TIPO / TYPE	RÉFÉRENCE / REFERENCIA / CODE
	Individuel / Individual / Single	846.693.111  
	Double / Doble / Double	846.694.111  

Support écran
Soporte pantalla
Monitor holder

| FINITIONS | ACABADOS | FINISHES







STRUCTURE / ESTRUCTURA / FRAME

	Argent Plata Silver		Blanc Blanco White
RAL 9006		RAL 9016	

| CLOISONNETTES FRONTALES | PLAFONES | FRONT SCREENS

1 NIVEAU / 1 NIVEL / 1 LEVEL

2 NIVEAUX / 2 NIVELES / 2 LEVELS

MODÈLE / VARIANTES / VERSIONS	L.	RÉFÉRENCE / REFERENCIA / CODE	MODÈLE / VARIANTES / VERSIONS	L.	RÉFÉRENCE / REFERENCIA / CODE
		  			  
	180 cm	356.007.-... 356.107.-... 356.207.-...		180 cm	356.021.-... 356.121.-... 356.221.-...
	160 cm	356.008.-... 356.108.-... 356.208.-...		160 cm	356.022.-... 356.122.-... 356.222.-...
140 cm	356.009.-... 356.109.-... 356.209.-...	140 cm	356.023.-... 356.123.-... 356.223.-...		

Mélamine
Melamina
Melamine









FINITIONS ACABADOS FINISHES	007	Graphite Grafito Graphite	051	Argent Plata Silver	
053	Blanc Blanco White	054	Gris Gris Grey	055	Hêtre Haya Beech
061	Chêne Moyen Roble Maple	062	Poirier Peral Pear	116	Wengué Wengue Wengue
103	Acacia Clair Acacia Clara Light Acacia	104	Acacia Foncé Acacia Oscura Dark Acacia	272	Chêne Veiné Castaño Claro Oak
273	Chêne Gris Castaño Oscuro Dark Oak				

FINITIONS ACABADOS FINISHES	204	Graphite Grafito Graphite	088	Argent Plata Silver	
081	Blanc Blanco White	197	Gris Gris Grey	198	Hêtre Haya Beech
199	Chêne Moyen Roble Maple	200	Poirier Peral Pear	202	Wengué Wengue Wengue
103	Acacia Clair Acacia Clara Light Acacia	104	Acacia Foncé Acacia Oscura Dark Acacia	209	Chêne Veiné Castaño Claro Oak
235	Chêne Gris Castaño Oscuro Dark Oak				

| CLOISONNETTES FRONTALES | PLAFONES | FRONT SCREENS

1 NIVEAU / 1 NIVEL / 1 LEVEL





2 NIVEAUX / 2 NIVELES / 2 LEVELS

MODÈLE / VARIANTES / VERSIONS	L.	RÉFÉRENCE / REFERENCIA / CODE	MODÈLE / VARIANTES / VERSIONS	L.	RÉFÉRENCE / REFERENCIA / CODE
		  			  
	180 cm	356.007.000 356.107.000 356.207.000		180 cm	356.021.000 356.121.000 356.221.000
	160 cm	356.008.000 356.108.000 356.208.000		160 cm	356.022.000 356.122.000 356.222.000
140 cm	356.009.000 356.109.000 356.209.000	140 cm	356.023.000 356.123.000 356.223.000		

Tissu Tapizado Upholstered

FINITIONS ACABADOS FINISHES Cf. page 464 Ver pagina 464 See page 464

FINITIONS ACABADOS FINISHES Cf. page 464 Ver pagina 464 See page 464

MODÈLE / VARIANTES / VERSIONS	L.	RÉFÉRENCE / REFERENCIA / CODE
		  
	180 cm	356.007.-... 356.107.-... 356.207.-...
	160 cm	356.008.-... 356.108.-... 356.208.-...
140 cm	356.009.-... 356.109.-... 356.209.-...	

Méthacrylate Metacrilato Methacrylate

MODÈLE / VARIANTES / VERSIONS	L.	RÉFÉRENCE / REFERENCIA / CODE
		  
	180 cm	356.021.-... 356.121.-... 356.221.-...
	160 cm	356.022.-... 356.122.-... 356.222.-...
140 cm	356.023.-... 356.123.-... 356.223.-...	

Avec méthacrylate et tissu
Con metacrilato y tapizado
With methacrylate and upholstered

FINITIONS ACABADOS FINISHES 411 Transparent Transparente Clear 412 Blanc opaque Translúcido Translucent

FINITIONS ACABADOS FINISHES 406 Transparent Transparente Clear 427 Blanc opaque Translúcido Translucent Cf. page 464 Ver pagina 464 See page 464

tempo

Polyvalence et lignes épurées sont les principales caractéristiques de cette série. Elle nous permet de créer des espaces de travail avec une apparence légère et simple.

Versatilidad y simplicidad de formas son las características principales de esta serie. Se consiguen espacios diversos con formas ligeras y simples.

Versatility and simplicity on shapes are the main features of this range. Create different working spaces with light and simple looking.

PLATEAU / SOBRE / DESK TOP

Mélamine / Melamina / Melamine: 25 mm
Chant en ABS / Canto ABS / ABS edges

STRUCTURE / ESTRUCTURA / FRAME

Acier: 55 mm x 55 mm x 1,5 mm 
Steel: 55 mm x 55 mm x 1,5 mm

FINITION STRUCTURE / ACABADO ESTRUCTURA / FRAME FINISH

Peinture époxy
Pintura epoxi
Epoxy paint

HAUTEUR / ALTURA / HEIGHT

Fixe: 73 cm Réglable: 80,6 > 63 cm
Fija: 73 cm Regulable: 80,6 > 63 cm
Fixed: 73 cm Adjustable: 80,6 > 63 cm

OPTION / OPCIÓN / OPTION

Voile de fond / Faldón / Modesty panel
Goulotte / Bandeja electrificación / Cable tray
Cloisonnettes / Plafones / Screens

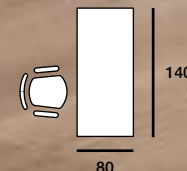

BUREAU
INDIVIDUEL

MESA
INDIVIDUAL

INDIVIDUAL
DESK



BUREAUX
EN VIS À VIS
AVEC CRÉDENCE

MESAS
ENFRENTADAS
CON CREDENCIA

FACE TO FACE
DESKS WITH
SIDE CREDENZA

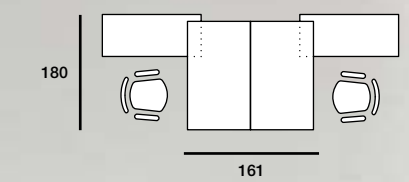

BUREAUX EN
VIS À VIS
AVEC RETOUR

MESAS
ENFRENTADAS
CON ALA

FACE TO
FACE DESKS
WITH RETURN

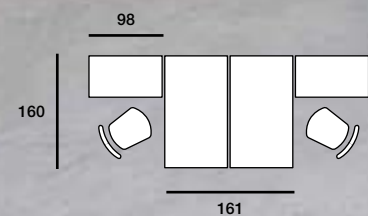

BUREAUX
EN VIS À VIS



MESAS
ENFRENTADAS

FACE TO
FACE DESKS

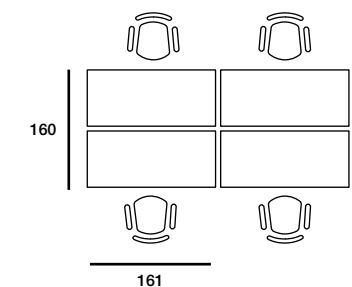



Combinable avec caissons et crédences OH-SYSTEMS.
Combinable con cajoneras y credencias OH-SYSTEMS.
Combine with OH-SYSTEMS pedestals and credenzas.



MODÈLES | VARIANTES | VERSIONS

MODÈLE / VARIANTES / VERSIONS	TYPE / TIPO / TYPE	DIMENSIONS / MEDIDAS / MEASUREMENTS	RÉFÉRENCE / REFERENCIA / CODE	
 <p>Bureau individuel Mesa individual Individual desks</p>		180 x 80 cm 160 x 80 cm 140 x 80 cm 120 x 80 cm 80 x 80 cm	H. fixe / fija / fixed	H. réglable / regulable / adjustable
			381.301.-.-	381.401.-.-
			381.302.-.-	381.402.-.-
			381.303.-.-	381.403.-.-
			381.304.-.-	381.404.-.-
		381.305.-.-	381.405.-.-	
 <p>Bureau individuel pour crédence Mesa individual con credencia Individual desks with side credenza</p>		180 x 80 cm 160 x 80 cm 140 x 80 cm	À droite / Derecha / Right	À gauche / Izquierda / Left
			381.381.-.-	381.382.-.-
			381.383.-.-	381.384.-.-
			381.385.-.-	381.386.-.-
 <p>Bureaux alignés Mesas lineales Side by side desks</p>		360 x 80 cm 320 x 80 cm 280 x 80 cm 240 x 80 cm	H. fixe / fija / fixed	H. réglable / regulable / adjustable
			381.318.-.-	381.418.-.-
			381.319.-.-	381.419.-.-
			381.320.-.-	381.420.-.-
			381.321.-.-	381.421.-.-
 <p>Bureaux en vis à vis Mesas enfrentadas Face to face desks</p>	4 bureaux / mesas / desktops	360 x 161 cm 320 x 161 cm 280 x 161 cm 240 x 161 cm	H. fixe / fija / fixed	H. réglable / regulable / adjustable
			381.362.-.-	381.462.-.-
			381.363.-.-	381.463.-.-
			381.364.-.-	381.464.-.-
			381.365.-.-	381.465.-.-
	2 bureaux / mesas / desktops	180 x 161 cm 160 x 161 cm 140 x 161 cm 120 x 161 cm		
			381.366.-.-	381.466.-.-
			381.367.-.-	381.467.-.-
			381.368.-.-	381.468.-.-
			381.369.-.-	381.469.-.-
 <p>Bureaux en vis à vis pour crédence Mesas enfrentadas con credencia Face to face desks with side credenza</p>	4 bureaux / mesas / desktops	360 x 161 cm 320 x 161 cm 280 x 161 cm	H. fixe / fija / fixed	
			381.388.-.-	
			381.389.-.-	
			381.390.-.-	
	2 bureaux / mesas / desktops	180 x 161 cm 160 x 161 cm 140 x 161 cm		
			381.391.-.-	

COMPLÉMENTS | COMPLEMENTOS | COMPLEMENTS



MODÈLE / VARIANTES / VERSIONS	DIMENSIONS / MEDIDAS / MEASUREMENTS	RÉFÉRENCE / REFERENCIA / CODE	
 <p>Retour secrétaire Ala taquígrafa Return</p>	120 x 98 cm 98 x 60 cm	H. fixe / fija / fixed	H. réglable / regulable / adjustable
		381.329.-.-	381.429.-.-
		381.328.-.-	381.428.-.-
 <p>Exécutif Ejecutivo Teardrop</p>	158 x 118 cm	H. fixe / fija / fixed	H. réglable / regulable / adjustable
		381.330.-.-	381.430.-.-
 <p>Demi-rond Semicircular Semircircular</p>	161 x 70 cm	H. fixe / fija / fixed	H. réglable / regulable / adjustable
		381.331.-.-	381.431.-.-
 <p>Semi-elliptique Semielíptico Semielliptic</p>	161 x 40 cm	H. fixe / fija / fixed	H. réglable / regulable / adjustable
		381.332.-.-	381.432.-.-
 <p>Angle concave 90° Ángulo cóncavo 90° 90° Concave angle</p>	123 X 78,3 cm	H. fixe / fija / fixed	
		1.381.033.-.-	

FINITIONS ACABADOS FINISHES



053	Blanc Blanco White	054	Gris Gris Grey	055	Hêtre Haya Beech	061	Chêne Moyen Roble Maple
062	Poirier Peral Pear	063	Wengué Wengue Wengue	103	Acacia Clair Acacia Clara Light Acacia	104	Acacia Foncé Acacia Oscura Dark Acacia
007	Graphite Grafito Graphite	272	Chêne Veiné Castaño Claro Oak	273	Chêne Grisé Castaño Oscuro Dark Oak		



FINITIONS | ACABADOS | FINISHES

STRUCTURE / ESTRUCTURA / FRAME | PLATEAU / SOBRE / DESK TOP

 <p>Argent Plata Silver</p> <p>RAL 9006</p>	060	Blanc Blanco White	064	Gris Gris Grey	065	Hêtre Haya Beech	066	Chêne Moyen Roble Maple	067	Poirier Peral Pear	068	Wengué Wengue Wengue
	706	Acacia Clair Acacia Clara Light Acacia	707	Acacia Foncé Acacia Oscura Dark Acacia	020	Graphite Grafito Graphite	031	Chêne Veiné Castaño Claro Oak	032	Chêne Grisé Castaño Oscuro Dark Oak		
 <p>Blanc Bianco White</p> <p>RAL 9016</p>	096	Blanc Blanco White	097	Gris Gris Grey	098	Hêtre Haya Beech	099	Chêne Moyen Roble Maple	100	Poirier Peral Pear	101	Wengué Wengue Wengue
	709	Acacia Clair Acacia Clara Light Acacia	710	Acacia Foncé Acacia Oscura Dark Acacia	017	Graphite Grafito Graphite	166	Chêne Veiné Castaño Claro Oak	167	Chêne Grisé Castaño Oscuro Dark Oak		
 <p>Graphite Grafito Graphite</p> <p>RAL 7022</p>	163	Blanc Blanco White	180	Gris Gris Grey	181	Hêtre Haya Beech	182	Chêne Moyen Roble Maple	183	Poirier Peral Pear	184	Wengué Wengue Wengue
	715	Acacia Clair Acacia Clara Light Acacia	716	Acacia Foncé Acacia Oscura Dark Acacia	113	Graphite Grafito Graphite	206	Chêne Veiné Castaño Claro Oak	208	Chêne Grisé Castaño Oscuro Dark Oak		

COMPLÉMENTS | COMPLEMENTOS | COMPLEMENTS



MODÈLE / VARIANTES / VERSIONS	DIMENSIONS / MEDIDAS / MEASUREMENTS	RÉFÉRENCE / REFERENCIA / CODE
	Mélamine / Melamina / Melamine 180 cm 160 cm 140 cm 120 cm Angle 90° / Ángulo 90° / 90° angle 80 cm	 441.602.051 441.602.053 441.602.007 441.603.051 441.603.053 441.603.007 441.604.051 441.604.053 441.604.007 441.605.051 441.605.053 441.605.007 441.618.051 441.618.053 441.618.007 441.606.051 441.606.053 441.606.007
Voiles de fond Faldones Modesty panels	Métal / Metal / Metal 180 cm 160 cm 140 cm 120 cm 80 cm	441.702.111 441.702.108 441.702.107 441.703.111 441.703.108 441.703.107 441.704.111 441.704.108 441.704.107 441.705.111 441.705.108 441.705.107 441.706.111 441.706.108 441.706.107

	Pour bureaux / para mesas / for desks: 220 cm 200 cm 180 cm 160 cm 140 cm 120 cm 80 cm	Individ. / Individ. / Single 1.386.300.111 1.386.300.108 1.386.300.107 1.386.301.111 1.386.301.108 1.386.301.107 1.386.302.111 1.386.302.108 1.386.302.107 1.386.303.111 1.386.303.108 1.386.303.107 1.386.304.111 1.386.304.108 1.386.304.107 1.386.305.111 1.386.305.108 1.386.305.107 1.386.307.111 1.386.307.108 1.386.307.107
	Pour tables de réunion et vis à vis / Para mesas de reunión y enfrentadas / For meeting tables and face to face desks 250 cm 200 cm 180 cm 150 / 160 cm 140 cm 120 cm 80 cm	Double / Doble / Double 1.386.310.111 1.386.310.108 1.386.310.107 1.386.311.111 1.386.311.108 1.386.311.107 1.386.312.111 1.386.312.108 1.386.312.107 1.386.313.111 1.386.313.108 1.386.313.107 1.386.314.111 1.386.314.108 1.386.314.107 1.386.315.111 1.386.315.108 1.386.315.107 1.386.317.111 1.386.317.108 1.386.317.107

Goulotte
Bandeja electrificación
Cable tray

FINITIONS | ACABADOS | FINISHES

STRUCTURE / ESTRUCTURA / FRAME

	Argent Plata Silver	RAL 9006
	Blanc Blanco White	RAL 9016
	Graphite Grafito Graphite	RAL 7022

CLOISONNETTES FRONTALES | PLAFONES | FRONT SCREENS

1 NIVEAU / 1 NIVEL / 1 LEVEL

MODÈLE / VARIANTES / VERSIONS	L	RÉFÉRENCE / REFERENCIA / CODE
		PINCES / PINZAS / BRACKET  RAL 9006 RAL 9016 RAL 7022 Individ. / Individ. / Single Vis à vis / Enfrentadas / Face to face 180 cm 386.008.--- 386.108.--- 386.208.--- 160 cm 386.009.--- 386.109.--- 386.209.--- 140 cm 386.010.--- 386.110.--- 386.210.--- 120 cm 386.011.--- 386.111.--- 386.211.--- 80 cm 386.013.--- 386.113.--- 386.213.---

Mélamine
Melamina
Melamine

FINITIONS ACABADOS FINISHES	007	Graphite Grafito Graphite	051	Argent Plata Silver	
053	Blanc Blanco White	054	Gris Gris Grey	055	Hêtre Haya Beech
061	Chêne Moyen Roble Maple	062	Poirier Peral Pear	116	Wengué Wengue Wengue
103	Acacia Clair Acacia Clara Light Acacia	104	Acacia Foncé Acacia Oscura Dark Acacia	272	Chêne Veiné Castaño Claro Oak
273	Chêne Gris Castaño Oscuro Dark Oak				

2 NIVEAUX / 2 NIVELES / 2 LEVELS

MODÈLE / VARIANTES / VERSIONS	L	RÉFÉRENCE / REFERENCIA / CODE
		PINCES / PINZAS / BRACKET  RAL 9006 RAL 9016 RAL 7022 Individ. / Individ. / Single Vis à vis / Enfrentadas / Face to face 180 cm 386.021.--- 386.121.--- 386.221.--- 160 cm 386.022.--- 386.122.--- 386.222.--- 140 cm 386.023.--- 386.123.--- 386.223.--- 120 cm 386.024.--- 386.124.--- 386.224.--- 80 cm 386.026.--- 386.126.--- 386.226.---

Mélamine
Melamina
Melamine

FINITIONS ACABADOS FINISHES	204	Graphite Grafito Graphite	088	Argent Plata Silver	
081	Blanc Blanco White	197	Gris Gris Grey	198	Hêtre Haya Beech
199	Chêne Moyen Roble Maple	200	Poirier Peral Pear	202	Wengué Wengue Wengue
103	Acacia Clair Acacia Clara Light Acacia	104	Acacia Foncé Acacia Oscura Dark Acacia	209	Chêne Veiné Castaño Claro Oak
235	Chêne Gris Castaño Oscuro Dark Oak				

	Individ. / Individ. / Single Vis à vis / Enfrentadas / Face to face 180 cm 386.008.000 386.108.000 386.208.000 160 cm 386.009.000 386.109.000 386.209.000 140 cm 386.010.000 386.110.000 386.210.000 120 cm 386.011.000 386.111.000 386.211.000 80 cm 386.013.000 386.113.000 386.213.000
---------------------------------------------------------------------------------------	-------------------------------------------------------------------------------------------------------------------------------------------------------------------------------------------------------------------------------------------------------------------------------------------------------------

Tissu Tapizado Upholstered

FINITIONS ACABADOS FINISHES Cf. page 464 Ver pagina 464 See page 464

	Individ. / Individ. / Single Vis à vis / Enfrentadas / Face to face 180 cm 386.021.000 386.121.000 386.221.000 160 cm 386.022.000 386.122.000 386.222.000 140 cm 386.023.000 386.123.000 386.223.000 120 cm 386.024.000 386.124.000 386.224.000 80 cm 386.026.000 386.126.000 386.226.000
---------------------------------------------------------------------------------------	-------------------------------------------------------------------------------------------------------------------------------------------------------------------------------------------------------------------------------------------------------------------------------------------------------------

Tissu Tapizado Upholstered

FINITIONS ACABADOS FINISHES Cf. page 464 Ver pagina 464 See page 464

	Individ. / Individ. / Single Vis à vis / Enfrentadas / Face to face 180 cm 386.008.--- 386.108.--- 386.208.--- 160 cm 386.009.--- 386.109.--- 386.209.--- 140 cm 386.010.--- 386.110.--- 386.210.--- 120 cm 386.011.--- 386.111.--- 386.211.--- 80 cm 386.013.--- 386.113.--- 386.213.---
---------------------------------------------------------------------------------------	-------------------------------------------------------------------------------------------------------------------------------------------------------------------------------------------------------------------------------------------------------------------------------------------------------------

Méthacrylate Metacrilato Methacrylate

FINITIONS ACABADOS FINISHES	411	Transparent Transparente Clear	412	Blanc opaque Translúcido Transparent
-----------------------------	-----	--------------------------------	-----	--------------------------------------

	Individ. / Individ. / Single Vis à vis / Enfrentadas / Face to face 180 cm 386.021.--- 386.121.--- 386.221.--- 160 cm 386.022.--- 386.122.--- 386.222.--- 140 cm 386.023.--- 386.123.--- 386.223.--- 120 cm 386.024.--- 386.124.--- 386.224.--- 80 cm 386.026.--- 386.126.--- 386.226.---
---------------------------------------------------------------------------------------	-------------------------------------------------------------------------------------------------------------------------------------------------------------------------------------------------------------------------------------------------------------------------------------------------------------

Avec méthacrylate et tissu Con metacrilato y tapizado With methacrylate and upholstered

FINITIONS ACABADOS FINISHES	406	Transparent Transparente Clear	427	Blanc opaque Translúcido Transparent	Cf. page 464 Ver pagina 464 See page 464
-----------------------------	-----	--------------------------------	-----	--------------------------------------	------------------------------------------

ECO

ECO, une série modulaire et polyvalente résolument adaptée aux besoins du marché.

Culminación de esfuerzos encaminados a satisfacer las necesidades de trabajo más exigentes.

This range is the result of many efforts seeking to meet the most demanding working needs from the simplicity of shapes and design.

PLATEAU / SOBRE / DESK TOP

Mélamine / Melamina / Melamine:
Stratifié / Estratificado / Stratified: 25 mm

Chant en ABS / Canto ABS / ABS edges

STRUCTURE / ESTRUCTURA / FRAME

Acier
Acero
Steel 60 x 60 x 2 mm



FINITION STRUCTURE / ACABADO ESTRUCTURA / FRAME FINISH

Peinture époxy
Pintura epoxi
Epoxy paint

HAUTEUR / ALTURA / HEIGHT

73 cm

OPTION / OPCIÓN / OPTION

Voile de fond / Faldón / Modesty panel
Goulotte / Bandeja electrificación / Cable tray
Cloisonnettes / Plafones / Screens



BUREAUX EN
VIS À VIS

MESAS
ENFRENTADAS

FACE TO FACE
DESKS

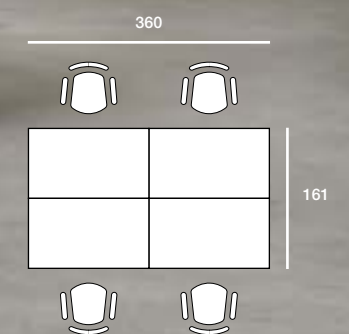



BUREAUX
INDIVIDUELS

MESAS
INDIVIDUALES

INDIVIDUAL
DESKS

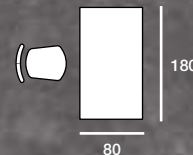

BUREAUX EN
VIS À VIS AVEC
CRÉDENCE

MESAS
ENFRENTADAS
CON CREDENCIA

FACE TO FACE
DESKS WITH
SIDE CREDENZA

Combinable avec caissons et crédences OH-SYSTEMS.
Combinable con cajoneras y credencias OH-SYSTEMS.
Combine with OH-SYSTEMS pedestals and credenzas.

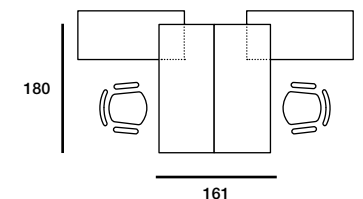





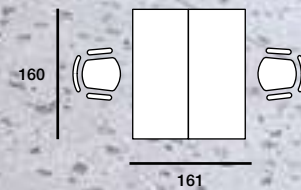

BUREAUX EN
VIS À VIS AVEC
ORGATOWER

MESAS
ENFRENTADAS
CON ORGATOWER





FACE TO FACE
DESKS WITH
ORGATOWER



MODÈLES | VARIANTES | VERSIONS

MODÈLE / VARIANTES / VERSIONS	TYPE / TIPO / TYPE	DIMENSIONS / MEDIDAS / MEASUREMENTS	RÉFÉRENCE / REFERENCIA / CODE
 <p>Bureau individuel Mesa individual Individual desks</p>		220 x 100 cm 200 x 100 cm	391.931.-.- 391.932.-.-
		180 x 80 cm 160 x 80 cm 140 x 80 cm 120 x 80 cm 80 x 80 cm	391.901.-.- 391.902.-.- 391.903.-.- 391.904.-.- 391.905.-.-
 <p>Bureau individuel pour crédence Mesa individual con credencia Individual desks with side credenza</p>		180 x 80 cm 160 x 80 cm 140 x 80 cm	391.906.-.- 391.908.-.- 391.910.-.-
			391.907.-.- 391.909.-.- 391.911.-.-
 <p>Bureaux en vis à vis Mesas enfrentadas Face to face desks</p>	4 bureaux / mesas / desktops	360 x 161 cm 320 x 161 cm 280 x 161 cm 200 x 161 cm	391.962.-.- 391.963.-.- 391.964.-.- 391.965.-.-
	2 bureaux / mesas / desktops	180 x 161 cm 160 x 161 cm 140 x 161 cm 100 x 161 cm	391.966.-.- 391.967.-.- 391.968.-.- 391.969.-.-
 <p>Bureaux en vis à vis pour crédence Mesas enfrentadas para credencia Face to face desks with side credenza</p>	4 bureaux / mesas / desktops	360 x 161 cm 320 x 161 cm 280 x 161 cm	391.934.-.- 391.935.-.- 391.936.-.-
	2 bureaux / mesas / desktops	180 x 161 cm 160 x 161 cm 140 x 161 cm	391.937.-.- 391.938.-.- 391.939.-.-

COMPLÉMENTS | COMPLEMENTOS | COMPLEMENTS

MODÈLE / VARIANTES / VERSIONS	DIMENSIONS / MEDIDAS / MEASUREMENTS	RÉFÉRENCE / REFERENCIA / CODE
 <p>Retour secrétaire Ala taquígrafa Return</p>	98 x 60 cm	Droite / Derecha / Right Gauche / Izquierda / Left 391.915.-.- 391.916.-.-
 <p>Exécutif Ejecutivo Teardrop</p>	158 x 118 cm	391.925.-.-
 <p>Demi-rond Semicircular Semicircular</p>	161 x 70 cm	391.019.-.-
 <p>Semi-elliptique Semielliptico Semielliptic</p>	161 x 40 cm	391.022.-.-
 <p>Angle concave 90° Ángulo cóncavo 90° 90° Concave angle</p>	123 X 78,3 cm	441.017.-.-

**FINITIONS
ACABADOS
FINISHES**

053 Blanc Blanco White	054 Gris Gris Grey	055 Hêtre Haya Beech	061 Chêne Moyen Roble Maple
062 Poirier Peral Pear	063 Wengué Wengue Wengue	103 Acacia Clair Acacia Clara Light Acacia	104 Acacia Foncé Acacia Oscura Dark Acacia
007 Graphite Grafito Graphite	272 Chêne Veiné Castaño Claro Oak	273 Chêne Grisé Castaño Oscuro Dark Oak	

FINITIONS | ACABADOS | FINISHES

STRUCTURE / ESTRUCTURA / FRAME | PLATEAU / SOBRE / DESK TOP

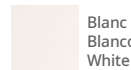
 <p>RAL 9006 Argent Plata Silver</p>	060 Blanc Blanco White	064 Gris Gris Grey	065 Hêtre Haya Beech	066 Chêne Moyen Roble Maple	067 Poirier Peral Pear
	068 Wengué Wengue Wengue	706 Acacia Clair Acacia Clara Light Acacia	707 Acacia Foncé Acacia Oscura Dark Acacia	020 Graphite Grafito Graphite	031 Chêne Veiné Castaño Claro Oak
	032 Chêne Grisé Castaño Oscuro Dark Oak				
 <p>Blanc Blanco White RAL 9016</p>	096 Blanc Blanco White	097 Gris Gris Grey	098 Hêtre Haya Beech	099 Chêne Moyen Roble Maple	100 Poirier Peral Pear
	101 Wengué Wengue Wengue	709 Acacia Clair Acacia Clara Light Acacia	710 Acacia Foncé Acacia Oscura Dark Acacia	017 Graphite Grafito Graphite	166 Chêne Veiné Castaño Claro Oak
	167 Chêne Grisé Castaño Oscuro Dark Oak				

COMPLÉMENTS | COMPLEMENTOS | COMPLEMENTS

MODÈLE / VARIANTES / VERSIONS	DIMENSIONS / MEDIDAS / MEASUREMENTS	RÉFÉRENCE / REFERENCIA / CODE		
 Voiles de fond Faldones Modesty panels	Mélamine / Melamina / Melamine	220 cm 200 cm 180 cm 160 cm 140 cm 120 cm Angle 90° / Ángulo 90° / 90° angle 80 cm	441.600.051 441.601.051 441.602.051 441.603.051 441.604.051 441.605.051 441.618.051 441.606.051	441.600.053 441.601.053 441.602.053 441.603.053 441.604.053 441.605.053 441.618.053 441.606.053
	Métal / Metal / Metal	220 cm 200 cm 180 cm 160 cm 140 cm 120 cm 80 cm	441.700.111 441.701.111 441.702.111 441.703.111 441.704.111 441.705.111 441.706.111	441.700.108 441.701.108 441.702.108 441.703.108 441.704.108 441.705.108 441.706.108

MODÈLE / VARIANTES / VERSIONS	DIMENSIONS / MEDIDAS / MEASUREMENTS	RÉFÉRENCE / REFERENCIA / CODE		
 Goulotte Bandeja electrificación Cable tray	Pour tables de réunion et bureaux en vis à vis / para mesas de reunión y enfrentadas / for meeting tables and face to face desks	250 cm 200 cm 180 cm 150 / 160 cm 140 cm 120 cm 80 cm	1.386.310.111 1.386.311.111 1.386.312.111 1.386.313.111	1.386.310.108 1.386.311.108 1.386.312.108 1.386.313.108
			1.386.314.111 1.386.315.111 1.386.317.111	1.386.314.108 1.386.315.108 1.386.317.108

FINITIONS | ACABADOS | FINISHES

STRUCTURE / ESTRUCTURA / FRAME

	Argent Plata Silver		Blanc Blanco White
RAL 9006		RAL 9016	

CLOISONNETTES FRONTALES | PLAFONES | FRONT SCREENS

1 NIVEAU / 1 NIVEL / 1 LEVEL

MODÈLE / VARIANTES / VERSIONS	L.	RÉFÉRENCE / REFERENCIA / CODE
 Mélamine Melamina Melamine	Indiv. / Indiv. / Single	
	Vis à vis / Enfrentadas / Face to face	
	180 cm	386.008.-.- 386.108.-.-
	160 cm	386.009.-.- 386.109.-.-
	140 cm	386.010.-.- 386.110.-.-
	120 cm	386.011.-.- 386.111.-.-
	80 cm	386.013.-.- 386.113.-.-

FINITIONS ACABADOS FINISHES	204	Graphite Grafito Graphite	088	Argent Plata Silver	
081	Blanc Blanco White	197	Gris Gris Grey	198	Hêtre Haya Beech
199	Chêne Moyen Roble Maple	200	Poirier Peral Pear	202	Wengué Wengue Wengue
103	Acacia Clair Acacia Clara Light Acacia	104	Acacia Foncé Acacia Oscura Dark Acacia	209	Chêne Veiné Castaño Claro Oak
235	Chêne Gris Castaño Oscuro Dark Oak				

2 NIVEAUX / 2 NIVELES / 2 LEVELS

MODÈLE / VARIANTES / VERSIONS	L.	RÉFÉRENCE / REFERENCIA / CODE
 Mélamine Melamina Melamine	Indiv. / Indiv. / Single	
	Vis à vis / Enfrentadas / Face to face	
	180 cm	386.021.-.- 386.121.-.-
	160 cm	386.022.-.- 386.122.-.-
	140 cm	386.023.-.- 386.123.-.-
	120 cm	386.024.-.- 386.124.-.-
	80 cm	386.026.-.- 386.126.-.-

FINITIONS ACABADOS FINISHES	204	Graphite Grafito Graphite	088	Argent Plata Silver	
081	Blanc Blanco White	197	Gris Gris Grey	198	Hêtre Haya Beech
199	Chêne Moyen Roble Maple	200	Poirier Peral Pear	202	Wengué Wengue Wengue
103	Acacia Clair Acacia Clara Light Acacia	104	Acacia Foncé Acacia Oscura Dark Acacia	209	Chêne Veiné Castaño Claro Oak
235	Chêne Gris Castaño Oscuro Dark Oak				

MODÈLE / VARIANTES / VERSIONS	L.	RÉFÉRENCE / REFERENCIA / CODE
 Tissu Tapizado Upholstered	Indiv. / Indiv. / Single	
	Vis à vis / Enfrentadas / Face to face	
	180 cm	386.008.000 386.108.000
	160 cm	386.009.000 386.109.000
	140 cm	386.010.000 386.110.000
	120 cm	386.011.000 386.111.000
	80 cm	386.013.000 386.113.000

FINITIONS ACABADOS FINISHES	Cf. page 464	Ver página 464	See page 464

MODÈLE / VARIANTES / VERSIONS	L.	RÉFÉRENCE / REFERENCIA / CODE
 Tissu Tapizado Upholstered	Indiv. / Indiv. / Single	
	Vis à vis / Enfrentadas / Face to face	
	180 cm	386.021.000 386.121.000
	160 cm	386.022.000 386.122.000
	140 cm	386.023.000 386.123.000
	120 cm	386.024.000 386.124.000
	80 cm	386.026.000 386.126.000

FINITIONS ACABADOS FINISHES	Cf. page 464	Ver página 464	See page 464

MODÈLE / VARIANTES / VERSIONS	L.	RÉFÉRENCE / REFERENCIA / CODE
 Méthacrylate Metacrilato Methacrylate	Indiv. / Indiv. / Single	
	Vis à vis / Enfrentadas / Face to face	
	180 cm	386.008.-.- 386.108.-.-
	160 cm	386.009.-.- 386.109.-.-
	140 cm	386.010.-.- 386.110.-.-
	120 cm	386.011.-.- 386.111.-.-
	80 cm	386.013.-.- 386.113.-.-

FINITIONS ACABADOS FINISHES	411	Transparent Transparente Clear	412	Blanc opaque Translúcido Translucent

MODÈLE / VARIANTES / VERSIONS	L.	RÉFÉRENCE / REFERENCIA / CODE
 Avec méthacrylate et tissu Con metacrilato y tapizado With methacrylate and upholstered	Indiv. / Indiv. / Single	
	Vis à vis / Enfrentadas / Face to face	
	180 cm	386.021.-.- 386.121.-.-
	160 cm	386.022.-.- 386.122.-.-
	140 cm	386.023.-.- 386.123.-.-
	120 cm	386.024.-.- 386.124.-.-
	80 cm	386.026.-.- 386.126.-.-

FINITIONS ACABADOS FINISHES	406	Transparent Transparente Clear	427	Blanc opaque Translúcido Translucent

OPÉRATIF
OPERATIVAS
INDIVIDUAL DESKS



108 | SIGMA



122 | TONO



134 | ROCK 3

sigma

SIGMA améliore votre poste de travail grâce à ses nouveaux concepts ergonomiques et esthétiques.

SIGMA mejora los puestos de trabajo aportándoles nuevos conceptos ergonómicos y estéticos.

SIGMA improves workplaces by its ergonomics features and design concepts.

PLATEAU / SOBRE / DESK TOP

Mélamine / Melamina / Melamine: 25 mm
Chant en ABS / Canto ABS / ABS edges

STRUCTURE / ESTRUCTURA / FRAME

Acier: 65 x 74 x 1,5 mm
Acero: 65 x 74 x 1,5 mm
Steel: 65 x 74 x 1,5 mm



* Montée de câbles intégrée / Subida de cables integrada / Cable management built-in frame

FINITION STRUCTURE / ACABADO ESTRUCTURA / FRAME FINISH

Peinture époxy
Pintura epoxi
Epoxy paint

HAUTEUR / ALTURA / HEIGHT

Fixe: 73 cm
Fija: 73 cm
Fixed: 73 cm
Réglable: 81,5> 63,5 cm
Regulable: 81,5> 63,5 cm
Adjustable: 81,5> 63,5 cm

OPTION / OPCIÓN / OPTION

Cloisonnettes / Plafones / Screens

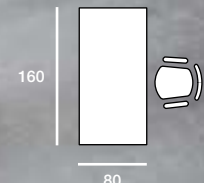

BUREAU
INDIVIDUEL

MESA
INDIVIDUAL

INDIVIDUAL
DESK

POSTE
COMPACT
SYMÉTRIQUE

PUESTO
COMPACTO
SIMÉTRICO

SYMMETRIC
L-SHAPED
DESK



Piédement métallique à dégagement latéral avec passage de câbles intégré.
Lateral en forma de "L" con pasa cables integrado.
L-shape frame with cable management cover.

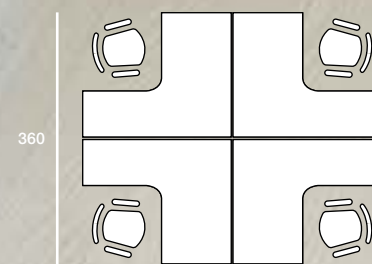



| POSTE
| COMPACT
| EXÉCUTIF

| PUESTO
| COMPACTO
| EJECUTIVO

| EXECUTIVE
| DESK

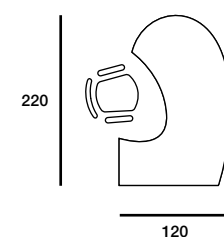



BANQUES
D'ACCUEIL

MOSTRADORES

COUNTERS FOR
TABLE TOPS

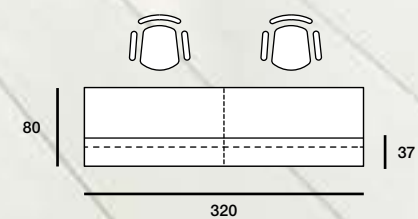

Rehausse d'accueil optionnelle.

Una opción fácil para resolver un puesto de atención al cliente.



An easy way to solve a customer service corner.

MODÈLES | VARIANTES | VERSIONS

MODÈLE / VARIANTES / VERSIONS	TYPE / TIPO / TYPE	DIMENSIONS / MEDIDAS / MEASUREMENTS	RÉFÉRENCE / REFERENCIA / CODE	
 Bureau individuel Mesa individual Rectangular desks	Coins droits / Cantos rectos / Square edges	180 x 80 cm 160 x 80 cm 140 x 80cm 120 x 80cm 80 x 80cm	231.102.-.- 231.103.-.- 231.104.-.- 231.105.-.- 231.107.-.-	
	Coins arrondis / Cantos redondos / Round edges	180 x 80 cm 160 x 80 cm 140 x 80cm 120 x 80cm 80 x 80cm	231.402.-.- 231.403.-.- 231.404.-.- 231.405.-.- 231.407.-.-	
Droit / Derecha / Right Gauche / Izquierda / Left				
 Bureau onde Mesa ola Wave shape desks	Coins droits / Cantos rectos / Square edges	180 x 100 - 80 cm 160 x 100 - 80 cm 140 x 100 - 80 cm	231.132.-.- 231.133.-.- 231.134.-.- 231.135.-.- 231.136.-.- 231.137.-.-	
	Coins arrondis / Cantos redondos / Round edges	180 x 100 - 80 cm 160 x 100 - 80 cm 140 x 100 - 80 cm	231.422.-.- 231.423.-.- 231.424.-.- 231.425.-.- 231.426.-.- 231.427.-.-	
Droit / Derecha / Right Gauche / Izquierda / Left				
 Poste compact exécutif Compacto ejecutivo Executive desks	Coins droits / Cantos rectos / Square edges	220 x 120 cm 200 x 120 cm	231.690.-.- 231.691.-.- 231.692.-.- 231.693.-.-	
			Droit / Derecha / Right Gauche / Izquierda / Left	
 Poste compact VII Compacto VII L-shaped desks VII	Coins droits / Cantos rectos / Square edges	L. 180 cm 180 x 160 cm 180 x 140 cm 180 x 120 cm	231.730.-.- 231.731.-.- 231.732.-.- 231.733.-.- 231.734.-.- 231.735.-.-	
	Coins arrondis / Cantos redondos / Round edges	L. 160 cm 160 x 160 cm 160 x 140 cm 160 x 120 cm	231.750.-.- 231.751.-.- 231.752.-.- 231.753.-.- 231.754.-.- 231.755.-.-	
 Poste compact VIII Compacto VIII L-shaped desks VIII	Coins droits / Cantos rectos / Square edges	160 x 160 cm 140 x 140 cm	231.712.-.- 231.714.-.-	
	Coins arrondis / Cantos redondos / Round edges	160 x 160 cm 140 x 140 cm	231.904.-.- 231.906.-.-	
 Poste compact symétrique Compacto simétrico L-shaped symmetrical desks	Coins droits / Cantos rectos / Square edges	180 x 180 cm 160 x 160 cm 140 x 140 cm	231.670.-.- 231.671.-.- 231.672.-.-	
	Coins arrondis / Cantos redondos / Round edges	180 x 180 cm 160 x 160 cm 140 x 140 cm	231.880.-.- 231.882.-.- 231.884.-.-	

FINITIONS | ACABADOS | FINISHES

STRUCTURE / ESTRUCTURA / FRAME | PLATEAU / SOBRE / DESK TOP

 Argent Plata Silver RAL 9006	060	Blanc Blanco White	064	Gris Gris Grey	065	Hêtre Haya Beech	066	Chêne Moyen Roble Maple	067	Poirier Peral Pear
	068	Wengué Wengue Wengue	706	Acacia Clair Acacia Clara Light Acacia	707	Acacia Foncé Acacia Oscura Dark Acacia	020	Graphite Grafito Graphite	031	Chêne Veiné Castaño Claro Oak
		032	Chêne Grisè Castaño Oscuro Dark Oak							
 Blanc Blanco White RAL 9016	096	Blanc Blanco White	097	Gris Gris Grey	098	Hêtre Haya Beech	099	Chêne Moyen Roble Maple	100	Poirier Peral Pear
	101	Wengué Wengue Wengue	709	Acacia Clair Acacia Clara Light Acacia	710	Acacia Foncé Acacia Oscura Dark Acacia	017	Graphite Grafito Graphite	166	Chêne Veiné Castaño Claro Oak
		167	Chêne Grisè Castaño Oscuro Dark Oak							
 Graphite Grafito Graphite RAL 7022	163	Blanc Blanco White	180	Gris Gris Grey	181	Hêtre Haya Beech	182	Chêne Moyen Roble Maple	183	Poirier Peral Pear
	184	Wengué Wengue Wengue	715	Acacia Clair Acacia Clara Light Acacia	716	Acacia Foncé Acacia Oscura Dark Acacia	113	Graphite Grafito Graphite	206	Chêne Veiné Castaño Claro Oak
		208	Chêne Grisè Castaño Oscuro Dark Oak							

COMPLÉMENTS | COMPLEMENTOS | COMPLEMENTS

MODÈLE / VARIANTES / VERSIONS	DIMENSIONS / MEDIDAS / MEASUREMENTS		RÉFÉRENCE / REFERENCIA / CODE	
	Coins droits / Cantos rectos / Square edges	98 X 60 cm	À droite / Derecha / Right 231.305.-.-	À gauche / Izquierda / Left 231.306.-.-
	Coins arrondis / Cantos redondos / Round edges	98 X 60 cm	231.309.-.-	231.310.-.-
	- Pour bureaux onde / Para mesas ola / For wave desks:			
	Coins droits / Cantos rectos / Square edges	82,8 X 60 cm	231.307.-.-	231.308.-.-
	Coins arrondis / Cantos redondos / Round edges	82,8 X 60 cm	231.311.-.-	231.312.-.-

Retour secrétaire
Ala taquígrafa
Return



Convivialité
Gota ejecutiva
Teardrop



Demi-rond
Semicircular
Semicircular

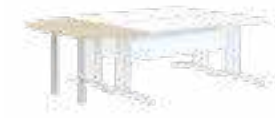

Demi-rond entre 2 bureaux
Semicircular para 2 mesas
Semicircular for two desks



Semi-elliptique
Semielliptico
Semielliptic



Angle concave 90°
Ángulo cóncavo 90°
90° Concave angle

FINITIONS ACABADOS FINISHES

053	Blanc Blanco White	054	Gris Gris Grey	055	Hêtre Haya Beech	061	Chêne Moyen Roble Maple
062	Poirier Peral Pear	063	Wengué Wengue Wengue	103	Acacia Clair Acacia Clara Light Acacia	104	Acacia Foncé Acacia Oscura Dark Acacia
007	Graphite Grafito Graphite	272	Chêne Veiné Castaño Claro Oak	273	Chêne Grisé Castaño Oscuro Dark Oak		

MODÈLE / VARIANTES / VERSIONS	DIMENSIONS / MEDIDAS / MEASUREMENTS	RÉFÉRENCE / REFERENCIA / CODE
	110 x 60 cm	231.304.-.-

Bureau secrétaire
Mesa taquígrafa
Shorthand desk



Banques d'accueil
Mostradores
Counters for table top

180 x 37 cm
160 x 37 cm
140 x 37 cm
120 x 37 cm
80 x 37 cm
117 x 47,3 cm (angle 90° / ángulo 90° / 90° angle)

1.233.004.-.-
1.233.006.-.-
1.233.008.-.-
1.233.010.-.-
1.233.012.-.-
1.233.020.-.-

FINITIONS ACABADOS FINISHES

053	Blanc Blanco White	054	Gris Gris Grey	055	Hêtre Haya Beech	061	Chêne Moyen Roble Maple
062	Poirier Peral Pear	063	Wengué Wengue Wengue	103	Acacia Clair Acacia Clara Light Acacia	104	Acacia Foncé Acacia Oscura Dark Acacia
007	Graphite Grafito Graphite	272	Chêne Veiné Castaño Claro Oak	273	Chêne Grisé Castaño Oscuro Dark Oak		

FINITIONS | ACABADOS | FINISHES

STRUCTURE / ESTRUCTURA / FRAME | PLATEAU / SOBRE / DESK TOP

Argent Plata Silver RAL 9006	060	Blanc Blanco White	064	Gris Gris Grey	065	Hêtre Haya Beech	066	Chêne Moyen Roble Maple	067	Poirier Peral Pear
	068	Wengué Wengue Wengue	706	Acacia Clair Acacia Clara Light Acacia	707	Acacia Foncé Acacia Oscura Dark Acacia	020	Graphite Grafito Graphite	031	Chêne Veiné Castaño Claro Oak
	032	Chêne Grisé Castaño Oscuro Dark Oak								
Blanc Blanco White RAL 9016	096	Blanc Blanco White	097	Gris Gris Grey	098	Hêtre Haya Beech	099	Chêne Moyen Roble Maple	100	Poirier Peral Pear
	101	Wengué Wengue Wengue	709	Acacia Clair Acacia Clara Light Acacia	710	Acacia Foncé Acacia Oscura Dark Acacia	017	Graphite Grafito Graphite	166	Chêne Veiné Castaño Claro Oak
	167	Chêne Grisé Castaño Oscuro Dark Oak								
Graphite Grafito Graphite RAL 7022	163	Blanc Blanco White	180	Gris Gris Grey	181	Hêtre Haya Beech	182	Chêne Moyen Roble Maple	183	Poirier Peral Pear
	184	Wengué Wengue Wengue	715	Acacia Clair Acacia Clara Light Acacia	716	Acacia Foncé Acacia Oscura Dark Acacia	113	Graphite Grafito Graphite	206	Chêne Veiné Castaño Claro Oak
	208	Chêne Grisé Castaño Oscuro Dark Oak								

CLOISONNETTES FRONTALES | PLAFONES | FRONT SCREENS

1 NIVEAU / 1 NIVEL / 1 LEVEL

2 NIVEAUX / 2 NIVELES / 2 LEVELS

MODÈLE / VARIANTES / VERSIONS	L.	RÉFÉRENCE / REFERENCIA / CODE
		<div style="display: flex; justify-content: space-around;"> <div style="text-align: center;">  RAL 9006 </div> <div style="text-align: center;">  RAL 9016 </div> <div style="text-align: center;">  RAL 7022 </div> </div>
		Indiv. / Indiv. / Single Vis à vis / Enfrentadas / Face to face
	180 cm	386.008.-... 386.108.-... 386.208.-...
	160 cm	386.009.-... 386.109.-... 386.209.-...
	140 cm	386.010.-... 386.110.-... 386.210.-...
	120 cm	386.011.-... 386.111.-... 386.211.-...
100 cm	386.012.-... 386.112.-... 386.212.-...	
80 cm	386.013.-... 386.113.-... 386.213.-...	

Mélamine
Melamina
Melamine

MODÈLE / VARIANTES / VERSIONS	L.	RÉFÉRENCE / REFERENCIA / CODE
		<div style="display: flex; justify-content: space-around;"> <div style="text-align: center;">  RAL 9006 </div> <div style="text-align: center;">  RAL 9016 </div> <div style="text-align: center;">  RAL 7022 </div> </div>
		Indiv. / Indiv. / Single Vis à vis / Enfrentadas / Face to face
	180 cm	386.021.-... 386.121.-... 386.221.-...
	160 cm	386.022.-... 386.122.-... 386.222.-...
	140 cm	386.023.-... 386.123.-... 386.223.-...
	120 cm	386.024.-... 386.124.-... 386.224.-...
100 cm	386.025.-... 386.125.-... 386.225.-...	
80 cm	386.026.-... 386.126.-... 386.226.-...	

Mélamine
Melamina
Melamine

FINITIONS ACABADOS FINISHES

007	Graphite Grafito Graphite	051	Argent Plata Silver
053	Blanc Blanco White	054	Gris Gris Grey
061	Chêne Moyen Roble Maple	062	Poirier Peral Pear
103	Acacia Clair Acacia Clara Light Acacia	104	Acacia Foncé Acacia Oscura Dark Acacia
116	Wengué Wengue Wengue	272	Chêne Veiné Castaño Claro Oak
273	Chêne Grisé Castaño Oscuro Dark Oak		

FINITIONS ACABADOS FINISHES

204	Graphite Grafito Graphite	088	Argent Plata Silver
081	Blanc Blanco White	197	Gris Gris Grey
199	Chêne Moyen Roble Maple	200	Poirier Peral Pear
103	Acacia Clair Acacia Clara Light Acacia	104	Acacia Foncé Acacia Oscura Dark Acacia
202	Wengué Wengue Wengue	209	Chêne Veiné Castaño Claro Oak
235	Chêne Grisé Castaño Oscuro Dark Oak		

MODÈLE / VARIANTES / VERSIONS	L.	RÉFÉRENCE / REFERENCIA / CODE
		Indiv. / Indiv. / Single Vis à vis / Enfrentadas / Face to face
	180 cm	386.008.000 386.108.000 386.208.000
	160 cm	386.009.000 386.109.000 386.209.000
	140 cm	386.010.000 386.110.000 386.210.000
	120 cm	386.011.000 386.111.000 386.211.000
	100 cm	386.012.000 386.112.000 386.212.000
80 cm	386.013.000 386.113.000 386.213.000	

Tissu
Tapizado
Upholstered

MODÈLE / VARIANTES / VERSIONS	L.	RÉFÉRENCE / REFERENCIA / CODE
		Indiv. / Indiv. / Single Vis à vis / Enfrentadas / Face to face
	180 cm	386.021.000 386.121.000 386.221.000
	160 cm	386.022.000 386.122.000 386.222.000
	140 cm	386.023.000 386.123.000 386.223.000
	120 cm	386.024.000 386.124.000 386.224.000
	100 cm	386.025.000 386.125.000 386.225.000
80 cm	386.026.000 386.126.000 386.226.000	

Tissu
Tapizado
Upholstered

FINITIONS ACABADOS FINISHES

Tapizado
Cf. page 464
Ver pagina 464
See page 464

FINITIONS ACABADOS FINISHES

Tapizado
Cf. page 464
Ver pagina 464
See page 464

MODÈLE / VARIANTES / VERSIONS	L.	RÉFÉRENCE / REFERENCIA / CODE
		Indiv. / Indiv. / Single Vis à vis / Enfrentadas / Face to face
	180 cm	386.008.-... 386.108.-... 386.208.-...
	160 cm	386.009.-... 386.109.-... 386.209.-...
	140 cm	386.010.-... 386.110.-... 386.210.-...
	120 cm	386.011.-... 386.111.-... 386.211.-...
	100 cm	386.012.-... 386.112.-... 386.212.-...
80 cm	386.013.-... 386.113.-... 386.213.-...	

Méthacrylate
Metacrilato
Methacrylate

MODÈLE / VARIANTES / VERSIONS	L.	RÉFÉRENCE / REFERENCIA / CODE
		Indiv. / Indiv. / Single Vis à vis / Enfrentadas / Face to face
	180 cm	386.021.-... 386.121.-... 386.221.-...
	160 cm	386.022.-... 386.122.-... 386.222.-...
	140 cm	386.023.-... 386.123.-... 386.223.-...
	120 cm	386.024.-... 386.124.-... 386.224.-...
	100 cm	386.025.-... 386.125.-... 386.225.-...
80 cm	386.026.-... 386.126.-... 386.226.-...	

Avec méthacrylate et tissu
Con metacrilato y tapizado
With methacrylate and upholstered

FINITIONS ACABADOS FINISHES

411	Transparent Transparente Clear	412	Blanc opaque Translúcido Translucent
------------	--------------------------------------	------------	--------------------------------------------

FINITIONS ACABADOS FINISHES

406	Transparent Transparente Clear	427	Blanc opaque Translúcido Translucent
------------	--------------------------------------	------------	--------------------------------------------

Tapizado
Cf. page 464
Ver pagina 464
See page 464

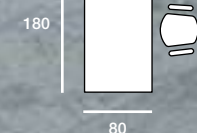

tono

Large éventail de styles et compositions avec un minimum de références.

Con esta serie se obtiene una gran versatilidad de estilos y composiciones con un número reducido de referencias.

Great variety of styles and compositions within the same range and easy to order.

PLATEAU / SOBRE / DESK TOP

Mélamine / Melamina / Melamine: 25 mm

Chant en ABS / Canto ABS / ABS edges

STRUCTURE / ESTRUCTURA / FRAME

Acier	6,5 cm	Mélamine	2,5 cm
Acero	75 cm	Melamina	67,5 cm
Steel		Melamine	

* Montée de câbles intégrée uniquement pour T2 / Subida de cables integrada para T2 / Cable management built-in frame for T2

STRUCTURE EN ACIER / ESTRUCTURA ACERO / STEEL FRAME

Peinture époxy
Pintura epoxi
Epoxy paint

HAUTEUR / ALTURA / HEIGHT

73 cm

OPTION / OPCIÓN / OPTION

Cloisonnettes / Plafones / Screens



BUREAU
INDIVIDUEL

MESA
INDIVIDUAL

INDIVIDUAL
DESK

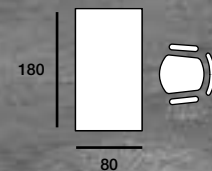

POSTE COMPACT
ÉXÉCUTIF

COMPACTO
EJECUTIVO

EXECUTIVE
DESK



POSTE
COMPACT

PUESTO
COMPACTO

L-SHAPED
DESKS



Passe-câbles extractible.
Perfil de subida de cables.
Cable beam.

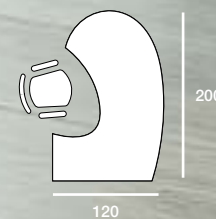
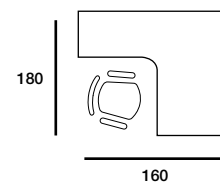

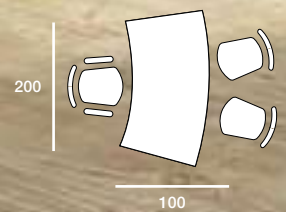

| BUREAU IV

| FORMA IV

| IV SHAPE

MODÈLES | VARIANTES | VERSIONS

T3

MODÈLE / VARIANTES / VERSIONS	DIMENSIONS / MEDIDAS / MEASUREMENTS	RÉFÉRENCE / REFERENCIA / CODE												
 <p>Bureau individuel IV Forma IV Shaped desk (IV)</p>	200 x 100 cm	601.107.-.-												
<p>FINITIONS ACABADOS FINISHES</p> <table border="0"> <tr> <td>053 Blanc Blanco White</td> <td>197 Gris Gris Grey</td> <td>198 Hêtre Haya Beech</td> <td>199 Chêne Moyen Roble Maple</td> </tr> <tr> <td>200 Poirier Peral Pear</td> <td>202 Wengué Wengue Wengue</td> <td>103 Acacia Clair Acacia Clara Light Acacia</td> <td>104 Acacia Foncé Acacia Oscura Dark Acacia</td> </tr> <tr> <td>007 Graphite Grafito Graphite</td> <td>209 Chêne Veiné Castaño Claro Oak</td> <td>235 Chêne Grisé Castaño Oscuro Dark Oak</td> <td></td> </tr> </table>			053 Blanc Blanco White	197 Gris Gris Grey	198 Hêtre Haya Beech	199 Chêne Moyen Roble Maple	200 Poirier Peral Pear	202 Wengué Wengue Wengue	103 Acacia Clair Acacia Clara Light Acacia	104 Acacia Foncé Acacia Oscura Dark Acacia	007 Graphite Grafito Graphite	209 Chêne Veiné Castaño Claro Oak	235 Chêne Grisé Castaño Oscuro Dark Oak	
053 Blanc Blanco White	197 Gris Gris Grey	198 Hêtre Haya Beech	199 Chêne Moyen Roble Maple											
200 Poirier Peral Pear	202 Wengué Wengue Wengue	103 Acacia Clair Acacia Clara Light Acacia	104 Acacia Foncé Acacia Oscura Dark Acacia											
007 Graphite Grafito Graphite	209 Chêne Veiné Castaño Claro Oak	235 Chêne Grisé Castaño Oscuro Dark Oak												
 <p>Bureau individuel Mesa individual Rectangular desks</p>	180 x 80 cm 160 x 80 cm 140 x 80 cm 120 x 80 cm 100 x 80 cm 80 x 80 cm	601.101.-.- 601.102.-.- 601.103.-.- 601.104.-.- 601.105.-.- 601.106.-.-												
 <p>Poste compact B Compacto B L-shape desk B</p>	180 x 120 cm 160 x 120 cm	Droit / Derecha / Right Gauche / Izquierda / Left 601.320.-.- 601.322.-.- 601.321.-.- 601.323.-.-												
 <p>Poste compact C Compacto C L-shape desk C</p>	180 x 160 cm 160 x 160 cm	Droit / Derecha / Right Gauche / Izquierda / Left 601.130.-.- 601.132.-.- 601.131.-.- 601.133.-.-												
 <p>Poste compact exécutif Compacto ejecutivo Executive desks</p>	200 x 120 cm	Droit / Derecha / Right Gauche / Izquierda / Left 601.342.-.- 601.343.-.-												

FINITIONS | ACABADOS | FINISHES

STRUCTURE / ESTRUCTURA / FRAME | PLATEAU / SOBRE / DESK TOP

T3 Piètements mélamine Lateral melamina Panel legs	075 Blanc Blanco White	054 Gris Gris Grey	055 Hêtre Haya Beech	061 Chêne Moyen Roble Maple	062 Poirier Peral Pear
Argent Plata Silver	116 Wengué Wengue Wengue	694 Acacia Clair Acacia Clara Light Acacia	695 Acacia Foncé Acacia Oscura Dark Acacia	115 Graphite Grafito Graphite	272 Chêne Veiné Castaño Claro Oak
Blanc Blanco White	273 Chêne Grisé Castaño Oscuro Dark Oak				

MODÈLES | VARIANTES | VERSIONS

T2

MODÈLE / VARIANTES / VERSIONS	DIMENSIONS / MEDIDAS / MEASUREMENTS	RÉFÉRENCE / REFERENCIA / CODE
 <p>Bureau individuel Mesa individual Rectangular desks</p>	180 x 80 cm 160 x 80 cm 140 x 80 cm 120 x 80 cm 100 x 80 cm 80 x 80 cm	601.201.-.- 601.202.-.- 601.203.-.- 601.204.-.- 601.205.-.- 601.206.-.-
 <p>Poste compact B Compacto B L-shaped desk B</p>	180 x 120 cm 160 x 120 cm	Droit / Derecha / Right Gauche / Izquierda / Left 601.420.-.- 601.422.-.- 601.421.-.- 601.423.-.-
 <p>Poste compact exécutif Compacto ejecutivo Executive desks</p>	200 x 120 cm	Droit / Derecha / Right Gauche / Izquierda / Left 601.442.-.- 601.443.-.-









FINITIONS | ACABADOS | FINISHES

STRUCTURE / ESTRUCTURA / FRAME | PLATEAU / SOBRE / DESK TOP





T2 Piètements en métal Lateral metálico T-shape frame	060 Blanc Blanco White	064 Gris Gris Grey	065 Hêtre Haya Beech	066 Chêne Moyen Roble Maple	067 Poirier Peral Pear
Argent Plata Silver RAL 9006	068 Wengué Wengue Wengue	706 Acacia Clair Acacia Clara Light Acacia	707 Acacia Foncé Acacia Oscura Dark Acacia	020 Graphite Grafito Graphite	031 Chêne Veiné Castaño Claro Oak
Blanc Blanco White RAL 9016	032 Chêne Grisé Castaño Oscuro Dark Oak				

| COMPLÉMENTS | COMPLEMENTOS | COMPLEMENTS

T3 / T2

MODÈLE / VARIANTES / VERSIONS	DIMENSIONS / MEDIDAS / MEASUREMENTS	RÉFÉRENCE / REFERENCIA / CODE
	100 x 60 cm 80 x 60 cm	601.251.-.- 601.252.-.-
Retour secrétaire Ala taquígrafa rectangular Return		
	100 x 60 cm 80 x 60 cm	À droite / Derecha / Right 601.260.-.- 601.262.-.-
Retour secrétaire avec forme Ala taquígrafa con forma Return with shape		À gauche / Izquierda / Left 601.261.-.- 601.263.-.-
	3 Tiroirs / Cajones / Drawers 100 x 60 cm 80 x 60 cm	601.253.-.- 601.254.-.-
Retour secrétaire avec caisson Ala taquígrafa con cajonera Return with fixed pedestal	1 Tiroir / Cajón / Drawer + 1 DS / Archivo / File 100 x 60 cm 80 x 60 cm	601.255.-.- 601.256.-.-
	3 Tiroirs / Cajones / Drawers 100 x 60 cm 80 x 60 cm	À droite / Derecha / Right 601.264.-.- 601.268.-.-
Retour secrétaire avec forme et caisson Ala taquígrafa con forma y cajonera Shape return with fixed pedestal	1 Tiroir / Cajón / Drawer + 1 DS / Archivo / File 100 x 60 cm 80 x 60 cm	À gauche / Izquierda / Left 601.265.-.- 601.269.-.-
	152 x 51,5 cm	À droite / Derecha / Right 601.280.-.-
Retour secrétaire pour bureau IV Ala taquígrafa para mesa IV Return for desk IV		À gauche / Izquierda / Left 601.281.-.-
	3 Tiroirs / Cajones / Drawers 152 x 51,5 cm	À Droite / Derecha / Right 601.282.-.-
Retour secrétaire pour bureau IV avec caisson Ala taquígrafa para mesa IV con cajonera Return for desk IV with fixed pedestal	1 Tiroir / Cajón / Drawer + 1 DS / Archivo / File 152 x 51,5 cm	À gauche / Izquierda / Left 601.283.-.-
	1 Tiroir / Cajón / Drawer + 1 DS / Archivo / File 152 x 51,5 cm	601.284.-.-
	80 x 40 cm	601.334.-.-
Demi-rond Semicircular Semicircular		

| COMPLÉMENTS | COMPLEMENTOS | COMPLEMENTS

MODÈLE / VARIANTES / VERSIONS	DIMENSIONS / MEDIDAS / MEASUREMENTS	RÉFÉRENCE / REFERENCIA / CODE																								
	161 x 40 cm	601.332.-.-																								
Demi-rond Semicircular Semicircular																										
	50,4 x 43,4 cm	601.333.-.-																								
Semi-elliptique Semiélliptico Semielliptic																										
	80 x 80 cm	1.601.030.-.-																								
Angle concave 90° Ángulo cóncavo 90° 90° Concave angle																										
	180 x 37 cm 160 x 37 cm 140 x 37 cm 120 x 37 cm 100 x 37 cm 80 x 37 cm	1.233.004.-.- 1.233.006.-.- 1.233.008.-.- 1.233.010.-.- 1.233.011.-.- 1.233.012.-.-																								
Banques d'accueil Mostradores Counters for table top	Angle concave / Ángulo cóncavo / Concave angle 107 x 37 cm	1.233.021.-.-																								
FINITIONS ACABADOS FINISHES	<table border="0"> <tr> <td>053</td><td>Blanc Blanco White</td> <td>054</td><td>Gris Gris Grey</td> <td>055</td><td>Hêtre Haya Beech</td> <td>061</td><td>Chêne Moyen Roble Maple</td> </tr> <tr> <td>062</td><td>Poirier Peral Pear</td> <td>063</td><td>Wengué Wengue Wengue</td> <td>103</td><td>Acacia Clair Acacia Clara Light Acacia</td> <td>104</td><td>Acacia Foncé Acacia Oscura Dark Acacia</td> </tr> <tr> <td>105</td><td>Zebrano Zebrano Zebrano</td> <td>007</td><td>Graphite Grafito Graphite</td> <td>272</td><td>Chêne Veiné Castaño Claro Oak</td> <td>273</td><td>Chêne Grisé Castaño Oscuro Dark Oak</td> </tr> </table>	053	Blanc Blanco White	054	Gris Gris Grey	055	Hêtre Haya Beech	061	Chêne Moyen Roble Maple	062	Poirier Peral Pear	063	Wengué Wengue Wengue	103	Acacia Clair Acacia Clara Light Acacia	104	Acacia Foncé Acacia Oscura Dark Acacia	105	Zebrano Zebrano Zebrano	007	Graphite Grafito Graphite	272	Chêne Veiné Castaño Claro Oak	273	Chêne Grisé Castaño Oscuro Dark Oak	
053	Blanc Blanco White	054	Gris Gris Grey	055	Hêtre Haya Beech	061	Chêne Moyen Roble Maple																			
062	Poirier Peral Pear	063	Wengué Wengue Wengue	103	Acacia Clair Acacia Clara Light Acacia	104	Acacia Foncé Acacia Oscura Dark Acacia																			
105	Zebrano Zebrano Zebrano	007	Graphite Grafito Graphite	272	Chêne Veiné Castaño Claro Oak	273	Chêne Grisé Castaño Oscuro Dark Oak																			
FINITIONS ACABADOS FINISHES	<table border="0"> <tr> <td>053</td><td>Blanc Blanco White</td> <td>054</td><td>Gris Gris Grey</td> <td>055</td><td>Hêtre Haya Beech</td> <td>061</td><td>Chêne Moyen Roble Maple</td> </tr> <tr> <td>062</td><td>Poirier Peral Pear</td> <td>063</td><td>Wengué Wengue Wengue</td> <td>103</td><td>Acacia Clair Acacia Clara Light Acacia</td> <td>104</td><td>Acacia Foncé Acacia Oscura Dark Acacia</td> </tr> <tr> <td>007</td><td>Graphite Grafito Graphite</td> <td>272</td><td>Chêne Veiné Castaño Claro Oak</td> <td>273</td><td>Chêne Grisé Castaño Oscuro Dark Oak</td> <td></td><td></td> </tr> </table>	053	Blanc Blanco White	054	Gris Gris Grey	055	Hêtre Haya Beech	061	Chêne Moyen Roble Maple	062	Poirier Peral Pear	063	Wengué Wengue Wengue	103	Acacia Clair Acacia Clara Light Acacia	104	Acacia Foncé Acacia Oscura Dark Acacia	007	Graphite Grafito Graphite	272	Chêne Veiné Castaño Claro Oak	273	Chêne Grisé Castaño Oscuro Dark Oak			
053	Blanc Blanco White	054	Gris Gris Grey	055	Hêtre Haya Beech	061	Chêne Moyen Roble Maple																			
062	Poirier Peral Pear	063	Wengué Wengue Wengue	103	Acacia Clair Acacia Clara Light Acacia	104	Acacia Foncé Acacia Oscura Dark Acacia																			
007	Graphite Grafito Graphite	272	Chêne Veiné Castaño Claro Oak	273	Chêne Grisé Castaño Oscuro Dark Oak																					

| FINITIONS | ACABADOS | FINISHES

STRUCTURE / ESTRUCTURA / FRAME | PLATEAU / SOBRE / DESK TOP

Piètements en métal Lateral metálico T-shape frame	060	Blanc Blanco White	064	Gris Gris Grey	065	Hêtre Haya Beech	066	Chêne Moyen Roble Maple	067	Poirier Peral Pear
Argent Plata Silver RAL 9006	068	Wengué Wengue Wengue	706	Acacia Clair Acacia Clara Light Acacia	707	Acacia Foncé Acacia Oscura Dark Acacia	020	Graphite Grafito Graphite	031	Chêne Veiné Castaño Claro Oak
Blanc Blanco White RAL 9016	032	Chêne Grisé Castaño Oscuro Dark Oak								

CLOISONNETTES FRONTALES | PLAFONES | FRONT SCREENS

1 NIVEAU / 1 NIVEL / 1 LEVEL

2 NIVEAUX / 2 NIVELES / 2 LEVELS

MODÈLE / VARIANTES / VERSIONS	L.	RÉFÉRENCE / REFERENCIA / CODE	MODÈLE / VARIANTES / VERSIONS	L.	RÉFÉRENCE / REFERENCIA / CODE
-------------------------------	----	-------------------------------	-------------------------------	----	-------------------------------

PINCES / PINZAS / BRACKET	RAL 9006		RAL 9016	

Indiv. / Indiv. / Single
Vis à vis / Enfrentadas / Face to face

180 cm	386.008.-..	386.108.-..
160 cm	386.009.-..	386.109.-..
140 cm	386.010.-..	386.110.-..
120 cm	386.011.-..	386.111.-..
80 cm	386.013.-..	386.113.-..

Mélamine
Melamina
Melamine

FINITIONS ACABADOS FINISHES		007		Graphite Grafito Graphite		051		Argent Plata Silver	
053	Blanc Blanco White	054	Gris Gris Grey	055	Hêtre Haya Beech	061	Chêne Moyen Roble Maple	062	Poirier Peral Pear
103	Acacia Clair Acacia Clara Light Acacia	104	Acacia Foncé Acacia Oscura Dark Acacia	272	Chêne Veiné Castaño Claro Oak	273	Chêne Gris Castaño Oscuro Dark Oak	116	Wengué Wengue Wengue

PINCES / PINZAS / BRACKET	RAL 9006		RAL 9016	

Indiv. / Indiv. / Single
Vis à vis / Enfrentadas / Face to face

180 cm	386.021.-..	386.121.-..
160 cm	386.022.-..	386.122.-..
140 cm	386.023.-..	386.123.-..
120 cm	386.024.-..	386.124.-..
80 cm	386.026.-..	386.126.-..

Mélamine
Melamina
Melamine

FINITIONS ACABADOS FINISHES		204		Graphite Grafito Graphite		088		Argent Plata Silver	
081	Blanc Blanco White	197	Gris Gris Grey	198	Hêtre Haya Beech	199	Chêne Moyen Roble Maple	200	Poirier Peral Pear
103	Acacia Clair Acacia Clara Light Acacia	104	Acacia Foncé Acacia Oscura Dark Acacia	209	Chêne Veiné Castaño Claro Oak	235	Chêne Gris Castaño Oscuro Dark Oak	202	Wengué Wengue Wengue

PINCES / PINZAS / BRACKET	RAL 9006		RAL 9016	

Indiv. / Indiv. / Single
Vis à vis / Enfrentadas / Face to face

180 cm	386.008.000	386.108.000
160 cm	386.009.000	386.109.000
140 cm	386.010.000	386.110.000
120 cm	386.011.000	386.111.000
80 cm	386.013.000	386.113.000

Tissu Tapizado Upholstered

FINITIONS ACABADOS FINISHES
Cf. page 464
Ver pagina 464
See page 464

PINCES / PINZAS / BRACKET	RAL 9006		RAL 9016	

Indiv. / Indiv. / Single
Vis à vis / Enfrentadas / Face to face

180 cm	386.021.000	386.121.000
160 cm	386.022.000	386.122.000
140 cm	386.023.000	386.123.000
120 cm	386.024.000	386.124.000
80 cm	386.026.000	386.126.000

Tissu Tapizado Upholstered

FINITIONS ACABADOS FINISHES
Cf. page 464
Ver pagina 464
See page 464

PINCES / PINZAS / BRACKET	RAL 9006		RAL 9016	

Indiv. / Indiv. / Single
Vis à vis / Enfrentadas / Face to face

180 cm	386.008.-..	386.108.-..
160 cm	386.009.-..	386.109.-..
140 cm	386.010.-..	386.110.-..
120 cm	386.011.-..	386.111.-..
80 cm	386.013.-..	386.113.-..

Méthacrylate Metacrilato Methacrylate

FINITIONS ACABADOS FINISHES
411 Transparente Clear
412 Blanc opaque Translúcido Transparent

PINCES / PINZAS / BRACKET	RAL 9006		RAL 9016	

Indiv. / Indiv. / Single
Vis à vis / Enfrentadas / Face to face

180 cm	386.021.-..	386.121.-..
160 cm	386.022.-..	386.122.-..
140 cm	386.023.-..	386.123.-..
120 cm	386.024.-..	386.124.-..
80 cm	386.026.-..	386.126.-..

Avec méthacrylate et tissu
Con metacrilato y tapizado
With methacrylate and upholstered

FINITIONS ACABADOS FINISHES
406 Transparente Clear
427 Blanc opaque Translúcido Transparent
Cf. page 464
Ver pagina 464
See page 464

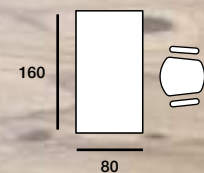

ROCK 3

La série ROCK 3 se caractérise par son pied panneau mélaminé. Elle vous permet de meubler votre bureau au meilleur prix possible, avec une grande gamme de finitions.

ROCK 3 se caracteriza por un lateral tipo panel. Permite amueblar las oficinas al mejor precio, con gran variedad de acabados.

ROCK 3 melamine panel legs range is an affordable, high quality and stylish furniture, enabling customers to furnish their office space within a specific budget,

PLATEAU / SOBRE / DESK TOP

Mélamine / Melamina / Melamine: 25 mm

Chant en ABS / Canto ABS / ABS edges

STRUCTURE / ESTRUCTURA / FRAME

Mélamine / Melamina / Melamine

25

HAUTEUR / ALTURA / HEIGHT

73 cm

OPTION / OPCIÓN / OPTION

Cloisonnettes / Plafones / Screens



BUREAU INDIVIDUEL
AVEC RETOUR

MESA INDIVIDUAL
CON ALA

INDIVIDUAL DESK
WITH RETURN

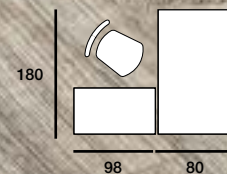



Entretroise en PVC.
Distanciador de plástico.
Plastic top spacers.

POSTES
COMPACTS
EN VIS À VIS

PUESTOS
COMPACTOS
ENFRENTADOS

L-SHAPE
FACE TO FACE
DESKS

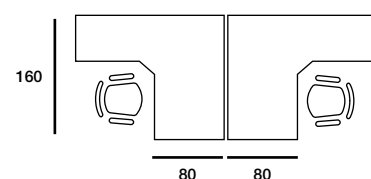

POSTE
COMPACT
ÉXÉCUTIF

PUESTO
COMPACTO
EJECUTIVO

EXECUTIVE
DESK



Design simple et élégant.
Un diseño simple y elegante.
A simple and smart design.

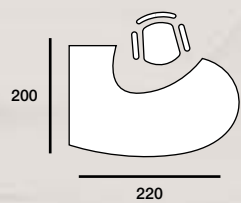

MODÈLES | VARIANTES | VERSIONS

MODÈLE / VARIANTES / VERSIONS	DIMENSIONS / MEDIDAS / MEASUREMENTS	RÉFÉRENCE / REFERENCIA / CODE
	180 x 80 cm 160 x 80 cm 140 x 80 cm 120 x 80 cm 80 x 80 cm	431.101... 431.102... 431.103... 431.104... 431.105...
Bureau rectangulaire Mesa individual Rectangular desks		

FINITIONS | ACABADOS | FINISHES

053	Blanc Blanco White	054	Gris Gris Grey	055	Hêtre Haya Beech	061	Chêne Moyen Roble Maple	062	Poirier Peral Pear
116	Wengué Wengue Wengue	103	Acacia Clair Acacia Clara Light Acacia	104	Acacia Foncé Acacia Oscura Dark Acacia	007	Graphite Grafito Graphite	272	Chêne Veiné Castaño Claro Oak
273	Chêne Grisé Castaño Oscuro Dark Oak								

MODÈLES | VARIANTES | VERSIONS

MODÈLE / VARIANTES / VERSIONS	DIMENSIONS / MEDIDAS / MEASUREMENTS	RÉFÉRENCE / REFERENCIA / CODE
	180 x 120 cm 160 x 120 cm	Droit / Derecha / Right 431.146... 431.160... Gauche / Izquierda / Left 431.147... 431.161...
Poste compact VII Compacto VII L-shaped desks VII		

	220 x 138 cm 200 x 138 cm	Droit / Derecha / Right 431.126... 431.128... Gauche / Izquierda / Left 431.127... 431.129...
Poste compact exécutif Compacto ejecutivo Executive desks		

FINITIONS | ACABADOS | FINISHES

060	Blanc Blanco White	064	Gris Gris Grey	065	Hêtre Haya Beech	066	Chêne Moyen Roble Maple	067	Poirier Peral Pear
068	Wengué Wengue Wengue	706	Acacia Clair Acacia Clara Light Acacia	707	Acacia Foncé Acacia Oscura Dark Acacia	020	Graphite Grafito Graphite	031	Chêne Veiné Castaño Claro Oak
032	Chêne Grisé Castaño Oscuro Dark Oak								

COMPLÉMENTS | COMPLEMENTOS | COMPLEMENTS

MODÈLE / VARIANTES / VERSIONS	DIMENSIONS / MEDIDAS / MEASUREMENTS	RÉFÉRENCE / REFERENCIA / CODE
	110 x 60 cm	431.114...
Bureau secrétaire Mesa taquígrafa Shorthand desk		

	98 x 60 cm	431.115...
Retour secrétaire Ala taquígrafa Return		

	123 X 78,3 cm	431.017...
Angle concave 90° Ángulo cóncavo 90° 90° concave angle		



FINITIONS ACABADOS FINISHES

053	Blanc Blanco White	054	Gris Gris Grey	055	Hêtre Haya Beech
061	Chêne Moyen Roble Maple	062	Poirier Peral Pear	116	Wengué Wengue Wengue
103	Acacia Clair Acacia Clara Light Acacia	104	Acacia Foncé Acacia Oscura Dark Acacia	007	Graphite Grafito Graphite
272	Chêne Veiné Castaño Claro Oak	273	Chêne Grisé Castaño Oscuro Dark Oak		

FINITIONS | ACABADOS | FINISHES

053	Blanc Blanco White	054	Gris Gris Grey	055	Hêtre Haya Beech	061	Chêne Moyen Roble Maple	062	Poirier Peral Pear
063	Wengué Wengue Wengue	103	Acacia Clair Acacia Clara Light Acacia	104	Acacia Foncé Acacia Oscura Dark Acacia	007	Graphite Grafito Graphite	272	Chêne Veiné Castaño Claro Oak
273	Chêne Grisé Castaño Oscuro Dark Oak								

| COMPLÉMENTS | COMPLEMENTOS | COMPLEMENTS

MODÈLE / VARIANTES / VERSIONS	DIMENSIONS / MEDIDAS / MEASUREMENTS	RÉFÉRENCE / REFERENCIA / CODE
	160 x 70 cm	431.119.---
Demi-rond Semicircular Semicircular		
	160 x 40 cm	431.122.---
Semi-elliptique Semielliptico Semielliptic		

| FINITIONS | ACABADOS | FINISHES

060	Blanc Blanco White	064	Gris Gris Grey	065	Hêtre Haya Beech	066	Chêne Moyen Roble Maple	067	Poirier Peral Pear
068	Wengué Wengue Wengue	706	Acacia Clair Acacia Clara Light Acacia	707	Acacia Foncé Acacia Oscura Dark Acacia	020	Graphite Grafito Graphite	031	Chêne Veiné Castaño Claro Oak
032	Chêne Grisé Castaño Oscuro Dark Oak								

| CLOISONNETTES FRONTALES | PLAFONES | FRONT SCREENS

1 NIVEAU / 1 NIVEL / 1 LEVEL

MODÈLE / VARIANTES / VERSIONS	L	RÉFÉRENCE / REFERENCIA / CODE							
	Indiv. / Indiv. / Single								
	180 cm	406.004.---							
	160 cm	406.006.---							
	140 cm	406.008.---							
	120 cm	406.010.---							
	80 cm	406.014.---							
Mélamine Melamina Melamine									
FINITIONS ACABADOS FINISHES									
051	Argent Plata Silver	053	Blanc Blanco White	054	Gris Gris Grey	055	Hêtre Haya Beech	061	Chêne Moyen Roble Maple
062	Poirier Peral Pear	063	Wengué Wengue Wengue	103	Acacia Clair Acacia Clara Light Acacia	104	Acacia Foncé Acacia Oscura Dark Acacia	007	Graphite Grafito Graphite
272	Chêne Veiné Castaño Claro Oak	273	Chêne Grisé Castaño Oscuro Dark Oak						



DIRECTION
DIRECCIÓN
EXECUTIVE DESKS



146 | TAK



156 | OPEN

TAK

C'est une série de direction aux lignes droites et élégantes qui s'éloigne de tout ce qui est prétentieux.

Es una serie direccional que se armoniza para crear un sitio de trabajo funcional y práctico, de líneas rectas y puras en todo su conjunto.

TAK is a solid, straight lined and at the same time elegant looking executive range.

PLATEAU / SOBRE / DESK TOP

Mélamine / Melamina / Melamine: 40 mm

Chant en ABS / Canto ABS / ABS edges

STRUCTURE / ESTRUCTURA / FRAME

Mélamine / Melamina / Melamine:

40

FINITION STRUCTURE / ACABADO ESTRUCTURA / FRAME FINISH

Mélamine ou bois vernis
Melamina o madera barnizada
Melamine or wood veneer

HAUTEUR / ALTURA / HEIGHT

73 cm

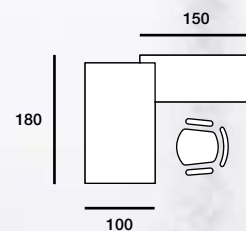

BUREAU DE
DIRECTION
AVEC CRÉDENCE

MESA DE
DIRECCIÓN
CON CREDENCIA

EXECUTIVE
DESK WITH
SIDE CREDENZA



BUREAU DE
DIRECTION
AVEC RETOUR

MESA DE
DIRECCIÓN
CON ALA

EXECUTIVE
DESK WITH
RETURN



Entretoises et patins, finition chromée.
Distanciadores acabados en cromado.
Chrome top spacers.

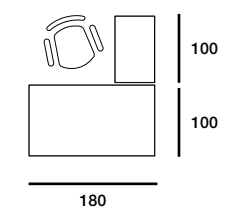



BUREAU DE
DIRECTION

MESA DE
DIRECCIÓN

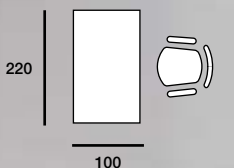
EXECUTIVE
DESK



MODÈLES | VARIANTES | VERSIONS

MODÈLE / VARIANTES / VERSIONS	DIMENSIONS / MEDIDAS / MEASUREMENTS	RÉFÉRENCE / REFERENCIA / CODE	
 <p>Bureau de direction Mesa de dirección Executive desk</p>	220 x 100 cm 200 x 100 cm 180 x 100 cm 160 x 100 cm	Mélamine Melamina Melamine	Noyer Américain Nogal Americano American Walnut
	180 x 80 cm 160 x 80 cm 140 x 80 cm	561.100.-.- 561.101.-.- 561.102.-.- 561.103.-.-	561.400.365 561.401.365 561.402.365 561.403.365
		561.105.-.- 561.106.-.- 561.107.-.-	
 <p>Bureau de direction pour crédence fixe Mesa de dirección con credencia Executive desk with side credenza</p>	À droite / Derecha / Right 220 x 100 cm 200 x 100 cm 180 x 100 cm 160 x 100 cm	Mélamine Melamina Melamine	Noyer Américain Nogal Americano American Walnut
	À gauche / Izquierda / Left 220 x 100 cm 200 x 100 cm 180 x 100 cm 160 x 100 cm	561.150.-.- 561.152.-.- 561.154.-.- 561.156.-.-	561.450.365 561.452.365 561.454.365 561.456.365
		561.151.-.- 561.153.-.- 561.155.-.- 561.157.-.-	561.451.365 561.453.365 561.455.365 561.457.365

FINITIONS | ACABADOS | FINISHES

Monochrome Monocolor Single-colour	053	Blanc Blanco White	103	Acacia Clair Acacia Clara Light Acacia	104	Acacia Foncé Acacia Oscura Dark Acacia	272	Chêne Veiné Castaño Claro Oak
	273	Chêne Grisé Castaño Oscuro Dark Oak		Noyer Américain Nogal Americano American Walnut				

COMPLÉMENTS | COMPLEMENTOS | COMPLEMENTS

MODÈLE / VARIANTES / VERSIONS	TYPE / TIPO / TYPE	DIMENSIONS / MEDIDAS / MEASUREMENTS	RÉFÉRENCE / REFERENCIA / CODE		
 <p>Retour secrétaire Ala taquígrafa Return</p>	Pour bureaux P.100 / para mesas P.100 / for desks D.100	100 x 60 cm 80 x 60 cm	Mélamine Melamina Melamine	Noyer Américain Nogal Americano American Walnut	
	Pour bureaux P.80 / para mesas P.80 / for desks D.80	100 x 60 cm 80 x 60 cm	561.110.-.- 561.111.-.-	561.410.365 561.411.365	
 <p>Crédence à roulettes Credencia con ruedas Side credenza with wheels</p>	À droite / Derecha / Right	Prof./ Depth. 57 cm L. 115 H. 58,5 cm L. 87 H. 58,5 cm L. 72 H. 58,5 cm	3 Tiroirs / Cajones / Drawers	342.410.-.- 342.414.-.- 342.418.-.-	342.810.365 342.814.365 342.818.365
	À gauche / Izquierda / Left	L. 115 H. 58,5 cm L. 87 H. 58,5 cm L. 72 H. 58,5 cm	1 Tiroir / Cajón / Drawer + 1 DS / Archivo / File	342.412.-.- 342.416.-.- 342.420.-.-	342.812.365 342.816.365 342.820.365
		Prof./ Depth. 57 cm L. 115 H. 58,5 cm L. 87 H. 58,5 cm L. 72 H. 58,5 cm	3 Tiroirs / Cajones / Drawers	342.411.-.- 342.415.-.- 342.419.-.-	342.811.365 342.815.365 342.819.365
		L. 115 H. 58,5 cm L. 87 H. 58,5 cm L. 72 H. 58,5 cm	1 Tiroir / Cajón / Drawer + 1 DS / Archivo / File	342.413.-.- 342.417.-.- 342.421.-.-	342.813.365 342.817.365 342.821.365

COMPLÉMENTS | COMPLEMENTOS | COMPLEMENTS

MODÈLE / VARIANTES / VERSIONS	TYPE / TIPO / TYPE	DIMENSIONS / MEDIDAS / MEASUREMENTS	RÉFÉRENCE / REFERENCIA / CODE	
 <p>Crédence fixe avec portes coulissantes Credencia con puertas correderas Side credenza with sliding doors</p>	À droite / Derecha / Right	Prof./ Depth. 54,2 cm L. 200 H. 56,2 cm L. 150 H. 56,2 cm	Mélamine Melamina Melamine	Noyer Américain Nogal Americano American Walnut
	À gauche / Izquierda / Left	L. 200 H. 56,2 cm L. 150 H. 56,2 cm	562.101.-.- 562.102.-.- 562.105.-.- 562.106.-.-	562.401.365 562.402.365 562.405.365 562.406.365
	À droite / Derecha / Right	L. 200 H. 56,2 cm L. 150 H. 56,2 cm	562.103.-.- 562.107.-.-	562.403.365 562.407.365
	À gauche / Izquierda / Left	L. 200 H. 56,2 cm L. 150 H. 56,2 cm	562.104.-.- 562.108.-.-	562.404.365 562.408.365
 <p>Caisson à roulettes Cajonera con ruedas Mobile pedestal</p>	3 Tiroirs / Cajones / Drawers	57 x 44 H. 55,5 cm	Mélamine Melamina Melamine	Noyer Américain Nogal Americano American Walnut
	1 Tiroir / Cajón / Drawer + 1 DS / Archivo / File	57 x 44 H. 55,5 cm	342.400.-.- 342.401.-.-	342.800.365 342.801.365

FINITIONS | ACABADOS | FINISHES

Monochrome Monocolor Single-colour	053	Blanc Blanco White	103	Acacia Clair Acacia Clara Light Acacia	104	Acacia Foncé Acacia Oscura Dark Acacia	272	Chêne Veiné Castaño Claro Oak
	273	Chêne Grisé Castaño Oscuro Dark Oak		Noyer Américain Nogal Americano American Walnut				

COMPLÉMENTS | COMPLEMENTOS | COMPLEMENTS

MODÈLE / VARIANTES / VERSIONS	TYPE / TIPO / TYPE	DIMENSIONS / MEDIDAS / MEASUREMENTS	RÉFÉRENCE / REFERENCIA / CODE		
 <p>Goulotte Bandeja electrificación Cable tray</p>	Pour bureaux / para mesas / for desks:	220 cm 200 cm 180 cm 160 cm	Indiv. / Indiv. / Single		
			1.566.001.111 1.566.002.111 1.566.003.111 1.566.004.111	1.566.001.108 1.566.002.108 1.566.003.108 1.566.004.108	1.566.001.107 1.566.002.107 1.566.003.107 1.566.004.107

FINITIONS | ACABADOS | FINISHES

RAL 9006	Argent Plata Silver	RAL 9016	Blanc Blanco White	RAL 7022	Graphite Grafito Graphite
----------	---------------------------	----------	--------------------------	----------	---------------------------------

| COMPLÉMENTS | COMPLEMENTOS | COMPLEMENTS

MODÈLE / VARIANTES / VERSIONS	RÉFÉRENCE / REFERENCIA / CODE
 <p>Sous-main Vade Leather pad</p>	<p>561.001.000</p>  <p>Cf. page 464 - Série 7 Ver pagina 464 - Serie 7 See page 464 - Serie 7</p>

| MODÈLES | VARIANTES | VERSIONS

ARMOIRES / ARMARIOS / CABINETS

ÉTAGÈRES INCLUSES / ESTANTES INCLUIDOS / INCLUDED SHELVES

MODÈLE / VARIANTES / VERSIONS	TYPE / TIPO / TYPE	DIMENSIONS / MEDIDAS / MEASUREMENTS	RÉFÉRENCE / REFERENCIA / CODE	
 <p>Armoire ouverte avec étagères Armario con estantes Cabinet shelves</p>	Prof./ Depth. 42 cm	L. 100 H. 201,4 cm L. 100 H. 147 cm L. 100 H. 76,6 cm	<p>Mélamine Melamina Melamina</p> <p>Noyer Américain Nogal Americano American Walnut</p>	<p>345.504.-.- 345.502.-.- 345.506.-.-</p> <p>345.704.365 345.702.365 345.706.365</p>

 <p>Armoire portes en mélamine Armario con puertas de melamina Cabinet with doors</p>	Prof./ Depth. 42 cm	L. 100 H. 201,4 cm L. 100 H. 147 cm L. 100 H. 76,6 cm	<p>345.505.-.- 345.503.-.- 345.507.-.-</p> <p>345.705.365 345.703.365 345.707.365</p>
----------------------------------------------------------------------------------------------------------------------------------------------------------------------------------	---------------------	-------------------------------------------------------------	-------------------------------------------------------------------------------------------------------

 <p>Armoire avec DS Armario con archivos Files cabinet</p>	Prof./ Depth. 42 cm	L. 100 H. 76,6 cm	<p>345.512.-.-</p> <p>345.712.365</p>
-------------------------------------------------------------------------------------------------------------------------------------------------------	---------------------	-------------------	---------------------------------------

| FINITIONS | ACABADOS | FINISHES

Monochrome Monocolor Single-colour	<p>053 Blanc Blanco White</p> <p>103 Acacia Clair Acacia Clara Light Acacia</p> <p>104 Acacia Foncé Acacia Oscura Dark Acacia</p> <p>272 Chêne Veiné Castaño Claro Oak</p>	<p>273 Chêne Grisé Castaño Oscuro Dark Oak</p> <p>Noyer Américain Nogal Americano American Walnut</p>
------------------------------------------	------------------------------------------------------------------------------------------------------------------------------------------------------------------------------------------------------------	-----------------------------------------------------------------------------------------------------------------------

| MODÈLES | VARIANTES | VERSIONS

ARMOIRES PORTES EN VERRE / ARMARIOS PUERTAS VIDRIO / GLASS DOORS CABINETS

ÉTAGÈRES INCLUSES / ESTANTES INCLUIDOS / INCLUDED SHELVES

MODÈLE / VARIANTES / VERSIONS	TYPE / TIPO / TYPE	DIMENSIONS / MEDIDAS / MEASUREMENTS	RÉFÉRENCE / REFERENCIA / CODE	
 <p>Armoire portes en verre Armario con puertas de vidrio Cabinet with glass doors</p>	Prof./ Depth. 42 cm	L.100 H.201,4 cm L.100 H.147 cm L.100 H.76,6 cm	<p>Mélamine Melamina Melamina</p> <p>345.505.-.- 345.503.-.- 345.507.-.-</p>	<p>Noyer Américain Nogal Americano American Walnut</p> <p>345.705.-.- 345.703.-.- 345.707.-.-</p>

 <p>Armoire portes en verre - portes en mélamine Puertas vidrio - puertas Upper glass doors with low doors</p>	Prof./ Depth. 42 cm	L.100 H.201,4 cm L.100 H.147 cm	<p>345.508.-.- 345.509.-.-</p>	<p>345.708.-.- 345.709.-.-</p>
-----------------------------------------------------------------------------------------------------------------------------------------------------------------------------------------------------------	---------------------	------------------------------------	------------------------------------	------------------------------------

 <p>Armoire portes en verre - DS Puertas vidrio - archivo Upper glass doors with low files</p>	Prof./ Depth. 42 cm	L.100 H.201,4 cm L.100 H.147 cm	<p>345.510.-.- 345.511.-.-</p>	<p>345.710.-.- 345.711.-.-</p>
-------------------------------------------------------------------------------------------------------------------------------------------------------------------------------------------	---------------------	------------------------------------	------------------------------------	------------------------------------

| FINITIONS | ACABADOS | FINISHES

VERRE / VIDRIO / GLASS | STRUCTURE / ESTRUCTURA / FRAME

Blanc Blanco White	<p>436 Blanc Blanco White</p> <p>889 Chêne Grisé Castaño Oscuro Dark Oak</p>	<p>439 Acacia Clair Acacia Clara Light Acacia</p> <p>440 Acacia Clair Acacia Clara Light Acacia</p>	<p>442 Acacia Foncé Acacia Oscura Dark Acacia</p> <p>443 Acacia Foncé Acacia Oscura Dark Acacia</p>	<p>886 Chêne Veiné Castaño Claro Oak</p> <p>887 Chêne Veiné Castaño Claro Oak</p>	<p>Bois vernis Madera Barnizada Wood veneer</p> <p>497 Noyer Américain Nogal Americano American Walnut</p> <p>498 Noyer Américain Nogal Americano American Walnut</p>
--------------------------	----------------------------------------------------------------------------------------------	---------------------------------------------------------------------------------------------------------------------	---------------------------------------------------------------------------------------------------------------------	---------------------------------------------------------------------------------------------------	-----------------------------------------------------------------------------------------------------------------------------------------------------------------------------------------------

open

Les besoins actuels de nos centres de travail ont évolué techniquement afin de satisfaire et de s'adapter à notre époque.

Las necesidades actuales en los centros de trabajo han evolucionado técnicamente para satisfacer y adaptarse a estos tiempos.

Current needs at work places have technically developed in order to satisfy us and to adjust to our present time.

PLATEAU / SOBRE / DESK TOP

Stratifiés / Estratificado / Stratified: 40 mm

STRUCTURE / ESTRUCTURA / FRAME

Aluminium anodisé:
Aluminio anodizado:
Anodised aluminium:

110 x 30 mm



FINITION STRUCTURE / ACABADO ESTRUCTURA / FRAME FINISH

Peinture époxy
Pintura epoxi
Epoxy paint

Bain de chrome
Baño cromado
Chrome

HAUTEUR / ALTURA / HEIGHT

73 cm

OPTION / OPCIÓN / OPTION

Voile de fond / Faldón / Modesty panel

BUREAU
DIRECTION

MESA DE
DIRECCIÓN

EXECUTIVE
DESK





Sous-mains en cuir.
Vade de piel.
Leather pad.



BUREAU
INDIVIDUEL
AVEC CRÉDENCE

MESA
INDIVIDUAL
CON CREDENCIA

EXECUTIVE
DESK WITH
SIDE CREDENZA

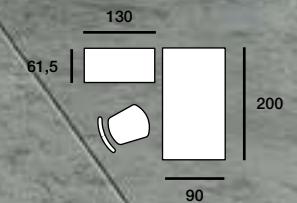

BUREAU DE
DIRECTION
AVEC RETOUR

MESA DE
DIRECCIÓN
CON ALA

EXECUTIVE
DESK WITH
RETURN



Vous pouvez compléter la composition avec un caisson à roulettes non visibles.
Se puede completar el conjunto con una cajonera con ruedas ocultas.
Executive mobile pedestal with hidden wheels is also available.

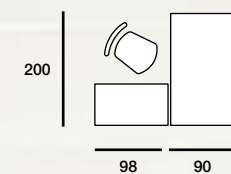









MODÈLES | VARIANTES | VERSIONS

MODÈLE / VARIANTES / VERSIONS	DIMENSIONS / MEDIDAS / MEASUREMENTS	RÉFÉRENCE / REFERENCIA / CODE
	220 x 90 cm 200 x 90 cm 180 x 90 cm	341.100.-.- 341.101.-.- 341.102.-.-

Bureau de direction
Mesa de dirección
Executive desk

FINITIONS | ACABADOS | FINISHES

STRUCTURE / ESTRUCTURA / FRAME | PLATEAU / SOBRE / DESK TOP

 Blanc Blanco White RAL 9016	144  Blanc Blanco White	145  Acacia Clair Acacia Clara Light Acacia	146  Acacia Foncé Acacia Oscura Dark Acacia
 Chromée Cromado Chrome	148  Blanc Blanco White	149  Acacia Clair Acacia Clara Light Acacia	150  Acacia Foncé Acacia Oscura Dark Acacia









COMPLÉMENTS | COMPLEMENTOS | COMPLEMENTS

MODÈLE / VARIANTES / VERSIONS	TYPE / TIPO / TYPE	DIMENSIONS / MEDIDAS / MEASUREMENTS	RÉFÉRENCE / REFERENCIA / CODE
	Prof./ Depth. 57 cm	L.158 H.61,5 cm L.130 H.61,5 cm L.115 H.61,5 cm	342.510.-.- 342.511.-.- 342.512.-.-



Crédence à roulettes et top en verre
Credencia con ruedas y sobre de vidrio
Side credenza with wheels and glass top

FINITIONS | ACABADOS | FINISHES

VERRE / VIDRIO / GLASS | STRUCTURE / ESTRUCTURA / FRAME

 Blanc Blanco White	436  Blanc Blanco White	439  Acacia Clair Acacia Clara Light Acacia	442  Acacia Foncé Acacia Oscura Dark Acacia
 Noir Negro Black	437  Blanc Blanco White	440  Acacia Clair Acacia Clara Light Acacia	443  Acacia Foncé Acacia Oscura Dark Acacia

COMPLÉMENTS | COMPLEMENTOS | COMPLEMENTS

MODÈLE / VARIANTES / VERSIONS	TYPE / TIPO / TYPE	DIMENSIONS / MEDIDAS / MEASUREMENTS	RÉFÉRENCE / REFERENCIA / CODE
	Prof./ Depth. 57 cm	L.115 H.61,5 cm L.87 H.61,5 cm L.72 H.61,5 cm	342.513.-.- 342.514.-.- 342.515.-.-
	3 Tiroirs / Cajones / Drawers	57 x 44 H.55,5 cm	Gamme basique Gama básica Basic range 342.500.-.-
	1 Tiroir / Cajón / Drawer + 1 DS / Archivo / File	57 x 44 H.55,5 cm	342.501.-.-

Crédence à roulettes
Credencia con ruedas
Side credenza with wheels

Cajonera con ruedas
Mobile pedestal



Sous-main en cuir
Vade
Leather pad













341.800.000



Cf. page 464 - Série 7
Ver pagina 464 - Serie 7
See page 464 - Serie 7

FINITIONS | ACABADOS | FINISHES

FAÇADES OU PORTES / DELANTERAS O PUERTAS / DOORS OR FRONTS | STRUCTURE / ESTRUCTURA / FRAME

 Blanc Blanco White	053  Blanc Blanco White	171  Acacia Clair Acacia Clara Light Acacia	174  Acacia Foncé Acacia Oscura Dark Acacia
 Acacia Clair Acacia Clara Light Acacia	168  Blanc Blanco White	103  Acacia Clair Acacia Clara Light Acacia	175  Acacia Foncé Acacia Oscura Dark Acacia
 Acacia Foncé Acacia Oscura Dark Acacia	169  Blanc Blanco White	172  Acacia Clair Acacia Clara Light Acacia	104  Acacia Foncé Acacia Oscura Dark Acacia

MODÈLES | VARIANTES | VERSIONS

ARMOIRES / ARMARIOS / CABINETS

ÉTAGÈRES INCLUSES / ESTANTES INCLUIDOS / INCLUDED SHELVES

MODÈLE / VARIANTES / VERSIONS	TYPE / TIPO / TYPE	DIMENSIONS / MEDIDAS / MEASUREMENTS	RÉFÉRENCE / REFERENCIA / CODE
	Prof./ Depth. 42 cm	L.100 H.201,4 cm L.100 H.147 cm L.100 H.76,6 cm	345.504.-.- 345.502.-.- 345.506.-.-
Armoire ouverte avec étagères Armario con estantes Cabinet shelves			
	Prof./ Depth. 42 cm	L.100 H.201,4 cm L.100 H.147 cm L.100 H.76,6 cm	345.505.-.- 345.503.-.- 345.507.-.-
Armoire portes en mélamine Armario con puertas de melamina Cabinet with doors			
	Prof./ Depth. 42 cm	L.100 H.76,6 cm	345.512.-.-
Armoire avec DS Armario con archivos Files cabinet			

FINITIONS | ACABADOS | FINISHES

PORTES / PUERTAS / DOORS | STRUCTURE / ESTRUCTURA / FRAME

	053 Blanc Blanco White	171 Acacia Clair Acacia Clara Light Acacia	174 Acacia Foncé Acacia Oscura Dark Acacia
	168 Blanc Blanco White	103 Acacia Clair Acacia Clara Light Acacia	175 Acacia Foncé Acacia Oscura Dark Acacia
	169 Blanc Blanco White	172 Acacia Clair Acacia Clara Light Acacia	104 Acacia Foncé Acacia Oscura Dark Acacia

MODÈLES | VARIANTES | VERSIONS



ARMOIRES PORTES EN VERRE / ARMARIOS PUERTAS VIDRIO / GLASS DOORS CABINETS

ÉTAGÈRES INCLUSES / ESTANTES INCLUIDOS / INCLUDED SHELVES

MODÈLE / VARIANTES / VERSIONS	TYPE / TIPO / TYPE	DIMENSIONS / MEDIDAS / MEASUREMENTS	RÉFÉRENCE / REFERENCIA / CODE
	Prof./ Depth. 42 cm	L.100 H.198 cm L.100 H.160 cm L.100 H.73 cm	345.505.-.- 345.503.-.- 345.507.-.-
Armoire portes en verre Armario con puertas de vidrio Cabinet with glass doors			
	Prof./ Depth. 42 cm	L.100 H.198 cm L.100 H.160 cm	345.508.-.- 345.509.-.-
Armoire portes en verre - portes en mélamine Puertas vidrio - puertas Upper glass doors with low doors			
	Prof./ Depth. 42 cm	L.100 H.198 cm L.100 H.160 cm	345.510.-.- 345.511.-.-
Armoire portes en verre - DS Puertas vidrio - archivo Upper glass doors with low files			

FINITIONS | ACABADOS | FINISHES

VERRE / VIDRIO / GLASS | STRUCTURE / ESTRUCTURA / FRAME

	436 Blanc Blanco White	439 Acacia Clair Acacia Clara Light Acacia	442 Acacia Foncé Acacia Oscura Dark Acacia
	437 Blanc Blanco White	440 Acacia Clair Acacia Clara Light Acacia	443 Acacia Foncé Acacia Oscura Dark Acacia

TABLES HAUTES
MESAS ALTAS
HIGH TABLES



168 | BORN



172 | NIL



176 | STAR



180 | TEMPO



184 | MAX 1



188 | MAX 2



192 | TAK



196 | ROCK 3



200 | ROL 1



204 | ROL 2

BORN

Un bureau au style nordique est possible avec la série BORN. Un design pratique et chaleureux qui répond à toutes les exigences pour créer des espaces calmes, ordonnés, propres et fonctionnels.

Una oficina con estilo nórdico es posible con la serie BORN. Un diseño práctico y cálido que reúne todos los requisitos para crear espacios tranquilos, ordenados, limpios y funcionales.

An office with Nordic style is possible with the BORN series. A practical and warm design due to the wooden legs and therefore able to create serene, neat, and useful spaces.

PLATEAU / SOBRE / DESK TOP

Mélamine / Melamina / Melamine: 25 mm
Stratifié / Estratificado / Stratified: 25 mm

Chant en ABS / Canto ABS / ABS edges

STRUCTURE / ESTRUCTURA / FRAME

Bois: 60 x 60 mm - 60 x 30 mm
Madera: 60 x 60 mm - 60 x 30 mm
Wood: 60 x 60 mm - 60 x 30 mm



FINITION STRUCTURE / ACABADO ESTRUCTURA / FRAME FINISH

Bois ou peinture époxy
Madera o pintura epoxi
Wood or epoxy paint

HAUTEUR / ALTURA / HEIGHT

105 cm

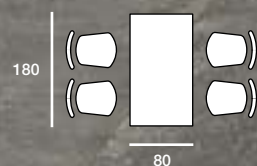















MODÈLES | VARIANTES | VERSIONS

MODÈLE / VARIANTES / VERSIONS	TYPE / TIPO / TYPE	DIMENSIONS / MEDIDAS / MEASUREMENTS		RÉFÉRENCE / REFERENCIA / CODE		
 <p>Table haute Mesa alta High table</p>	Coins droits / Cantos rectos / Square edges	H 105 cm	180 x 80 cm 160 x 80 cm 120 x 80 cm	639.102... 639.103... 639.105...	639.202... 639.203... 639.205...	639.302... 639.303... 639.305...
	Coins arrondis / Cantos redondeados / Round edges	H 105 cm	180 x 80 cm 160 x 80 cm 120 x 80 cm	639.152... 639.153... 639.155...	639.252... 639.253... 639.255...	639.352... 639.353... 639.355...

FINITIONS | ACABADOS | FINISHES

RENFORT + PIÉTEMENTS / ARMAZÓN + PATAS
/ REINFORCEMENT + FRAME

PLATEAU / SOBRE / DESK TOP

 Argent + Hêtre Plata + Haya Silver + Beech	 053 Blanc Blanco White	 054 Gris Gris Grey	 055 Hêtre Haya Beech	 061 Chêne Moyen Roble Maple
 Blanc + Hêtre Blanco + Haya White + Beech	 062 Poirier Peral Pear	 116 Wengué Wengue Wengue	 103 Acacia Clair Acacia Clara Light Acacia	 104 Acacia Foncé Acacia Oscura Dark Acacia
 Graphite + Hêtre Grafito + Haya Graphite + Beech	 007 Graphite Grafito Graphite	 272 Chêne Veiné Castaño Claro Oak	 273 Chêne Gris Castaño Oscuro Dark Oak	



NIL

Nil est une série de tables hautes harmonieuses et naturelles, au style chaleureux. Elle se caractérise par les bords arrondis du plateau et les pieds en bois hêtre massif.

Nil es una serie armónica y natural, de mesas altas, con estilo hogareño. Su principal característica reside en los cantos redondeados del sobre y en sus patas de madera de haya maciza.

Nil is a harmonious and pure high table with homely style thanks to its solid beech wood legs. As well it avoids the risk of a painful bump because of the rounded corners of its top.

PLATEAUX / SOBRE / DESK TOP

Mélamine / Melamina / Melamine: 25 mm
Stratifié / Estratificado / Stratified: 25 mm

Chant en ABS / Canto ABS / ABS edges

STRUCTURE / ESTRUCTURA / FRAME

Bois: Ø73 mm - Ø38 mm
Madera: Ø73 mm - Ø38 mm
Wood: Ø73-38



FINITION STRUCTURE / ACABADO ESTRUCTURA / FRAME FINISH

Bois et peinture époxy
Madera y pintura epoxi
Wood and epoxy paint

HAUTEUR / ALTURA / HEIGHT

105 cm

Avec ou sans repose-pieds / Con o sin reposapiés / With or without footrest

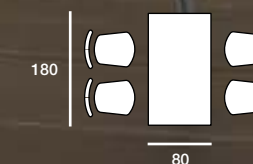

MODÈLES | VARIANTES | VERSIONS



MODÈLE / VARIANTES / VERSIONS	TYPE / TIPO / TYPE	DIMENSIONS / MEDIDAS / MEASUREMENTS		RÉFÉRENCE / REFERENCIA / CODE	
	Avec repose-pieds Con reposapiés With footrest	H 105 cm	180 x 80 cm	479.122.---	479.322.---
			160 x 80 cm	479.123.---	479.323.---
	Sans repose-pieds Sin reposapiés Without footrest	H 105 cm	180 x 80 cm	479.132.---	479.332.---
			160 x 80 cm	479.133.---	479.333.---
			120 x 80 cm	479.125.---	479.325.---
			120 x 80 cm	479.135.---	479.335.---

Table haute
Mesa alta
High table

FINITIONS | ACABADOS | FINISHES

RENFORT + PIÈTEMENTS / REFUERZO + PATAS
/ REINFORCEMENT + FRAME

PLATEAU / SOBRE / DESK TOP

	053	Blanc Blanco White	054	Gris Gris Grey	055	Hêtre Haya Beech	061	Chêne Moyen Roble Maple
	062	Poirier Peral Pear	116	Wengué Wengue Wengue	103	Acacia Clair Acacia Clara Light Acacia	104	Acacia Foncé Acacia Oscura Dark Acacia
	007	Graphite Grafito Graphite	272	Chêne Veiné Castaño Claro Oak	273	Chêne Grisé Castaño Oscuro Dark Oak		



star

Table haute avec structure métallique et repose-pieds central. STAR est une ampliation de la série STAR conçue pour simplifier la création d'un espace de travail.

Mesa alta con estructura metálica y reposapiés central. STAR nace fruto de la evolución de nuestro sistema de desarrollo y estudio. Con esta ampliación de la serie STAR se facilita el crear un espacio de trabajo más cómodo.

Metal frame high table with footrest. STAR is the result of an ongoing research and development system. This range make easier all kind of workspaces.

PLATEAU / SOBRE / DESK TOP

Mélamine / Melamina / Melamine: 25 mm
Stratifié / Estratificado / Stratified: 25 mm

Chant en ABS / Canto ABS / ABS edges

STRUCTURE / ESTRUCTURA / FRAME

Acier:
Acero: 50 x 50 x 1,8 mm
Steel:  50
prof./depth 80

FINITION STRUCTURE / ACABADO ESTRUCTURA / FRAME FINISH

Peinture époxy
Pintura epoxi
Epoxy paint

HAUTEUR / ALTURA / HEIGHT

105 cm



MODÈLES | VARIANTES | VERSIONS

















MODÈLE / VARIANTES / VERSIONS	TYPE / TIPO / TYPE	DIMENSIONS / MEDIDAS / MEASUREMENTS	RÉFÉRENCE / REFERENCIA / CODE
	Mixte / Mixta / Mixed	H 105 cm	 359.152.-.-
		180 x 80 cm	 359.252.-.-
		160 x 80 cm	 359.352.-.-
		120 x 80 cm	359.155.-.-

Table haute
Mesa alta
High table

FINITIONS | ACABADOS | FINISHES

STRUCTURE / ESTRUCTURA / FRAME | PLATEAU / SOBRE / DESK TOP

 Argent Plata Silver RAL 9006	 053 Blanc Blanco White	 054 Gris Gris Grey	 055 Hêtre Haya Beech	 061 Chêne Moyen Roble Maple
 Blanc Blanco White RAL 9016	 062 Poirier Peral Pear	 116 Wengué Wengue Wengue	 103 Acacia Clair Acacia Clara Light Acacia	 104 Acacia Foncé Acacia Oscura Dark Acacia
 Graphite Grafito Graphite RAL 7022	 007 Graphite Grafito Graphite	 272 Chêne Veiné Castaño Claro Oak	 273 Chêne Grisé Castaño Oscuro Dark Oak	



Avec repose-pieds.
Con reposapiés.
With footrest.

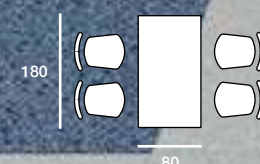

tempo

Polyvalence et lignes épurées sont les principales caractéristiques de cette série. Elle nous permet de créer des espaces de travail avec une apparence légère et simple.

Versatilidad y simplicidad de formas son las características principales de esta serie. Se consiguen espacios diversos con formas ligeras y simples.

Versatility and simplicity on shapes are the main features of this range. Create different working spaces with light and simple looking.

PLATEAU / SOBRE / DESK TOP

Mélamine / Melamina / Melamine: 25 mm
Stratifié / Estratificado / Stratified: 25 mm

Chant en ABS / Canto ABS / ABS edges

STRUCTURE / ESTRUCTURA / FRAME

Acier: 55 x 55 mm
Steel:



FINITION STRUCTURE / ACABADO ESTRUCTURA / FRAME FINISH

Peinture époxy
Pintura epoxi
Epoxy paint

HAUTEUR / ALTURA / HEIGHT

105 cm

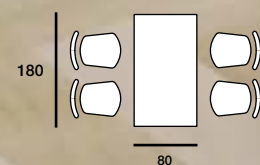

MODÈLES | VARIANTES | VERSIONS

MODÈLE / VARIANTES / VERSIONS	TYPE / TIPO / TYPE	DIMENSIONS / MEDIDAS / MEASUREMENTS	RÉFÉRENCE / REFERENCIA / CODE
	Mixte / Mixta / Mixed	H 105 cm	389.101.-... 389.201.-... 389.301.-...
		180 x 80 cm	389.102.-... 389.202.-... 389.302.-...
		160 x 80 cm 120 x 80 cm	389.104.-... 389.204.-... 389.304.-...

Table haute
Mesa alta
High table

FINITIONS | ACABADOS | FINISHES

STRUCTURE / ESTRUCTURA / FRAME | PLATEAU / SOBRE / DESK TOP

 Argent Plata Silver <small>RAL 9006</small>	 053 Blanc Blanco White	 054 Gris Gris Grey	 055 Hêtre Haya Beech	 061 Chêne Moyen Roble Maple
 Blanc Blanco White <small>RAL 9016</small>	 062 Poirier Peral Pear	 116 Wengué Wengue Wengue	 103 Acacia Clair Acacia Clara Light Acacia	 104 Acacia Foncé Acacia Oscura Dark Acacia
 Graphite Grafito Graphite <small>RAL 7022</small>	 007 Graphite Grafito Graphite	 272 Chêne Veiné Castaño Claro Oak	 273 Chêne Grisé Castaño Oscuro Dark Oak	

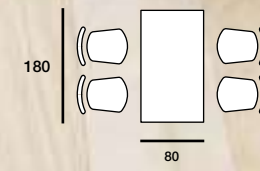

MAX 1

Une série de style industriel idéale pour la collaboration. La combinaison esthétique de l'acier et de la mélamine passe parfaitement ensemble et offre une solution pratique et professionnelle.

Una serie de estilo industrial ideal para la colaboración. La combinación estética de acero y de melamina se entrelaza a la perfección para ofrecer una solución práctica y profesional.

Max is a high table with an industrial style, unique frame. The rectangular variant also includes a practical and useful shelf underneath the tabletop to stow personal items when having a formal or informal conversation.

PLATEAU / SOBRE / DESK TOP

Mélamine / Melamina / Melamine: 25 mm
Stratifié / Estratificado / Stratified: 25 mm

Chant en ABS / Canto ABS / ABS edges

STRUCTURE / ESTRUCTURA / FRAME

Acier: Ø30 mm
Acero: Ø30 mm
Steel:



FINITION STRUCTURE / ACABADO ESTRUCTURA / FRAME FINISH

Peinture époxy
Pintura epoxi
Epoxy paint

HAUTEUR / ALTURA / HEIGHT

105 cm

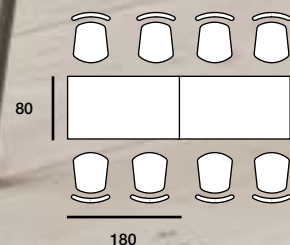

MODÈLES | VARIANTES | VERSIONS

MODÈLE / VARIANTES / VERSIONS	TYPE / TIPO / TYPE	DIMENSIONS / MEDIDAS / MEASUREMENTS	RÉFÉRENCE / REFERENCIA / CODE
	Mixte / Mixta / Mixed	H 105 cm	
		180 x 80 cm	709.152.---
		160 x 80 cm	709.153.---
		120 x 80 cm	709.155.---

Table haute
Mesa alta
High table

FINITIONS | ACABADOS | FINISHES

STRUCTURE / ESTRUCTURA / FRAME | PLATEAU / SOBRE / DESK TOP

 Argent Plata Silver RAL 9006	 053 Blanc Blanco White	 054 Gris Gris Grey	 055 Hêtre Haya Beech	 061 Chêne Moyen Roble Maple
 Blanc Blanco White RAL 9016	 062 Poirier Peral Pear	 116 Wengué Wengue Wengue	 103 Acacia Clair Acacia Clara Light Acacia	 104 Acacia Foncé Acacia Oscura Dark Acacia
 Graphite Grafito Graphite RAL 7022	 007 Graphite Grafito Graphite	 272 Chêne Veiné Castaño Claro Oak	 273 Chêne Grisé Castaño Oscuro Dark Oak	

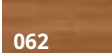
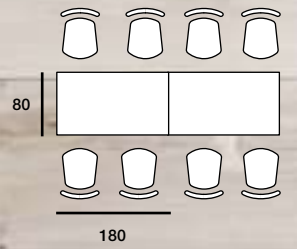

Tablette inférieure.
Estante inferior.
Bottom shelf.

MAX 2

Une série de style industriel idéale pour la collaboration. La combinaison esthétique de l'acier et de la mélamine passe parfaitement ensemble et offre une solution pratique et professionnelle.

Una serie de estilo industrial ideal para la colaboración. La combinación estética de acero y de melamina se entrelaza a la perfección para ofrecer una solución práctica y profesional.

Max is a high table with an industrial style, unique frame. The rectangular variant also includes a practical and useful shelf underneath the tabletop to stow personal items when having a formal or informal conversation.

PLATEAU / SOBRE / DESK TOP

Mélamine / Melamina / Melamine: 25 mm
Stratifié / Estratificado / Stratified: 25 mm

Chant en ABS / Canto ABS / ABS edges

STRUCTURE / ESTRUCTURA / FRAME

Acier: Ø30 mm
Steel:



FINITION STRUCTURE / ACABADO ESTRUCTURA / FRAME FINISH

Peinture époxy
Pintura epoxi
Epoxy paint

HAUTEUR / ALTURA / HEIGHT

105 cm



MODÈLES | VARIANTES | VERSIONS



MODÈLE / VARIANTES / VERSIONS	TYPE / TIPO / TYPE	DIMENSIONS / MEDIDAS / MEASUREMENTS		RÉFÉRENCE / REFERENCIA / CODE		
	Mixte / Mixta / Mixed	H 105 cm	Ø 100 cm Ø 80 cm	 709.176.-.- 709.177.-.-	 709.276.-.- 709.277.-.-	 709.376.-.- 709.377.-.-

Table haute ronde
Mesa alta redonda
Round high table

FINITIONS | ACABADOS | FINISHES

STRUCTURE / ESTRUCTURA / FRAME | PLATEAU / SOBRE / DESK TOP

 Argent Plata Silver RAL 9006	 053 Blanc Blanco White	 054 Gris Grey	 055 Hêtre Haya Beech	 061 Chêne Moyen Roble Maple
 Blanc Blanco White RAL 9016	 062 Poirier Peral Pear	 116 Wengué Wengue	 103 Acacia Clair Acacia Clara Light Acacia	 104 Acacia Foncé Acacia Oscura Dark Acacia
 Graphite Grafito Graphite RAL 7022	 007 Graphite Grafito Graphite	 272 Chêne Veiné Castaño Claro Oak	 273 Chêne Grisé Castaño Oscuro Dark Oak	



Avec repose-pieds.
Con reposapiés.
With footrest.



TAK

C'est une série de direction aux lignes droites et élégantes qui s'éloigne de tout ce qui est prétentieux.

Es una serie direccional que se armoniza para crear un sitio de trabajo funcional y práctico, de líneas rectas y puras en todo su conjunto.

TAK is a solid, straight lined and at the same time elegant looking executive range.

PLATEAU / SOBRE / DESK TOP

Mélamine / Melamina / Melamine: 40 mm

Chant en ABS / Canto ABS / ABS edges

STRUCTURE / ESTRUCTURA / FRAME

Mélamine / Melamina / Melamine:

40



FINITION STRUCTURE / ACABADO ESTRUCTURA / FRAME FINISH

Mélamine
Melamina
Melamine

HAUTEUR / ALTURA / HEIGHT

105 cm

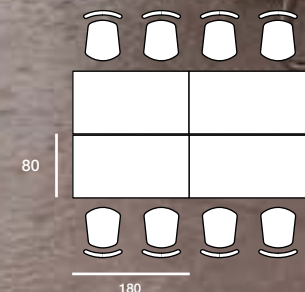

MODÈLES | VARIANTES | VERSIONS

MODÈLE / VARIANTES / VERSIONS	TYPE / TIPO / TYPE	DIMENSIONS / MEDIDAS / MEASUREMENTS		RÉFÉRENCE / REFERENCIA / CODE
 <p>Table haute Mesa alta High table</p>	Structure en bois / Estructura de madera / Wood frame	H 105 cm	180 x 80 cm 160 x 80 cm 120 x 80 cm	569.105... 569.106... 569.108...

FINITIONS | ACABADOS | FINISHES

053	Blanc Blanco White	103	Acacia Clair Acacia Clara Light Acacia	104	Acacia Foncé Acacia Oscura Dark Acacia	272	Chêne Veiné Castaño Claro Oak	273	Chêne Grisé Castaño Oscuro Dark Oak
-----	--------------------------	-----	----------------------------------------------	-----	----------------------------------------------	-----	-------------------------------------	-----	-------------------------------------------

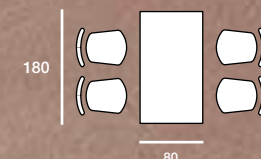

ROCK 3

La série ROCK 3 se caractérise par son pied panneau mélaminé. Elle vous permet de meubler votre bureau au meilleur prix possible, avec une grande gamme de finitions.

ROCK 3 se caracteriza por un lateral tipo panel. Permite amueblar las oficinas al mejor precio, con gran variedad de acabados.

ROCK 3 melamine panel legs range is an affordable, high quality and stylish furniture, enabling customers to furnish their office space within a specific budget,



PLATEAU / SOBRE / DESK TOP

Mélamine / Melamina / Melamine: 25 mm
Stratifié / Estratificado / Stratified: 25 mm

Chant en ABS / Canto ABS / ABS edges

STRUCTURE / ESTRUCTURA / FRAME

Mélamine / Melamina / Melamine:

25



HAUTEUR / ALTURA / HEIGHT

105 cm



MODÈLES | VARIANTES | VERSIONS

MODÈLE / VARIANTES / VERSIONS	TYPE / TIPO / TYPE	DIMENSIONS / MEDIDAS / MEASUREMENTS	RÉFÉRENCE / REFERENCIA / CODE
 <p>Table haute Mesa alta High table</p>	Structure en bois / Estructura de madera / Wood frame	H 105 cm 180 x 80 cm 160 x 80 cm 120 x 80 cm	439.101... 439.102... 439.104...

FINITIONS | ACABADOS | FINISHES

053	Blanc Blanco White	054	Gris Gris Grey	055	Hêtre Haya Beech	061	Chêne Moyen Roble Maple	062	Poirier Peral Pear
116	Wengué Wengue Wengue	103	Acacia Clair Acacia Clara Light Acacia	104	Acacia Foncé Acacia Oscura Dark Acacia	007	Graphite Grafito Graphite	272	Chêne Veiné Castaño Claro Oak
273	Chêne Grisé Castaño Oscuro Dark Oak								

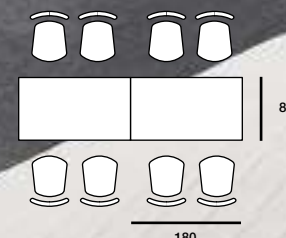

ROL 1

Une série de tables hautes et de taille standard capables de s'adapter efficacement à de multiples espaces. Rol se caractérise par deux variantes importantes: table ronde (ROL 1) et table carrée (ROL 2).

Una serie de mesas altas y de medida estándar capaz de adaptarse eficazmente a múltiples espacios. Rol se caracteriza por disponer de dos variantes significativas: mesa redonda (ROL 1) y cuadrada (ROL 2).

Rol is a series of high and standard-size tables capable of effectively adapting to multiple spaces. Rol is characterized by having two significant variants: round (ROL 1) and square (ROL 2) table, each of them also available as high or low.

PLATEAU / SOBRE / DESK TOP

Mélamine / Melamina / Melamine: 25 mm
Stratifié / Estratificado / Stratified: 25 mm

Chant en ABS / Canto ABS / ABS edges

STRUCTURE / ESTRUCTURA / FRAME

Acier: Ø114 mm
Steel: 114



FINITION STRUCTURE / ACABADO ESTRUCTURA / FRAME FINISH



Peinture époxy
Pintura epoxi
Epoxy paint

HAUTEUR / ALTURA / HEIGHT

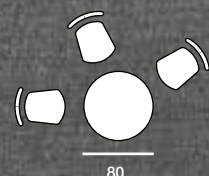
105 cm
73 cm







MODÈLES | VARIANTES | VERSIONS

MODÈLE / VARIANTES / VERSIONS	TYPE / TIPO / TYPE	DIMENSIONS / MEDIDAS / MEASUREMENTS		RÉFÉRENCE / REFERENCIA / CODE		
	Mixte / Mixta / Mixed	H 105 cm	Ø100 cm Ø80 cm	719.156-... 719.157-...	719.256-... 719.257-...	719.356-... 719.357-...
Table haute ronde Mesa alta redonda Round high table						
	Mixte / Mixta / Mixed	H 73 cm	Ø80 cm	719.167-...	719.267-...	719.367-...
Table H.73 Mesa H.73 H.73 Table						

FINITIONS | ACABADOS | FINISHES

STRUCTURE / ESTRUCTURA / FRAME | PLATEAU / SOBRE / DESK TOP

 Argent Plata Silver RAL 9006	 Blanc Blanco White 053	 Gris Gris Grey 054	 Hêtre Haya Beech 055	 Chêne Moyen Roble Maple 061
 Blanc Blanco White RAL 9016	 Poirier Peral Pear 062	 Wengué Wengue Wengue 116	 Acacia Clair Acacia Clara Light Acacia 103	 Acacia Foncé Acacia Oscura Dark Acacia 104
 Graphite Grafito Graphite RAL 7022	 Graphite Grafito Graphite 007	 Chêne Veiné Castaño Claro Oak 272	 Chêne Grisé Castaño Oscuro Dark Oak 273	

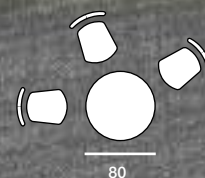

ROL 2

Une série de tables hautes et de taille standard capables de s'adapter efficacement à de multiples espaces. Rol se caractérise par deux variantes importantes: table ronde (ROL 1) et table carrée (ROL 2).

Una serie de mesas altas y de medida estándar capaz de adaptarse eficazmente a múltiples espacios. Rol se caracteriza por disponer de dos variantes significativas: mesa redonda (ROL 1) y cuadrada (ROL 2).

Rol is a series of high and standard-size tables capable of effectively adapting to multiple spaces. Rol is characterized by having two significant variants: round (ROL 1) and square (ROL 2) table, each of them also available as high or low.

PLATEAU / SOBRE / DESK TOP

Mélangine / Melamina / Melamine: 25 mm
Stratifié / Estratificado / Stratified: 25 mm

Chant en ABS / Canto ABS / ABS edges

STRUCTURE / ESTRUCTURA / FRAME

Acier: Ø114 mm
Acero: Ø114 mm
Steel: Ø114 mm



FINITION STRUCTURE / ACABADO ESTRUCTURA / FRAME FINISH



Peinture époxy
Pintura epoxi
Epoxy paint

HAUTEUR / ALTURA / HEIGHT

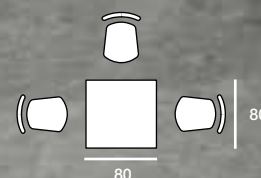
105 cm
73 cm



MODÈLES | VARIANTES | VERSIONS

MODÈLE / VARIANTES / VERSIONS	TYPE / TIPO / TYPE	DIMENSIONS / MEDIDAS / MEASUREMENTS		RÉFÉRENCE / REFERENCIA / CODE		
	Mixte / Mixta / Mixed	H 105 cm	100 x 100 cm 80 x 80 cm	719.176.-.- 719.177.-.-	719.276.-.- 719.277.-.-	719.376.-.- 719.377.-.-
Table haute Mesa alta High table						
	Mixte / Mixta / Mixed	H 73 cm	100 x 100 cm 80 x 80 cm	719.186.-.- 719.187.-.-	719.286.-.- 719.287.-.-	719.386.-.- 719.387.-.-
Table H.73 Mesa H.73 H.73 Table						

FINITIONS | ACABADOS | FINISHES

STRUCTURE / ESTRUCTURA / FRAME | PLATEAU / SOBRE / DESK TOP

 RAL 9006	Argent Plata Silver	 053	Blanc Blanco White	 054	Gris Gris Grey	 055	Hêtre Haya Beech	 061	Chêne Moyen Roble Maple
 RAL 9016	Blanc Blanco White	 062	Poirier Peral Pear	 116	Wengué Wengue Wengue	 103	Acacia Clair Acacia Clara Light Acacia	 104	Acacia Foncé Acacia Oscura Dark Acacia
 RAL 7022	Graphite Grafito Graphite	 007	Graphite Grafito Graphite	 272	Chêne Veiné Castaño Claro Oak	 273	Chêne Grisé Castaño Oscuro Dark Oak		

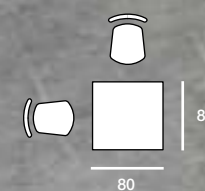

TABLES DE RÉUNION
MESAS DE REUNIÓN
MEETING TABLES



210 | UP



214 | STAR



218 | BORN



222 | TEMPO



226 | ECO



230 | SIGMA



234 | TONO



238 | TAK



244 | OPEN



248 | ROCK



254 | ROL 1



258 | ROL 2

Up

Cette gamme de bureaux opératifs au design contemporain et futuriste existe en deux versions: fixe ou réglable. La version réglable électriquement permet d'ajuster la hauteur au besoin de l'utilisateur.

Mesa operativa con un diseño moderno y futurista. Hay dos modelos a escoger: la fija o la elevable. La mesa elevable dispone de un sistema eléctrico que permite adaptar la altura de la mesa según las necesidades del usuario.

This office table has a modern and futurist look. There are two options: fixed or height adjustable frame. Each user can choose its favorite table height lifting the desk with an electric engine.

PLATEAU / SOBRE / DESK TOP

Mélamine / Melamina / Melamine: 25 mm
Stratifié / Estratificado / Stratified:
Phénolique / Fenolico / Phenolic: 13 mm

Chant en ABS / Canto ABS / ABS edges

STRUCTURE / ESTRUCTURA / FRAME

Acier: 70 x 70 x 2 mm
Acero: 70 x 70 x 2 mm
Steel: 70 x 70 x 2 mm

FINITION STRUCTURE / ACABADO ESTRUCTURA / FRAME FINISH

Peinture époxy
Pintura epoxi
Epoxy paint





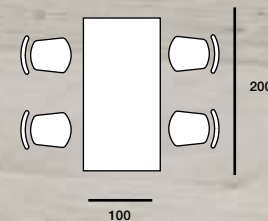



HAUTEUR / ALTURA / HEIGHT

73 mm

















MODÈLES | VARIANTES | VERSIONS

HAUTEUR FIXE / FIJAS / FIXED HEIGHT

MODÈLE / VARIANTES / VERSIONS	DIMENSIONS / MEDIDAS / MEASUREMENTS	RÉFÉRENCE / REFERENCIA / CODE		
 <p>Table de réunion rectangulaire Mesa de reunión rectangular Rectangular meeting table</p>	220 x 100 cm 200 x 100 cm	 594.100.-... 594.101.-...	 594.200.-... 594.201.-...	 594.300.-... 594.301.-...
 <p>Table de réunion forme tonneau Mesa de reunión tonel Barrel meeting table</p>	220 x 100 cm 200 x 100 cm	 594.110.-... 594.111.-...	 594.210.-... 594.211.-...	 594.310.-... 594.311.-...

FINITIONS | ACABADOS | FINISHES

STRUCTURE / ESTRUCTURA / FRAME | PLATEAU / SOBRE / DESKTOP

 RAL 9006 Argent Plata Silver	 053 Blanc Blanco White	 054 Gris Gris Grey	 055 Hêtre Haya Beech	 061 Chêne Moyen Roble Maple
 RAL 9016 Blanc Blanco White	 062 Poirier Peral Pear	 116 Wengué Wengue Wengue	 103 Acacia Clair Acacia Clara Light Acacia	 104 Acacia Foncé Acacia Oscura Dark Acacia
 RAL 7022 Graphite Grafito Graphite	 007 Graphite Grafito Graphite	 272 Chêne Veiné Castaño Claro Oak	 273 Chêne Gris Castaño Oscuro Dark Oak	



star

La gamme STAR est le fruit de l'évolution de nos recherches et système de développement.

STAR es, sin duda, una apuesta de futuro en el desarrollo y evolución del mobiliario de oficina. Fruto de la evolución del sistema de desarrollo y estudio, nace este programa.

STAR is the future in office furniture. It was born as a result of ongoing research and development systems.

PLATEAU / SOBRE / DESK TOP

Mélamine / Melamina / Melamine: 25 mm
Stratifié / Estratificado / Stratified: 25 mm
Phénolique / Fenólico / Phenolic: 13 mm

Chant en ABS / Canto ABS / ABS edges

STRUCTURE / ESTRUCTURA / FRAME

Acier: 60 x 60 x 1,5 mm
Steel: 60 x 60 x 1,5 mm



FINITION STRUCTURE / ACABADO ESTRUCTURA / FRAME FINISH

Peinture époxy
Pintura epoxi
Epoxy paint

HAUTEUR / ALTURA / HEIGHT

73 mm

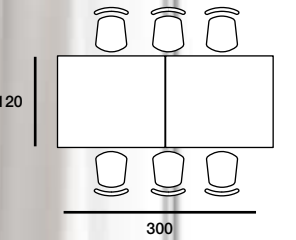









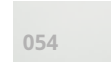

MODÈLES | VARIANTES | VERSIONS

PIÉTEMENT OUVERT / PATA ABIERTA / U-SHAPE LEG

MODÈLE / VARIANTES / VERSIONS	DIMENSIONS / MEDIDAS / MEASUREMENTS	RÉFÉRENCE / REFERENCIA / CODE		
 <p>Tables de réunion Mesas de reunión Meeting tables</p>	450 x 120 cm	354.104.---	354.204.---	354.304.---
	300 x 120 cm	354.103.---	354.203.---	354.303.---
	250 x 120 cm	354.102.---	354.202.---	354.302.---
	200 x 120 cm	354.101.---	354.201.---	354.301.---
	120 x 120 cm	354.100.---	354.200.---	354.300.---
	480 x 160 cm	354.107.---	354.207.---	354.307.---
	320 x 160 cm	354.106.---	354.206.---	354.306.---
	160 x 160 cm	354.105.---	354.205.---	354.305.---

FINITIONS | ACABADOS | FINISHES

STRUCTURE / ESTRUCTURA / FRAME | PLATEAU / SOBRE / DESKTOP

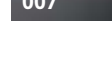
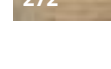
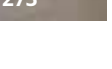
 Argent Plata Silver <small>RAL 9006</small>	 053 Blanc Blanco White	 054 Gris Gris Grey	 055 Hêtre Haya Beech	 061 Chêne Moyen Roble Maple
 Blanc Blanco White <small>RAL 9016</small>	 062 Poirier Peral Pear	 116 Wengué Wengue Wengue	 103 Acacia Clair Acacia Clara Light Acacia	 104 Acacia Foncé Acacia Oscura Dark Acacia
 Graphite Grafito Graphite <small>RAL 7022</small>	 007 Graphite Grafito Graphite	 272 Chêne Veiné Castaño Claro Oak	 273 Chêne Grisé Castaño Oscuro Dark Oak	

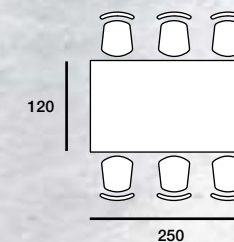

BORN

Un bureau au style nordique est possible avec la série BORN. Un design pratique et chaleureux qui répond à toutes les exigences pour créer des espaces calmes, ordonnés, propres et fonctionnels.

Una oficina con estilo nórdico es posible con la serie BORN. Un diseño práctico y cálido que reúne todos los requisitos para crear espacios tranquilos, ordenados, limpios y funcionales.



An office with Nordic style is possible with the BORN series. A practical and warm design due to the wooden legs and therefore able to create serene, neat, and useful spaces.

PLATEAU / SOBRE / DESKTOP

Mélamine / Melamina / Melamine: 25 mm

Chant en ABS / Canto ABS / ABS edges

STRUCTURE / ESTRUCTURA / FRAME

Bois:	60 x 60 mm - 60 x 30 mm	60	
Madera:			30
Wood:			
Acier:	50 x 30 x 2 mm	50	
Acero:			30
Steel:			
Mixte:	50 x 30 x 2 mm	50	
Mixta:			30
Steel+Wood:			

FINITION STRUCTURE / ACABADO ESTRUCTURA / FRAME FINISH

Bois ou peinture époxy
Madera o pintura epoxi
Wood or epoxy paint

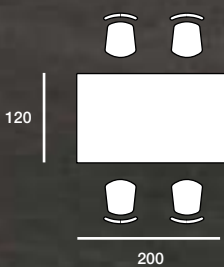

HAUTEUR / ALTURA / HEIGHT

73 mm















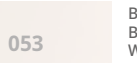
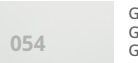

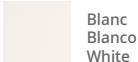
MODÈLES | VARIANTES | VERSIONS

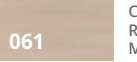
MODÈLE / VARIANTES / VERSIONS	TYPE / TIPO / TYPE	DIMENSIONS / MEDIDAS / MEASUREMENTS	RÉFÉRENCE / REFERENCIA / CODE			
	Métallique / Metal / Metal	450 x 120 cm 300 x 120 cm 250 x 120 cm 200 x 120 cm 120 x 120 cm	 634.104.-.- 634.204.-.- 634.304.-.-  634.103.-.- 634.203.-.- 634.303.-.-  634.102.-.- 634.202.-.- 634.302.-.-  634.101.-.- 634.201.-.- 634.301.-.-  634.100.-.- 634.200.-.- 634.300.-.-			
				Mixte / Mixta / Metal + Wood	450 x 120 cm 300 x 120 cm 250 x 120 cm 200 x 120 cm 120 x 120 cm	 634.604.-.- 634.704.-.- 634.804.-.-  634.603.-.- 634.703.-.- 634.803.-.-  634.602.-.- 634.702.-.- 634.802.-.-  634.601.-.- 634.701.-.- 634.801.-.-  634.600.-.- 634.700.-.- 634.800.-.-
						<p>Tables de réunion Mesas de reunión Meeting tables</p>

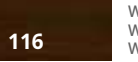
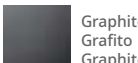
	En bois / Madera / Wood	450 x 120 cm 300 x 120 cm 241 x 120 cm 200 x 120 cm 120 x 120 cm	 634.504.-.- 634.503.-.- 634.502.-.- 634.501.-.- 634.500.-.-
<p>Tables de réunion Mesas de reunión Meeting tables</p>			

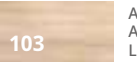
FINITIONS | ACABADOS | FINISHES

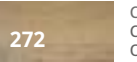
STRUCTURE / ESTRUCTURA / FRAME | PLATEAU / SOBRE / DESKTOP

 Argent Plata Silver RAL 9006	 Argent + Hêtre Plata + Haya Silver + Beech veneer	 Hêtre Haya Beech veneer	 053 Blanc Blanco White	 054 Gris Gris Grey	 055 Hêtre Haya Beech
 Blanc Blanco White RAL 9016	 Blanc + Hêtre Blanco + Haya White + Beech veneer		 061 Chêne Moyen Roble Maple	 062 Poirier Peral Pear	 116 Wengué Wengue Wengue
 Graphite Grafito Graphite RAL 7022	 Graphite + Hêtre Grafito + Haya Graphite + Beech veneer		 103 Acacia Clair Acacia Clara Light Acacia	 104 Acacia Foncé Acacia Oscura Dark Acacia	 007 Graphite Grafito Graphite
			 272 Chêne Veiné Castaño Claro Oak	 273 Chêne Gris Castaño Oscuro Dark Oak	

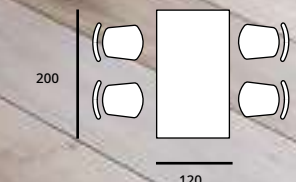

tempo

Polyvalence et lignes épurées sont les principales caractéristiques de cette série. Elle nous permet de créer des espaces de travail avec une apparence légère et simple.

Versatilidad y simplicidad de formas son las características principales de esta serie. Se consiguen espacios diversos con formas ligeras y simples.

Versatility and simplicity on shapes are the main features of this range. Create different working spaces with light and simple looking.

PLATEAU / SOBRE / DESK TOP

Mélamine / Melamina / Melamine: 25 mm
Chant en ABS / Canto ABS / ABS edges

STRUCTURE / ESTRUCTURA / FRAME

Acier: 55 mm x 55 mm x 1,5 mm
Steel:  55
1,5

FINITION STRUCTURE / ACABADO ESTRUCTURA / FRAME FINISH

Peinture époxy
Pintura epoxi
Epoxy paint

HAUTEUR / ALTURA / HEIGHT

Fixe: 73 mm Réglable: 80,6 > 63 mm
Fija: 73 mm Regulable: 80,6 > 63 mm
Fixed: 73 mm Adjustable:

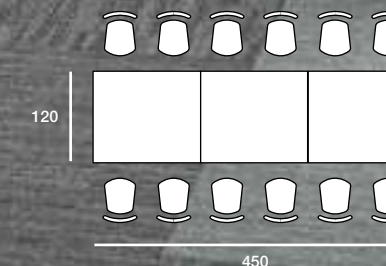

MODÈLES | VARIANTES | VERSIONS

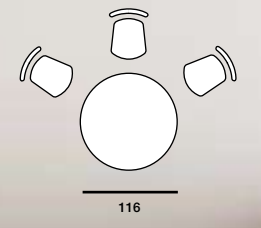

MODÈLE / VARIANTES / VERSIONS	DIMENSIONS / MEDIDAS / MEASUREMENTS	RÉFÉRENCE / REFERENCIA / CODE	
	450 x 120 cm 300 x 120 cm	H. fixe / fija / fixed 384.050.--- 384.055.---	H. réglable / regulable / adjustable 384.150.--- 384.155.---
	250 x 120 cm 200 x 120 cm 120 x 120 cm	384.021.--- 384.022.--- 384.026.---	384.121.--- 384.122.--- 384.126.---
	Ø 116 cm	404.132.---	

Tables de réunion
Mesas de reunión
Meeting tables

FINITIONS | ACABADOS | FINISHES

STRUCTURE / ESTRUCTURA / FRAME | PLATEAU / SOBRE / DESK TOP

	060 Blanc Blanco White	064 Gris Gris Grey	065 Hêtre Haya Beech	066 Chêne Moyen Roble Maple	067 Poirier Peral Pear
	068 Wengué Wengue Wengue	706 Acacia Clair Acacia Clara Light Acacia	707 Acacia Foncé Acacia Oscura Dark Acacia	020 Graphite Grafito Graphite	031 Chêne Veiné Castaño Claro Oak
	032 Chêne Gris Castaño Oscuro Dark Oak				
	096 Blanc Blanco White	097 Gris Gris Grey	098 Hêtre Haya Beech	099 Chêne Moyen Roble Maple	100 Poirier Peral Pear
	101 Wengué Wengue Wengue	709 Acacia Clair Acacia Clara Light Acacia	710 Acacia Foncé Acacia Oscura Dark Acacia	017 Graphite Grafito Graphite	166 Chêne Veiné Castaño Claro Oak
	167 Chêne Gris Castaño Oscuro Dark Oak				
	163 Blanc Blanco White	180 Gris Gris Grey	181 Hêtre Haya Beech	182 Chêne Moyen Roble Maple	183 Poirier Peral Pear
	184 Wengué Wengue Wengue	715 Acacia Clair Acacia Clara Light Acacia	716 Acacia Foncé Acacia Oscura Dark Acacia	113 Graphite Grafito Graphite	206 Chêne Veiné Castaño Claro Oak
	208 Chêne Gris Castaño Oscuro Dark Oak				

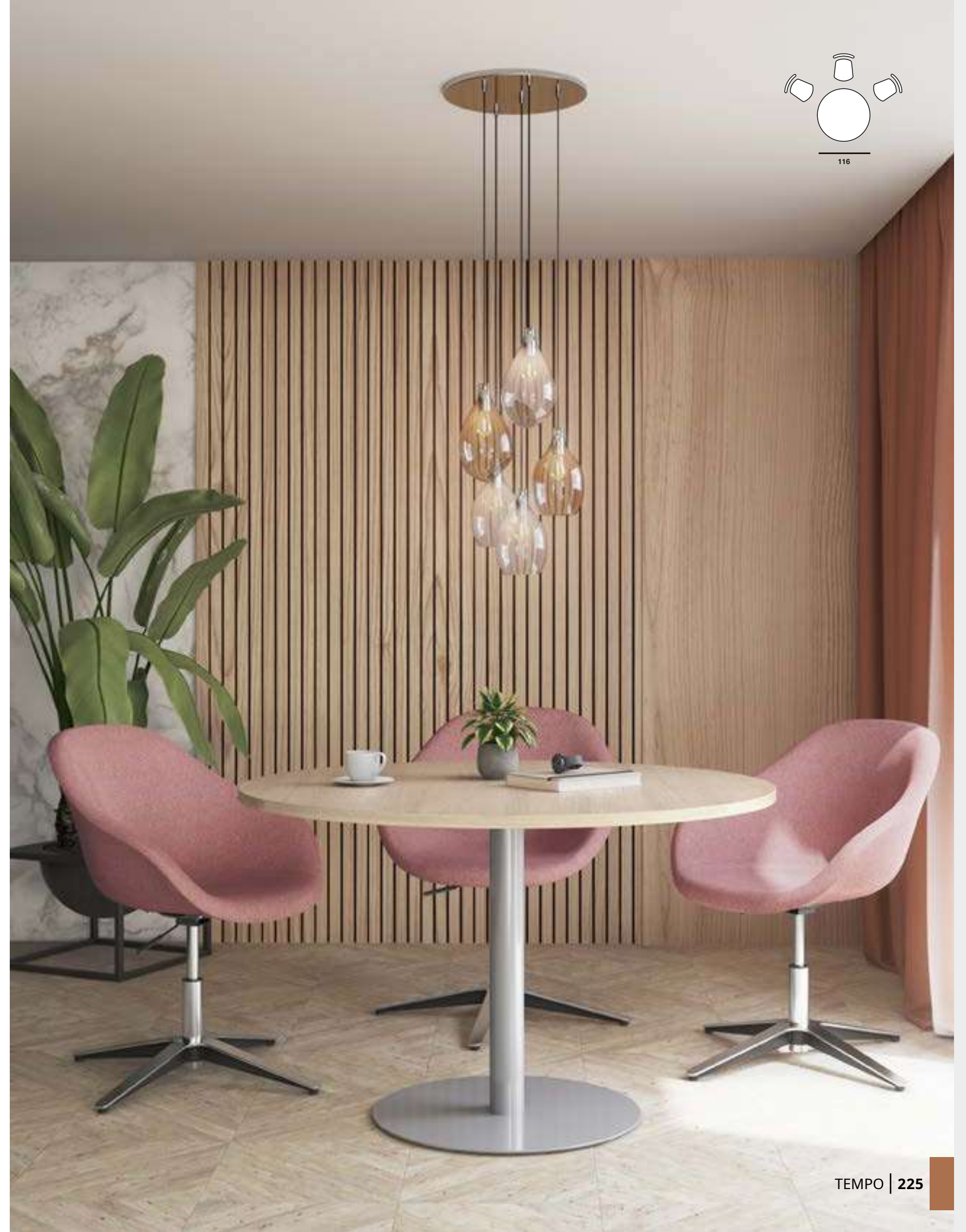

ECO

ECO, une série modulaire et polyvalente résolument adaptée aux besoins du marché.

Culminación de esfuerzos encaminados a satisfacer las necesidades de trabajo más exigentes.

This range is the result of many efforts seeking to meet the most demanding working needs from the simplicity of shapes and design.

PLATEAU / SOBRE / DESK TOP

Mélamine / Melamina / Melamine:
Stratifié / Estratificado / Stratified: 25 mm

Chant en ABS / Canto ABS / ABS edges

STRUCTURE / ESTRUCTURA / FRAME

Acier
Acero
Steel 60 x 60 x 2 mm



FINITION STRUCTURE / ACABADO ESTRUCTURA / FRAME FINISH



Peinture époxy
Pintura epoxi
Epoxy paint

HAUTEUR / ALTURA / HEIGHT

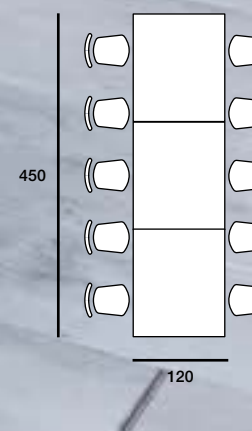
73 mm





MODÈLES | VARIANTES | VERSIONS

MODÈLE / VARIANTES / VERSIONS	DIMENSIONS / MEDIDAS / MEASUREMENTS	RÉFÉRENCE / REFERENCIA / CODE
	450 x 120 cm 300 x 120 cm	394.050.-.- 394.055.-.-
	250 x 120 cm 200 x 120 cm 120 x 120 cm	394.021.-.- 394.022.-.- 394.026.-.-
	Ø 116 cm	404.132.-.-

Tables de réunion
Mesas de reunión
Meeting tables

FINITIONS | ACABADOS | FINISHES

STRUCTURE / ESTRUCTURA / FRAME | PLATEAU / SOBRE / DESK TOP

	060 Blanc Blanco White	064 Gris Gris Grey	065 Hêtre Haya Beech	066 Chêne Moyen Roble Maple	067 Poirier Peral Pear
	068 Wengué Wengue Wengue	706 Acacia Clair Acacia Clara Light Acacia	707 Acacia Foncé Acacia Oscura Dark Acacia	020 Graphite Grafito Graphite	031 Chêne Veiné Castaño Claro Oak
	032 Chêne Grisé Castaño Oscuro Dark Oak				
	096 Blanc Blanco White	097 Gris Gris Grey	098 Hêtre Haya Beech	099 Chêne Moyen Roble Maple	100 Poirier Peral Pear
	101 Wengué Wengue Wengue	709 Acacia Clair Acacia Clara Light Acacia	710 Acacia Foncé Acacia Oscura Dark Acacia	017 Graphite Grafito Graphite	166 Chêne Veiné Castaño Claro Oak
	167 Chêne Grisé Castaño Oscuro Dark Oak				

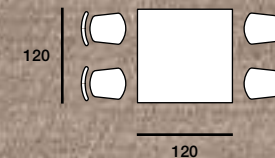

sigma

SIGMA améliore votre poste de travail grâce à ses nouveaux concepts ergonomiques et esthétiques.

SIGMA mejora los puestos de trabajo aportándoles nuevos conceptos ergonómicos y estéticos.

SIGMA improves workplaces by its ergonomics features and design concepts.



PLATEAUX / SOBRE / DESK TOP

Mélamine / Melamina / Melamine: 25 mm
Chant en ABS / Canto ABS / ABS edges

STRUCTURE / ESTRUCTURA / FRAME

Acier:
Acero:
Steel: 920 x 920 mm



FINITION STRUCTURE / ACABADO ESTRUCTURA / FRAME FINISH

Peinture époxy
Pintura epoxi
Epoxy paint

HAUTEUR / ALTURA / HEIGHT

73 mm

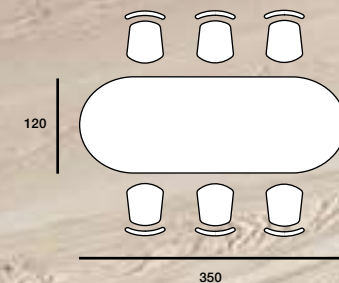

MODÈLES | VARIANTES | VERSIONS

MODÈLE / VARIANTES / VERSIONS	DIMENSIONS / MEDIDAS / MEASUREMENTS	RÉFÉRENCE / REFERENCIA / CODE
	500 x 120 cm 450 x 120 cm 400 x 120 cm 350 x 120 cm 300 x 120 cm	234.104.-... 234.106.-... 234.108.-... 234.110.-... 234.112.-...
	250 x 120 cm 200 x 120 cm	234.114.-... 234.116.-...
	Ø 130 cm Ø 116 cm	234.118.-... 234.120.-...

Tables de réunion
Mesas de reunión
Meeting tables

FINITIONS | ACABADOS | FINISHES

STRUCTURE / ESTRUCTURA / FRAME | PLATEAU / SOBRE / DESK TOP

	060 Blanc Blanco White		064 Gris Grey		065 Hêtre Haya Beech		066 Chêne Moyen Roble Maple		067 Poirier Peral Pear
	068 Wengué Wengue Wengue		706 Acacia Clair Acacia Clara Light Acacia		707 Acacia Foncé Acacia Oscura Dark Acacia		020 Graphite Grafito Graphite		031 Chêne Veiné Castaño Claro Oak
	032 Chêne Grisê Castaño Oscuro Dark Oak color swatch								
	096 Blanc Blanco White		097 Gris Grey		098 Hêtre Haya Beech		099 Chêne Moyen Roble Maple		100 Poirier Peral Pear
	101 Wengué Wengue Wengue		709 Acacia Clair Acacia Clara Light Acacia		710 Acacia Foncé Acacia Oscura Dark Acacia		017 Graphite Grafito Graphite		166 Chêne Veiné Castaño Claro Oak
	167 Chêne Grisê Castaño Oscuro Dark Oak color swatch								
	163 Blanc Blanco White		180 Gris Grey		181 Hêtre Haya Beech		182 Chêne Moyen Roble Maple		183 Poirier Peral Pear
	184 Wengué Wengue Wengue		715 Acacia Clair Acacia Clara Light Acacia		716 Acacia Foncé Acacia Oscura Dark Acacia		113 Graphite Grafito Graphite		206 Chêne Veiné Castaño Claro Oak
	208 Chêne Grisê Castaño Oscuro Dark Oak color swatch								

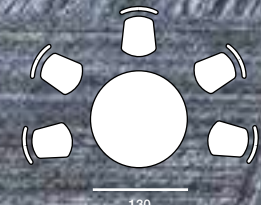

tono

Large éventail de styles et compositions
avec un minimum de références.

Con esta serie se obtiene una gran versatilidad
de estilos y composiciones
con un número reducido de referencias.

Great variety of styles and compositions within
the same range and easy to order.



PLATEAU / SOBRE / DESK TOP

Mélamine / Melamina / Melamine: 25 mm
Chant en ABS / Canto ABS / ABS edges

STRUCTURE / ESTRUCTURA / FRAME

Mélamine 2,5 / 1,9 cm
Melamina
Melamine 67,5 cm

HAUTEUR / ALTURA / HEIGHT

73 mm

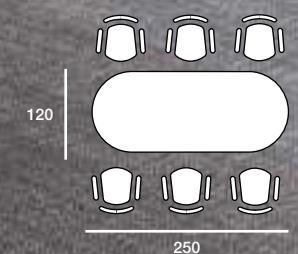

MODÈLES | VARIANTES | VERSIONS

MODÈLE / VARIANTES / VERSIONS	DIMENSIONS / MEDIDAS / MEASUREMENTS	RÉFÉRENCE / REFERENCIA / CODE
 <p>Table de réunion rectangulaire Mesa de reunión rectangular Rectangular meeting table</p>	250 x 120 cm 200 x 120 cm	604.001.-.- 604.002.-.-
 <p>Table de réunion ovale Mesa de reunión ovalada Oval meeting table</p>	250 x 120 cm 200 x 120 cm	604.003.-.- 604.004.-.-

FINITIONS | ACABADOS | FINISHES

STRUCTURE / ESTRUCTURA / FRAME | PLATEAU / SOBRE / DESK TOP

Argent Plata Silver	075	Blanc Blanco White	054	Gris Gris Grey	055	Hêtre Haya Beech	061	Chêne Moyen Roble Maple	062	Poirier Peral Pear
	116	Wengué Wengue Wengue	694	Acacia Clair Acacia Clara Light Acacia	695	Acacia Foncé Acacia Oscura Dark Acacia	115	Graphite Grafito Graphite	272	Chêne Veiné Castaño Claro Oak
	273	Chêne Grisé Castaño Oscuro Dark Oak								
Blanc Blanco White	081	Blanc Blanco White	076	Gris Gris Grey	077	Hêtre Haya Beech	078	Chêne Moyen Roble Maple	079	Poirier Peral Pear
	080	Wengué Wengue Wengue	168	Acacia Clair Acacia Clara Light Acacia	169	Acacia Foncé Acacia Oscura Dark Acacia	125	Graphite Grafito Graphite	043	Chêne Veiné Castaño Claro Oak
	106	Chêne Grisé Castaño Oscuro Dark Oak								

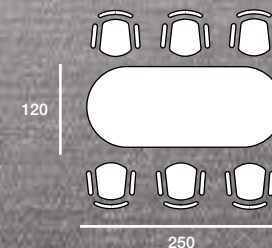

TAK

C'est une série de direction aux lignes droites et élégantes qui s'éloigne de tout ce qui est prétentieux.

Es una serie direccional que se armoniza para crear un sitio de trabajo funcional y práctico, de líneas rectas y puras en todo su conjunto.

TAK is a solid, straight lined and at the same time elegant looking executive range.

PLATEAU / SOBRE / DESK TOP

Mélamine / Melamina / Melamine: 40 mm

Chant en ABS / Canto ABS / ABS edges

STRUCTURE / ESTRUCTURA / FRAME

Mélamine / Melamina / Melamine: 40

FINITION STRUCTURE / ACABADO ESTRUCTURA / FRAME FINISH

Mélamine ou bois vernis
Melamina o madera barnizada
Melamine or wood veneer

HAUTEUR / ALTURA / HEIGHT

73 mm

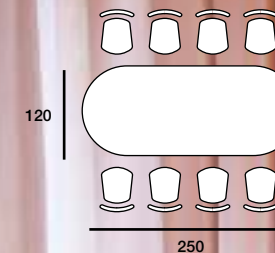

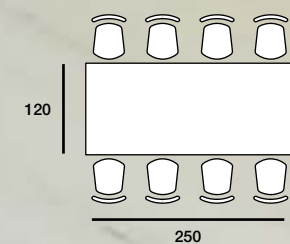

MODÈLES | VARIANTES | VERSIONS



MODÈLE / VARIANTES / VERSIONS	DIMENSIONS / MEDIDAS / MEASUREMENTS	RÉFÉRENCE / REFERENCIA / CODE	
	600 x 120 cm	Mélamine Melamina Melamine	Noyer Américain Nogal Americano American Walnut
	400 x 120 cm	564.202.-.-	564.702.365
	300 x 120 cm	564.208.-.-	564.708.365
	250 x 120 cm	564.214.-.-	564.714.365
	200 x 120 cm	564.216.-.-	564.716.365
	120 x 120 cm	564.218.-.-	564.718.365

Table de réunion rectangulaire
Mesa de reunión rectangular
Rectangular meeting table



	600 x 120 cm	Mélamine Melamina Melamine	Noyer Américain Nogal Americano American Walnut
	400 x 120 cm	564.102.-.-	564.402.365
	300 x 120 cm	564.108.-.-	564.408.365
	250 x 120 cm	564.114.-.-	564.414.365
	200 x 120 cm	564.116.-.-	564.416.365
	Ø 130 cm	564.118.-.-	564.418.365

Table de réunion ovale
Mesa de reunión ovalada
Oval meeting table

FINITIONS | ACABADOS | FINISHES

Monochrome Monocolor Single-colour	053	Blanc Blanco White	103	Acacia Clair Acacia Clara Light Acacia	104	Acacia Foncé Acacia Oscura Dark Acacia
	272	Chêne Veiné Castaño Claro Oak	273	Chêne Grisé Castaño Oscuro Dark Oak		Noyer Américain Nogal Americano American Walnut

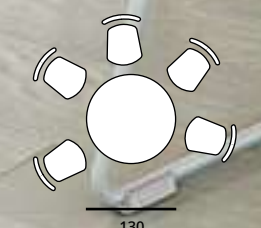

open

Les besoins actuels de nos centres de travail ont évolué techniquement afin de satisfaire et de s'adapter à notre époque.

Las necesidades actuales en los centros de trabajo han evolucionado técnicamente para satisfacer y adaptarse a estos tiempos.

Current needs at work places have technically developed in order to satisfy us and to adjust to our present time.

PLATEAU / SOBRE / DESK TOP

Stratifiés / Estratificado / Stratified: 40 mm

STRUCTURE / ESTRUCTURA / FRAME

Aluminium anodisé:
Aluminio anodizado:
Anodised aluminium:

110 x 30 mm



FINITION STRUCTURE / ACABADO ESTRUCTURA / FRAME FINISH

Peinture époxy
Pintura epoxi
Epoxy paint



Bain de chrome
Baño cromado
Chrome

HAUTEUR / ALTURA / HEIGHT

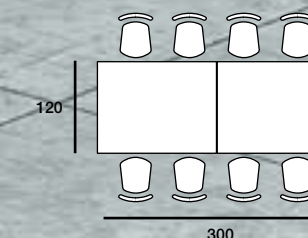
73 mm



MODÈLES | VARIANTES | VERSIONS

MODÈLE / VARIANTES / VERSIONS	DIMENSIONS / MEDIDAS / MEASUREMENTS	RÉFÉRENCE / REFERENCIA / CODE
	514 x 120 cm 436 x 120 cm 400 x 120 cm 350 x 120 cm 300 x 120 cm	344.104... 344.106... 344.108... 344.110... 344.112...
	240 x 120 cm 200 x 120 cm	344.114... 344.116...
	Ø 116 cm Ø 130 cm	344.194... 344.192...

Tables de réunion
Mesas de reunión
Meeting tables

FINITIONS | ACABADOS | FINISHES

STRUCTURE / ESTRUCTURA / FRAME | PLATEAU / SOBRE / DESK TOP

 Blanc Blanco White <small>RAL 9016</small>	 144 Blanc Blanco White	 145 Acacia Clair Acacia Clara Light Acacia	 146 Acacia Foncé Acacia Oscura Dark Acacia
 Chromée Cromado Chrome	 148 Blanc Blanco White	 149 Acacia Clair Acacia Clara Light Acacia	 150 Acacia Foncé Acacia Oscura Dark Acacia

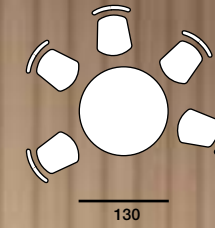

ROCK

Rock est synonyme de modernité et d'élégance. Cette série transmet une impression de légèreté, mais sa robustesse est garantie.

Elle se caractérise par sa colonne d'acier disponible en trois finitions.

Rock es sinónimo de modernidad y elegancia. Transmite una impresión de ligereza, pero su robustez esta asegurada técnicamente. Se caracteriza por su pie columna disponible en tres versiones de acabados.

Rock range is synonymous with modernity and elegance.

It conveys a light-weight image but has a strong and stable structure.

The stylised pole legs are the prevalent characteristic of this desk, available in three finishes.

PLATEAU / SOBRE / DESK TOP

Mélamine / Melamina / Melamine: 25 mm
Stratifié / Estratificado / Stratified: 25 mm

Chant en ABS / Canto ABS / ABS edges

STRUCTURE / ESTRUCTURA / FRAME

Acier: Ø75 mm
Steel:



FINITION STRUCTURE / ACABADO ESTRUCTURA / FRAME FINISH

Peinture époxy
Pintura epoxi
Epoxy paint

HAUTEUR / ALTURA / HEIGHT

70 mm

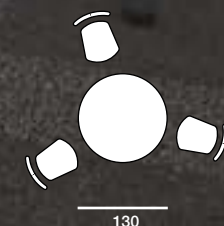



MODÈLES | VARIANTES | VERSIONS

MODÈLE / VARIANTES / VERSIONS	DIMENSIONS / MEDIDAS / MEASUREMENTS	RÉFÉRENCE / REFERENCIA / CODE
	600 x 120 cm	404.108. ---
	450 x 120 cm	404.112. ---
	300 x 120 cm	404.118. ---
	350 x 120 cm	404.116. ---
	400 x 120 cm	404.114. ---
	250 x 120 cm	404.120. ---
	200 x 120 cm	404.122. ---
	Ø 130 cm	404.130. ---
	Ø 116 cm	404.132. ---

Tables de réunion
Mesas de reunión
Meeting tables

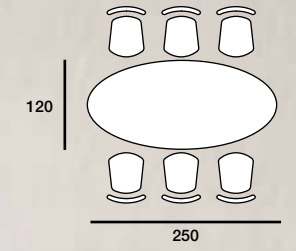

FINITIONS | ACABADOS | FINISHES

STRUCTURE / ESTRUCTURA / FRAME | PLATEAU / SOBRE / DESK TOP

 Argent Plata Silver RAL 9006	060 Blanc Blanco White	064 Gris Gris Grey	065 Hêtre Haya Beech	066 Chêne Moyen Roble Maple	067 Poirier Peral Pear	068 Wengué Wengue Wengue
	706 Acacia Clair Acacia Clara Light Acacia	707 Acacia Foncé Acacia Oscura Dark Acacia	020 Graphite Grafito Graphite	031 Chêne Veiné Castaño Claro Oak	032 Chêne Gris Castaño Oscuro Dark Oak	
 Blanc Blanco White RAL 9016	096 Blanc Blanco White	097 Gris Gris Grey	098 Hêtre Haya Beech	099 Chêne Moyen Roble Maple	100 Poirier Peral Pear	101 Wengué Wengue Wengue
	709 Acacia Clair Acacia Clara Light Acacia	710 Acacia Foncé Acacia Oscura Dark Acacia	017 Graphite Grafito Graphite	166 Chêne Veiné Castaño Claro Oak	167 Chêne Gris Castaño Oscuro Dark Oak	



ROL 1

Une série de tables de taille standard capables de s'adapter efficacement à de multiples espaces. Rol se caractérise par deux variantes importantes: table ronde et table carrée.

Una serie de mesas de medida estándar capaz de adaptarse eficazmente a múltiples espacios. Rol se caracteriza por disponer de dos variantes significativas: mesa redonda y cuadrada.

Rol standard-size tables capable of effectively adapting to multiple spaces. Rol is characterized by having two significant variants: round and square table, each of them also available as high or low.

PLATEAU / SOBRE / DESK TOP

Mélamine / Melamina / Melamine: 25 mm
Stratifié / Estratificado / Stratified: 25 mm

Chant en ABS / Canto ABS / ABS edges

STRUCTURE / ESTRUCTURA / FRAME

Acier: Ø114 mm
Steel:



114

FINITION STRUCTURE / ACABADO ESTRUCTURA / FRAME FINISH

Peinture époxy
Pintura epoxi
Epoxy paint

HAUTEUR / ALTURA / HEIGHT



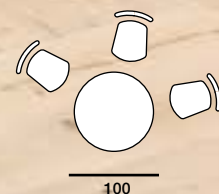



73 cm

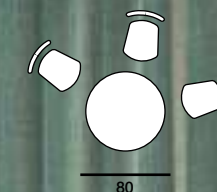

100

MODÈLES | VARIANTES | VERSIONS



MODÈLE / VARIANTES / VERSIONS	TYPE / TIPO / TYPE	DIMENSIONS / MEDIDAS / MEASUREMENTS	RÉFÉRENCE / REFERENCIA / CODE		
	Mixte / Mixta / Mixed	Ø100 cm Ø80 cm	 719.166...  719.167...	 719.266...  719.267...	 719.366...  719.367...

Tables de réunion
Mesas de reunión
Meeting tables

FINITIONS | ACABADOS | FINISHES

STRUCTURE / ESTRUCTURA / FRAME | PLATEAU / SOBRE / DESKTOP

 Argent Plata Silver RAL 9006	 053 Blanc Blanco White	 054 Gris Gris Grey	 055 Hêtre Haya Beech	 061 Chêne Moyen Roble Maple
 Blanc Blanco White RAL 9016	 062 Poirier Peral Pear	 116 Wengué Wengue Wengue	 103 Acacia Clair Acacia Clara Light Acacia	 104 Acacia Foncé Acacia Oscura Dark Acacia
 Graphite Grafito Graphite RAL 7022	 007 Graphite Grafito Graphite	 272 Chêne Veiné Castaño Claro Oak	 273 Chêne Gris Castaño Oscuro Dark Oak	



ROL 2

Une série de tables de taille standard capables de s'adapter efficacement à de multiples espaces. Rol se caractérise par deux variantes importantes: table ronde et table carrée.

Una serie de medida estándar capaz de adaptarse eficazmente a múltiples espacios. Rol se caracteriza por disponer de dos variantes significativas: mesa redonda y cuadrada.

Rol standard-size tables capable of effectively adapting to multiple spaces. Rol is characterized by having two significant variants: round and square table, each of them also available as high or low.

PLATEAUX / SOBRE / DESK TOP

Mélamine / Melamina / Melamine: 25 mm
Stratifié / Estratificado / Stratified: 25 mm

Chant en ABS / Canto ABS / ABS edges

STRUCTURE / ESTRUCTURA / FRAME

Acero: Ø114 mm
Steel:



FINITION STRUCTURE / ACABADO ESTRUCTURA / FRAME FINISH







Peinture époxy
Pintura epoxi
Epoxy paint

HAUTEUR / ALTURA / HEIGHT

73 cm



MODÈLES | VARIANTES | VERSIONS

MODÈLE / VARIANTES / VERSIONS	TYPE / TIPO / TYPE	DIMENSIONS / MEDIDAS / MEASUREMENTS	RÉFÉRENCE / REFERENCIA / CODE		
	Mixte / Mixta / Mixed	100 x 100 cm 80 x 80 cm	 719.186...  719.187...	 719.286...  719.287...	 719.386...  719.387...

Tables de réunion
Mesas de reunión
Meeting tables

FINITIONS | ACABADOS | FINISHES

STRUCTURE / ESTRUCTURA / FRAME | PLATEAU / SOBRE / DESKTOP

 Argent Plata Silver <small>RAL 9006</small>	 Blanc Blanco White <small>RAL 9016</small>	 Graphite Grafito Graphite <small>RAL 7022</small>	 053 Blanc Blanco White	 054 Gris Gris Grey	 055 Hêtre Haya Beech	 061 Chêne Moyen Roble Maple
	 062 Poirier Peral Pear	 116 Wengué Wengue Wengue	 103 Acacia Clair Acacia Clara Light Acacia	 104 Acacia Foncé Acacia Oscura Dark Acacia		
	 007 Graphite Grafito Graphite	 272 Chêne Veiné Castaño Claro Oak	 273 Chêne Grisé Castaño Oscuro Dark Oak			

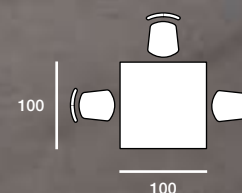

TABLES BASSES
MESAS DE CENTRO
COFFEE TABLES



264 | BROS



270 | ROCK 3



276 | SERIE 82



282 | TAK



288 | ROL

BROS

Cette table basse est la cerise sur le gâteau de la famille de chaises Bros. Sa forme organique en bois et métal apporte de la légèreté dans les salles d'attente, les réceptions et les sièges polyvalents.

Esta mesa de centro es la guinda del pastel de la familia de sillas Bros. Su forma orgánica compuesta en madera y metal aporta ligereza en salas de espera, recepciones y zonas polivalentes de soft seating.

This coffee table is very stylish and elegant due to the organic shape of its frame and the round edged top. It brings refinement to waiting rooms, receptions and multi-purpose soft seating areas.

PLATEAU / SOBRE / DESK TOP

Mélamine / Melamina / Melamine: 19 mm

Chant en ABS / Canto ABS / ABS edges

STRUCTURE / ESTRUCTURA / FRAME

Aceir: Ø15 mm
Acero:
Steel:



FINITION STRUCTURE / ACABADO ESTRUCTURA / FRAME FINISH

Peinture époxy
Pintura epoxi
Epoxy paint

HAUTEUR / ALTURA / HEIGHT

38,7 cm

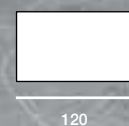

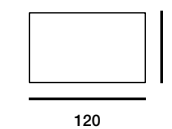
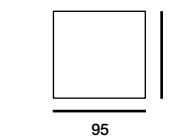
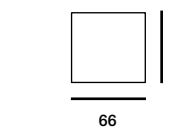
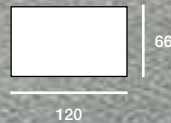

MODÈLES | VARIANTES | VERSIONS

STRUCTURE ACEIR / ESTRUCTURA ACERO / STEEL FRAME























MODÈLE / VARIANTES / VERSIONS	DIMENSIONS / MEDIDAS / MEASUREMENTS	RÉFÉRENCE / REFERENCIA / CODE
	66 x 66 cm	 57.041...  57.141...  57.241...  57.341...
	95 x 95 cm	57.042... 57.142... 57.242... 57.342...
	120 x 66 cm	57.040... 57.140... 57.240... 57.340...

Table basse
Mesa centro
Coffee table

FINITIONS | ACABADOS | FINISHES

STRUCTURE / ESTRUCTURA / FRAME | PLATEAU / SOBRE / DESKTOP

 Noir Negro Black RAL 9005	 053 Blanc Blanco White	 054 Gris Gris Grey	 055 Hêtre Haya Beech	 061 Chêne Moyen Roble Maple
 Blanc Blanco White RAL 9016	 062 Poirier Peral Pear	 116 Wengué Wengue Wengue	 103 Acacia Clair Acacia Clara Light Acacia	 104 Acacia Foncé Acacia Oscura Dark Acacia
 Argent Plata Silver RAL 9006	 007 Graphite Grafito Graphite	 272 Chêne Veiné Castaño Claro Oak	 273 Chêne Grisé Castaño Oscuro Dark Oak	 028 Noir Negro Black
 Graphite Grafito Graphite RAL 7022				



ROCK 3

Une version de ROCK 3 pour accompagner les espaces de sièges moelleux. Corp et prestance pour une table basse conforme aux normes.

Una versión de ROCK 3 para acompañar espacios de soft seating. Cuerpo y presencia para una mesa de centro que cumple con las normativas.

Rock 3 coffee table for soft seating spaces. Uncomplicated and no-nonsense design that complies with the regulations.

PLATEAU / SOBRE / DESK TOP

Mélamine / Melamina / Melamine: 25 mm

Chant en ABS / Canto ABS / ABS edges

STRUCTURE / ESTRUCTURA / FRAME

Mélamine / Melamina / Melamine

25

FINITION STRUCTURE / ACABADO ESTRUCTURA / FRAME FINISH

Mélamine
Melamina
Melamine

HAUTEUR / ALTURA / HEIGHT

35 cm



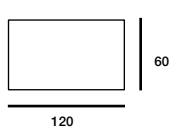
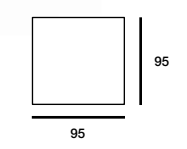
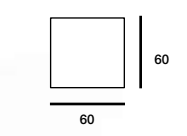
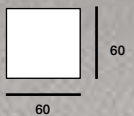

MODÈLES | VARIANTES | VERSIONS

STRUCTURE MÉLAMINE / ESTRUCTURA DE MELAMINA / MELAMINE FRAME



MODÈLE / VARIANTES / VERSIONS	DIMENSIONS / MEDIDAS / MEASUREMENTS	RÉFÉRENCE / REFERENCIA / CODE
	60 x 60 cm	431.317.-..
	95 x 95 cm	431.316.-..
	120 x 60 cm	431.315.-..

Table basse
Mesa centro
Coffee table

FINITIONS | ACABADOS | FINISHES

053	Blanc Blanco White	054	Gris Gris Grey	055	Hêtre Haya Beech	061	Chêne Moyen Roble Maple	062	Poirier Peral Pear
116	Wengué Wengue Wengue	103	Acacia Clair Acacia Clara Light Acacia	104	Acacia Foncé Acacia Oscura Dark Acacia	007	Graphite Grafito Graphite	272	Chêne Veiné Castaño Claro Oak
273	Chêne Gris Castaño Oscuro Dark Oak								

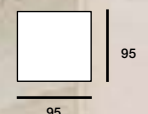

SERIE 82

La série 82, est une table basse classique pour équiper tous les espaces. Sa structure avec des courbes lui donne un caractère léger et simple.

Serie 82, es una mesa de centro clásica con la que equipar todo tipo de espacios. Su estructura en curva le concede un carácter ligero y sencillo.

Series 82 is a classic coffee table with which to equip waiting rooms or soft seating areas. Its curved structure gives it a vintage and mature character.

PLATEAU / SOBRE / DESK TOP

Mélamine / Melamina / Melamine: 19 mm

Chant en ABS / Canto ABS / ABS edges

STRUCTURE / ESTRUCTURA / FRAME

Acier: 30 x 15 mm
Steel:



FINITION STRUCTURE / ACABADO ESTRUCTURA / FRAME FINISH

Peinture époxy
Pintura epoxi
Epoxy paint

HAUTEUR / ALTURA / HEIGHT

39 cm



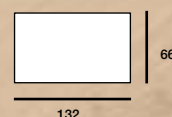
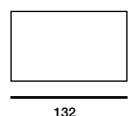
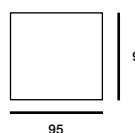
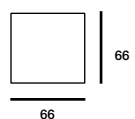

MODÈLES | VARIANTES | VERSIONS

STRUCTURE ACEIR / ESTRUCTURA ACERO / STEEL FRAME





MODÈLE / VARIANTES / VERSIONS	DIMENSIONS / MEDIDAS / MEASUREMENTS	RÉFÉRENCE / REFERENCIA / CODE	
	66 x 66 cm	 82.910.-.-	 82.920.-.-
	95 x 95 cm	82.950.-.-	82.960.-.-
	132 x 66 cm	82.930.-.-	82.940.-.-

Table basse
Mesa centro
Coffee table

FINITIONS | ACABADOS | FINISHES

STRUCTURE / ESTRUCTURA / FRAME | PLATEAU / SOBRE / DESKTOP

 Noir Negro Black <small>RAL 9005</small>	 054 Gris Gris Grey	 055 Hêtre Haya Beech	 061 Chêne Moyen Roble Maple	 062 Poirier Peral Pear
 Chromée Cromado Chrome	 007 Graphite Grafito Graphite	 116 Wengué Wengue Wengue	 103 Acacia Clair Acacia Clara Light Acacia	 104 Acacia Foncé Acacia Oscura Dark Acacia
	 272 Chêne Veiné Castaño Claro Oak	 273 Chêne Grisé Castaño Oscuro Dark Oak		

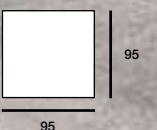
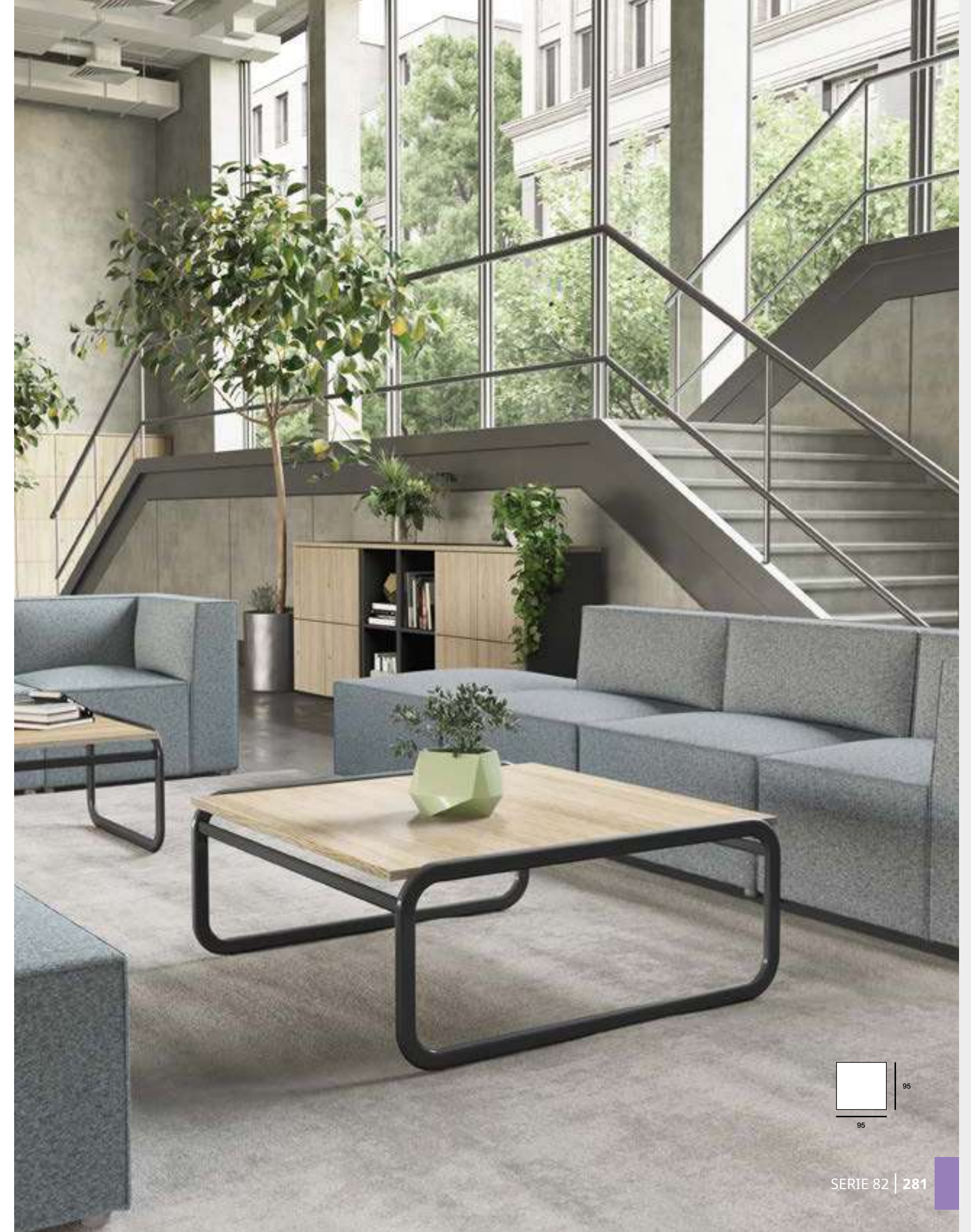

TAK

Une réplique en petit mais tout aussi sobre. Ses lignes droites et l'épaisseur de ses matériaux mettent en valeur les espaces dans lesquels il est présenté. Les finitions métalliques qui séparent la structure du plateau ajoutent de l'air et rehaussent son design.

Una réplica en pequeño pero igual de sobria. Sus líneas rectas y el grosor de su cuerpo realzan los espacios en los que se presenta. Los acabados metálicos que separan la estructura del sobre aportan aire y elevan su diseño.

A replica of the executive desk but in small. Its straight lines and the solidity of its body magnifies the space in which it is placed. The chrome details that separate the panels from the top provides quality and prestige.

PLATEAU / SOBRE / DESK TOP

Mélamine / Melamina / Melamine: 40 mm

Chant en ABS / Canto ABS / ABS edges

STRUCTURE / ESTRUCTURA / FRAME

Mélamine / Melamina / Melamine:

40

FINITION STRUCTURE / ACABADO ESTRUCTURA / FRAME FINISH

Mélamine ou bois vernis
Melamina o madera barnizada
Melamine or wood veneer

HAUTEUR / ALTURA / HEIGHT

40,2 cm



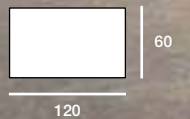
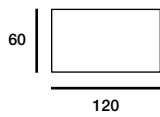
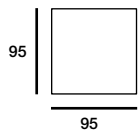
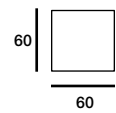

MODÈLES | VARIANTES | VERSIONS



MODÈLE / VARIANTES / VERSIONS	DIMENSIONS / MEDIDAS / MEASUREMENTS	RÉFÉRENCE / REFERENCIA / CODE
	60 x 60 cm	Mélamine / Melamina / Melamine Noyer Américain / Nogal Americano / American Walnut 561.116... 561.416.365
	95 x 95 cm	561.117... 561.417.365
	120 x 60 cm	561.115... 561.415.365

Table basse
Mesa centro
Coffee table

FINITIONS | ACABADOS | FINISHES

Monochrome
Monocolor
Single-colour

053	Blanc Blanco White	103	Acacia Clair Acacia Clara Light Acacia	104	Acacia Foncé Acacia Oscura Dark Acacia	272	Chêne Veiné Castaño Claro Oak
273	Chêne Grisé Castaño Oscuro Dark Oak		Noyer Américain Nogal Americano American Walnut				



ROL

La simplicité de cette table basse transforme les pauses et les réunions informelles en rencontres dynamiques, collaboratives et efficaces.

La simplicidad desenfadada de esta mesa de centro convierte los descansos y las reuniones informales en encuentros dinámicos, colaborativos y efectivos.

The simplicity of this round coffee table turns breaks and informal meetings into relaxed and easygoing encounters.

PLATEAU / SOBRE / DESK TOP

Mélamine / Melamina / Melamine: 25 mm
Stratifié / Estratificado / Stratified: 25 mm

Chant en ABS / Canto ABS / ABS edges

STRUCTURE / ESTRUCTURA / FRAME

Acier: Ø114 mm
Steel:



114

FINITION STRUCTURE / ACABADO ESTRUCTURA / FRAME FINISH

Peinture époxy
Pintura epoxi
Epoxy paint

HAUTEUR / ALTURA / HEIGHT

44,5 cm
45 cm



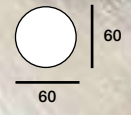
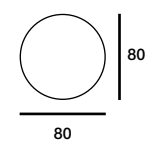
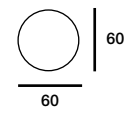

MODÈLES | VARIANTES | VERSIONS

STRUCTURE ACEIR / ESTRUCTURA ACERO / STEEL FRAME

MODÈLE / VARIANTES / VERSIONS	DIMENSIONS / MEDIDAS / MEASUREMENTS		RÉFÉRENCE / REFERENCIA / CODE		
	H 44,5 cm	Ø80 cm	719.159.-..	719.259.-..	719.359.-..
	H 45 cm	Ø60 cm	719.168.-..	719.268.-..	719.368.-..

Table basse
Mesa centro
Coffee table

FINITIONS | ACABADOS | FINISHES

STRUCTURE / ESTRUCTURA / FRAME | PLATEAU / SOBRE / DESKTOP

Argent Plata Silver RAL 9006	Blanc Blanco White RAL 9016	Gris Gris Grey	Hêtre Haya Beech	Chêne Moyen Roble Maple
Blanc Blanco White RAL 9016	Poirier Peral Pear	Wengué Wengue Wengue	Acacia Clair Acacia Clara Light Acacia	Acacia Foncé Acacia Oscura Dark Acacia
Graphite Grafito Graphite RAL 7022	Chêne Veiné Castaño Claro Oak	Chêne Grisé Castaño Oscuro Dark Oak		



CLOISONS
MAMPARAS
SCREENS



296 | RB



308 | CALL



318 | ROCK SYSTEMS



326 | NEKTA

RB

RB est une série de cloisons modulaires qui favorise l'organisation et la définition des espaces de travail et qui s'adapte aux défis de la vie quotidienne. Il se présente comme une solution organisatrice et génératrice capable de créer un équilibre entre différents espaces, avec plus ou moins d'intimité.

RB es una serie de mamparas modulares que favorece la organización y la definición de los espacios de trabajo adecuándose a los retos del día a día. Se presenta como una solución organizadora y generadora de ambientes capaz de crear equilibrio entre distintos espacios, con mayor o menor nivel de privacidad.

RB is an innovative office partition system that helps to divide workplaces in a flexible and ingenious way. RB partitions have an attractive framework that can be integrated into all furniture ranges and build areas that simplify people teamwork. Contribute to business results by taking care of workers in a peaceful company.

FINITION CLOISONS / ACABADOS MAMPARA / SCREEN FINISHES

Mélamine / Melamina / Melamine
Tissu / Tapizado / Upholstered
Acoustique / Acústico / Acoustic

HAUTEUR / ALTURA / HEIGHT

Fixe:
Fija: 41'5, 73, 81, 120, 158, 196, 235 cm
Fixed:

MODULES AVEC
DIFFÉRENTES
HAUTEURS

COMPOSICIÓN
DE DIFERENTES
ALTURAS

DIFFERENT
HEIGHTS
COMPOSITION

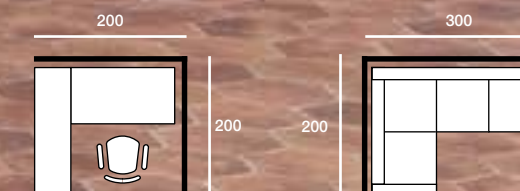



| MULTI PANNEAUX

| MULTIPANEL

| TILED

Ensemble de cloisons droites.
 Conjunto de mamparas rectas.
 Straight screens set.

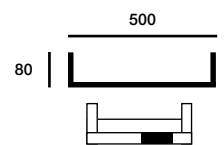

| UN SEUL PANNEAU

| MONOPANEL

| MONOLITHIC

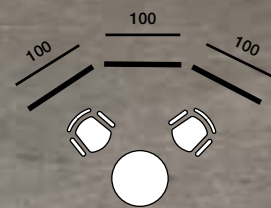

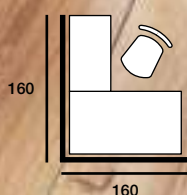

Accessoires en PET.
Complementos de PET.
PET accessories.



Ardoise magnétique blanche.
Pizarra magnética blanca.
White magnetic board.



Compléments en mélamine, étagères suspendues.
Complementos de melamina, estantes.
Melamine accessories, shelves.

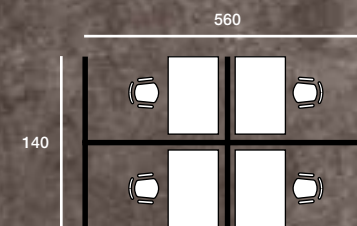
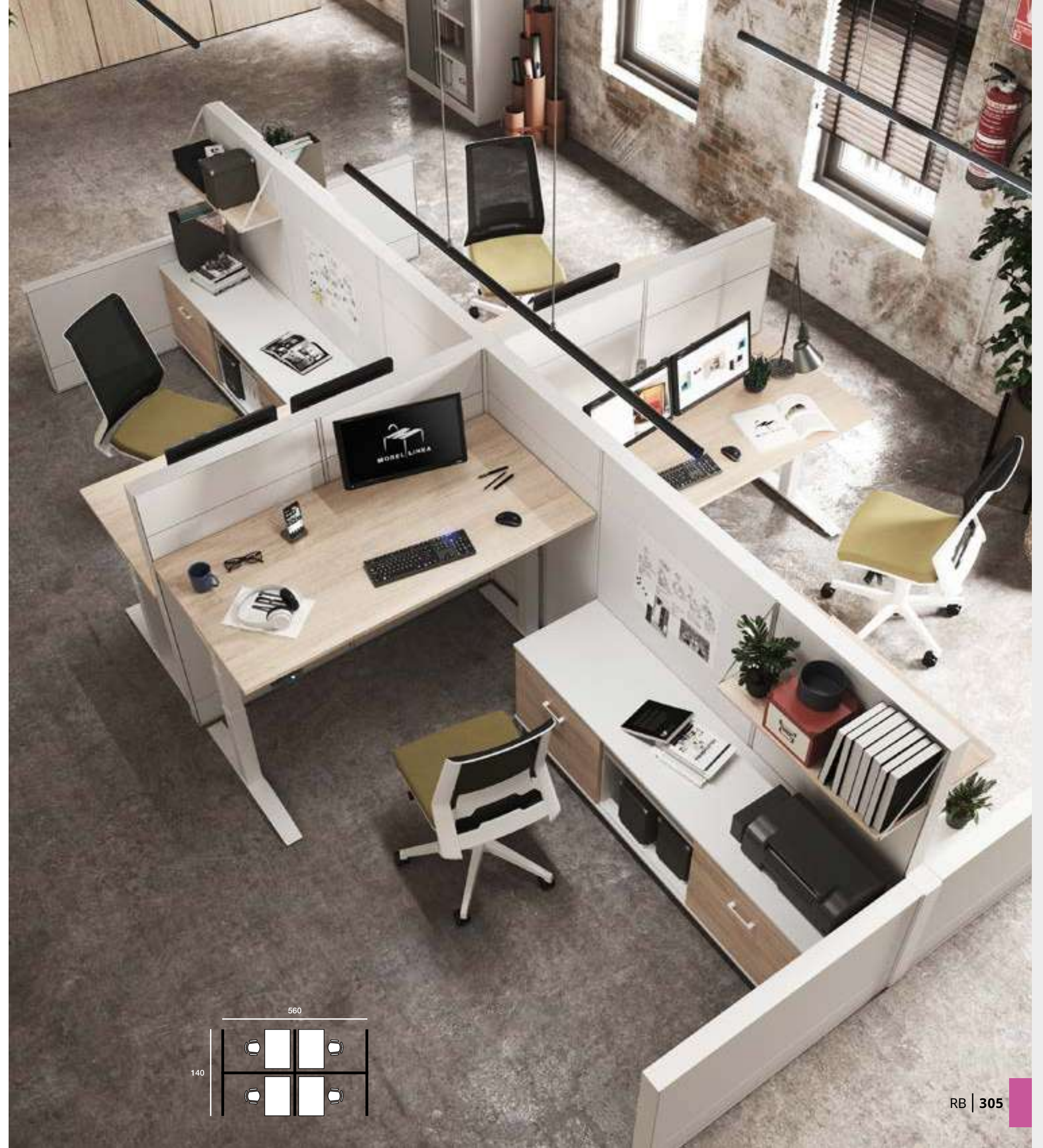

Compléments métalliques, penderie.
Complementos metálicos, perchero.
Metal accessories, coat-bar.



call

Cette série, très adaptée pour l'aménagement des centres d'appels, est très fonctionnelle et optimise l'espace de travail au maximum en apportant confort et commodité à l'utilisateur.

Representa la optimización del espacio de trabajo. Con unos conceptos de funcionalidad que permiten al usuario gestionar de forma eficaz su confort en su puesto de trabajo.

It represents the optimization in working spaces. Thanks to its functionality concept, users will be able to manage more efficiently their working places.

PLATEAU / SOBRE / DESK TOP

Mélamine / Melamina / Melamine: 25 mm

FINITION CLOISONS / ACABADOS MAMPARA / SCREEN FINISHES

Mélamine / Melamina / Melamine
Tissu / Tapizado / Upholstered
Acoustique / Acústico / Acoustic
Méthacrylate / Metacrilato / Methacrylate

HAUTEUR / ALTURA / HEIGHT

Table:	Cloisons:
Mesa: 73 cm	Paneles: 121 - 140 cm
Desk:	Screens:

INDIVIDUEL
OU ALIGNÉ

INDIVIDUAL
O EN LÍNEA

SINGLE OR
SIDE BY SIDE

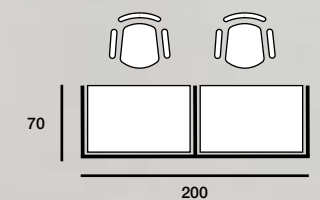

| MARGUERITES

| MARGARITAS

| CLUSTERS

Acoustique
Acústico
Acoustic



| DOUBLE

| DOBLE

| FACE TO FACE

Les cloisonnettes acoustiques vous aideront à contrôler le bruit excessif.
Con los plafones separadores acústicos se reduce el nivel de ruido.
Acoustic panels help to reduce the noise of the room.

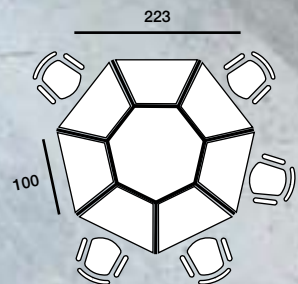
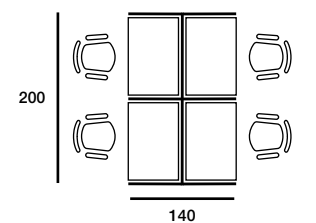

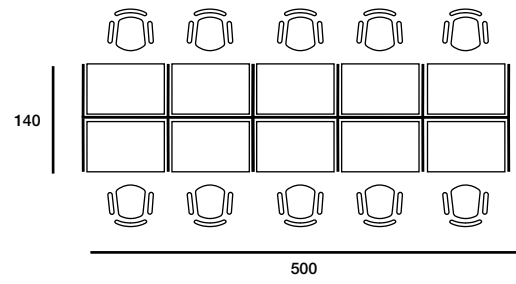





| DOUBLE

| DOBLE

| FACE TO FACE



MODÈLES | VARIANTES | VERSIONS

MODÈLE / VARIANTES / VERSIONS	TYPE / TIPO / TYPE	DIMENSIONS / MEDIDAS / MEASUREMENTS	RÉFÉRENCE / REFERENCIA / CODE	
	Modules: / Módulos de: / Moduls of:		19mm	25mm
	H.120 cm	100 x 70 cm 80 x 70 cm	807.314.-.- 807.315.-.-	807.214.-.- 807.215.-.-
Individual terminal Individual terminal Single start unit	H.140 cm	100 x 70 cm 80 x 70 cm	807.304.-.- 807.305.-.-	807.204.-.- 807.205.-.-
	H.120 cm	100 x 70 cm 80 x 70 cm	807.334.-.- 807.335.-.-	807.234.-.- 807.235.-.-
	H.140 cm	100 x 70 cm 80 x 70 cm	807.324.-.- 807.325.-.-	807.224.-.- 807.225.-.-
	H.120 cm	100 x 70 cm 80 x 70 cm	807.334.-.- 807.335.-.-	807.234.-.- 807.235.-.-
Individual central Individual central Single add-on unit	H.140 cm	100 x 70 cm 80 x 70 cm	807.324.-.- 807.325.-.-	807.224.-.- 807.225.-.-
	H.120 cm	100 x 140 cm 80 x 140 cm	807.364.-.- 807.365.-.-	807.264.-.- 807.265.-.-
	H.140 cm	100 x 140 cm 80 x 140 cm	807.354.-.- 807.355.-.-	807.254.-.- 807.255.-.-
	H.120 cm	100 x 140 cm 80 x 140 cm	807.364.-.- 807.365.-.-	807.264.-.- 807.265.-.-
En vis à vis terminal Enfrentados terminal Face to face start unit	H.140 cm	100 x 140 cm 80 x 140 cm	807.354.-.- 807.355.-.-	807.254.-.- 807.255.-.-
	H.120 cm	100 x 140 cm 80 x 140 cm	807.384.-.- 807.385.-.-	807.284.-.- 807.285.-.-
	H.140 cm	100 x 140 cm 80 x 140 cm	807.374.-.- 807.375.-.-	807.274.-.- 807.275.-.-
	H.120 cm	100 x 140 cm 80 x 140 cm	807.384.-.- 807.385.-.-	807.284.-.- 807.285.-.-
En vis à vis central Enfrentados central Face to face add-on unit	H.140 cm	1400 x 70 + 100 cm 1400 x 70 + 80 cm	807.356.-.- 807.357.-.-	807.256.-.- 807.257.-.-
	H.120 cm	1400 x 70 + 100 cm 1400 x 70 + 80 cm	807.366.-.- 807.367.-.-	807.266.-.- 807.267.-.-
	H.140 cm	1400 x 70 + 100 cm 1400 x 70 + 80 cm	807.356.-.- 807.357.-.-	807.256.-.- 807.257.-.-
	H.120 cm	1400 x 70 + 100 cm 1400 x 70 + 80 cm	807.366.-.- 807.367.-.-	807.266.-.- 807.267.-.-
En vis à vis avec superviseur Enfrentados con supervisor Face to face with supervisor	H.140 cm	100 X 157 cm 100 X 157 cm	807.404.-.- 807.403.-.-	807.404.-.- 807.403.-.-
	H.120 cm	100 X 157 cm 100 X 157 cm	807.408.-.- 807.407.-.-	807.408.-.- 807.407.-.-

Marguerite
Margarita
Cluster

FINITIONS ACABADOS FINISHES





096	Blanc Blanco White	064	Gris Gris Grey	065	Hêtre Haya Beech	113	Graphite Grafito Graphite
066	Chêne Moyen Roble Maple	067	Poirier Peral Pear	068	Wengué Wengue Wengue	095	Argent Plata Silver
706	Acacia Clair Acacia Clara Light Acacia	707	Acacia Foncé Acacia Oscura Dark Acacia	272	Chêne Veiné Castaño Claro Oak	273	Chêne Grisé Castaño Oscuro Dark Oak

FINITIONS | ACABADOS | FINISHES

CLOISONS / MAMPARA / SCREEN | PLATEAU / SOBRE / DESK TOP

Mélamine Melamina Melamine	053	Blanc Blanco White	054	Gris Gris Grey	055	Hêtre Haya Beech	061	Chêne Moyen Roble Maple	062	Poirier Peral Pear	116	Wengué Wengue Wengue
	103	Acacia Clair Acacia Clara Light Acacia	104	Acacia Foncé Acacia Oscura Dark Acacia	007	Graphite Grafito Graphite	051	Argent Plata Silver	272	Chêne Veiné Castaño Claro Oak	273	Chêne Grisé Castaño Oscuro Dark Oak

MODÈLES | VARIANTES | VERSIONS

MODÈLE / VARIANTES / VERSIONS	TYPE / TIPO / TYPE	DIMENSIONS / MEDIDAS / MEASUREMENTS	RÉFÉRENCE / REFERENCIA / CODE	
	Modules: / Módulos de: / Moduls of:		19mm	25mm
	H.120 cm	100 x 70 cm 80 x 70 cm	807.214.-.- 807.215.-.-	807.214.-.- 807.215.-.-
Individual terminal Individual terminal Single start unit	H.140 cm	100 x 70 cm 80 x 70 cm	807.204.-.- 807.205.-.-	807.204.-.- 807.205.-.-
	H.120 cm	100 x 70 cm 80 x 70 cm	807.234.-.- 807.235.-.-	807.234.-.- 807.235.-.-
	H.140 cm	100 x 70 cm 80 x 70 cm	807.224.-.- 807.225.-.-	807.224.-.- 807.225.-.-
	H.120 cm	100 x 70 cm 80 x 70 cm	807.234.-.- 807.235.-.-	807.234.-.- 807.235.-.-
Individual central Individual central Single add-on unit	H.140 cm	100 x 70 cm 80 x 70 cm	807.224.-.- 807.225.-.-	807.224.-.- 807.225.-.-
	H.120 cm	100 x 140 cm 80 x 140 cm	807.264.-.- 807.265.-.-	807.264.-.- 807.265.-.-
	H.140 cm	100 x 140 cm 80 x 140 cm	807.254.-.- 807.255.-.-	807.254.-.- 807.255.-.-
	H.120 cm	100 x 140 cm 80 x 140 cm	807.264.-.- 807.265.-.-	807.264.-.- 807.265.-.-
En vis à vis terminal Enfrentados terminal Face to face start unit	H.140 cm	100 x 140 cm 80 x 140 cm	807.254.-.- 807.255.-.-	807.254.-.- 807.255.-.-
	H.120 cm	100 x 140 cm 80 x 140 cm	807.284.-.- 807.285.-.-	807.284.-.- 807.285.-.-
	H.140 cm	100 x 140 cm 80 x 140 cm	807.274.-.- 807.275.-.-	807.274.-.- 807.275.-.-
	H.120 cm	100 x 140 cm 80 x 140 cm	807.284.-.- 807.285.-.-	807.284.-.- 807.285.-.-
En vis à vis central Enfrentados central Face to face add-on unit	H.140 cm	1400 x 70 + 100 cm 1400 x 70 + 80 cm	807.256.-.- 807.257.-.-	807.256.-.- 807.257.-.-
	H.120 cm	1400 x 70 + 100 cm 1400 x 70 + 80 cm	807.266.-.- 807.267.-.-	807.266.-.- 807.267.-.-
	H.140 cm	1400 x 70 + 100 cm 1400 x 70 + 80 cm	807.256.-.- 807.257.-.-	807.256.-.- 807.257.-.-
	H.120 cm	1400 x 70 + 100 cm 1400 x 70 + 80 cm	807.266.-.- 807.267.-.-	807.266.-.- 807.267.-.-
En vis à vis avec superviseur Enfrentados con supervisor Face to face with supervisor	H.140 cm	100 X 157 cm 100 X 157 cm	807.404.-.- 807.403.-.-	807.404.-.- 807.403.-.-
	H.120 cm	100 X 157 cm 100 X 157 cm	807.408.-.- 807.407.-.-	807.408.-.- 807.407.-.-

Marguerite
Margarita
Cluster

FINITIONS ACABADOS FINISHES

818	Blanc Blanco White	819	Gris Gris Grey	820	Hêtre Haya Beech	816	Graphite Grafito Graphite
821	Chêne Moyen Roble Maple	822	Poirier Peral Pear	823	Wengué Wengue Wengue	817	Argent Plata Silver
824	Acacia Clair Acacia Clara Light Acacia	825	Acacia Foncé Acacia Oscura Dark Acacia	025	Chêne Veiné Castaño Claro Oak	026	Chêne Grisé Castaño Oscuro Dark Oak

FINITIONS | ACABADOS | FINISHES







CLOISONS / MAMPARA / SCREEN | PLATEAU / SOBRE / DESK TOP

Acoustique / Mélamine Acústico / Melamina Acoustic / Melamine	792	Blanc Blanco White	799	Gris Gris Grey	802	Hêtre Haya Beech	803	Chêne Moyen Roble Maple	811	Poirier Peral Pear	812	Wengué Wengue Wengue
	813	Acacia Clair Acacia Clara Light Acacia	814	Acacia Foncé Acacia Oscura Dark Acacia	790	Graphite Grafito Graphite	791	Argent Plata Silver	025	Chêne Veiné Castaño Claro Oak	026	Chêne Grisé Castaño Oscuro Dark Oak

Cf. page 464
Ver pagina 464
See page 464

Cf. page 464
Ver pagina 464
See page 464

MODÈLES | VARIANTES | VERSIONS

MODÈLE / VARIANTES / VERSIONS	TYPE / TIPO / TYPE	DIMENSIONS / MEDIDAS / MEASUREMENTS	RÉFÉRENCE / REFERENCIA / CODE
 Individuel terminal Individual terminal Single start unit	Modules: / Módulos de: / Moduls of: H.120 cm	100 x 70 cm 80 x 70 cm	19mm 25mm 807.214.-.- 807.215.-.-
	H.140 cm	100 x 70 cm 80 x 70 cm	807.204.-.- 807.205.-.-
 Individuel central Individual central Single add-on unit	H.120 cm	100 x 70 cm 80 x 70 cm	807.234.-.- 807.235.-.-
	H.140 cm	100 x 70 cm 80 x 70 cm	807.224.-.- 807.225.-.-
 En vis à vis terminal Enfrentados terminal Face to face start unit	H.120 cm	100 x 140 cm 80 x 140 cm	807.264.-.- 807.265.-.-
	H.140 cm	100 x 140 cm 80 x 140 cm	807.254.-.- 807.255.-.-
 En vis à vis central Enfrentados central Face to face add-on unit	H.120 cm	100 x 140 cm 80 x 140 cm	807.284.-.- 807.285.-.-
	H.140 cm	100 x 140 cm 80 x 140 cm	807.274.-.- 807.275.-.-
 En vis à vis avec superviseur Enfrentados con supervisor Face to face with supervisor	H.120 cm	1400 x 70 + 100 cm 1400 x 70 + 80 cm	807.266.-.- 807.267.-.-
	H.140 cm	1400 x 70 + 100 cm 1400 x 70 + 80 cm	807.256.-.- 807.257.-.-
 Marguerite Margarita Cluster	5P: H.120 cm H.140 cm	100 X 157 cm 100 X 157 cm	807.408.-.- 807.407.-.-
	7P: H.120 cm H.140 cm	100 X 157 cm 100 X 157 cm	807.404.-.- 807.403.-.-

FINITIONS ACABADOS FINISHES

450 Blanc Blanco White	456 Gris Gris Grey	457 Hêtre Haya Beech	448 Graphite Grafito Graphite
458 Chêne Moyen Roble Maple	459 Poirier Peral Pear	492 Wengué Wengue Wengue	449 Argent Plata Silver
493 Acacia Clair Acacia Clara Light Acacia	494 Acacia Foncé Acacia Oscura Dark Acacia	025 Chêne Veiné Castaño Claro Oak	026 Chêne Grisé Castaño Oscuro Dark Oak



Cf. page 464
Ver pagina 464
See page 464

FINITIONS | ACABADOS | FINISHES





CLOISONS / MAMPARA / SCREEN | PLATEAU / SOBRE / DESK TOP

Mélanges / Tissue Melamina / Tapizado Melamine / Upholstered	002 Blanc Blanco White	010 Gris Gris Grey	011 Hêtre Haya Beech	012 Chêne Moyen Roble Maple	013 Poirier Peral Pear	019 Wengué Wengue Wengue
	703 Acacia Clair Acacia Clara Light Acacia	704 Acacia Foncé Acacia Oscura Dark Acacia	004 Graphite Grafito Graphite	006 Argent Plata Silver	025 Chêne Veiné Castaño Claro Oak	026 Chêne Grisé Castaño Oscuro Dark Oak



Cf. page 464
Ver pagina 464
See page 464

MODÈLES | VARIANTES | VERSIONS

MODÈLE / VARIANTES / VERSIONS	TYPE / TIPO / TYPE	DIMENSIONS / MEDIDAS / MEASUREMENTS	RÉFÉRENCE / REFERENCIA / CODE
 Individuel terminal Individual terminal Single start unit	Modules: / Módulos de: / Moduls of: H.120 cm	100 x 70 cm 80 x 70 cm	25mm 807.214.-.- 807.215.-.-
	H.140 cm	100 x 70 cm 80 x 70 cm	807.204.-.- 807.205.-.-
 Individuel central Individual central Single add-on unit	H.120 cm	100 x 70 cm 80 x 70 cm	807.234.-.- 807.235.-.-
	H.140 cm	100 x 70 cm 80 x 70 cm	807.224.-.- 807.225.-.-
 En vis à vis terminal Enfrentados terminal Face to face start unit	H.120 cm	100 x 140 cm 80 x 140 cm	807.264.-.- 807.265.-.-
	H.140 cm	100 x 140 cm 80 x 140 cm	807.254.-.- 807.255.-.-
 En vis à vis central Enfrentados central Face to face add-on unit	H.120 cm	100 x 140 cm 80 x 140 cm	807.284.-.- 807.285.-.-
	H.140 cm	100 x 140 cm 80 x 140 cm	807.274.-.- 807.275.-.-
 En vis à vis avec superviseur Enfrentados con supervisor Face to face with supervisor	H.120 cm	1400 x 70 + 100 cm 1400 x 70 + 80 cm	807.266.-.- 807.267.-.-
	H.140 cm	1400 x 70 + 100 cm 1400 x 70 + 80 cm	807.256.-.- 807.257.-.-

FINITIONS | ACABADOS | FINISHES

CLOISONS / MAMPARA / SCREEN | PLATEAU / SOBRE / DESK TOP

Méthacrylate transp. / Mélanges Met. Transparente / Melamina Clear methacrylate / Melamine	413 Blanc Blanco White	414 Gris Gris Grey	415 Hêtre Haya Beech	416 Chêne Moyen Roble Maple	417 Poirier Peral Pear	418 Wengué Wengue Wengue
	626 Acacia Clair Acacia Clara Light Acacia	627 Acacia Foncé Acacia Oscura Dark Acacia	408 Graphite Grafito Graphite	409 Argent Plata Silver	892 Chêne Veiné Castaño Claro Oak	893 Chêne Grisé Castaño Oscuro Dark Oak

ROCK SYSTEMS

ROCK SYSTEMS est une gamme de cloisons modulaires qui permet de créer des espaces de travail dynamiques et confortables.

ROCK SYSTEMS es una serie de mamparas diseñadas para crear espacios de trabajo dinámicos. Con distintas formas y acabados se podrá aislar cualquier espacio manteniendo el estilo de las oficinas.

ROCK SYSTEMS is a furniture screen range. Designed with modular elements that can be combined to create an optimum, comfortable and visually appealing space.

PLATEAU / SOBRE / DESK TOP

Agglomérer / Aglomerado / Chipboard 25 mm

FINITION STRUCTURE / ACABADO ESTRUCTURA / FRAME FINISH

Aluminium
Aluminio
Aluminum

FINITION CLOISONS / ACABADOS MAMPARA / SCREEN FINISHES

Mélamine / Melamina / Melamine
Tissu / Tapizado / Upholstered
Méthacrylate / Metacrilato / Methacrylate

HAUTEUR / ALTURA / HEIGHT

Fixe:
Fija: 101, 140, 178 cm
Fixed:

ENSEMBLE
DE CLOISONS
DROITES

CONJUNTO
DE MAMPARAS
RECTAS

STRAIGHT
SCREENS
SET

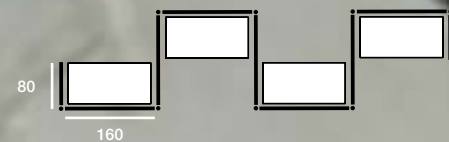

CLOISONS
MONOPANNEAU

MAMPARAS RECTAS
MONO PANEL

SINGLE PANEL
STRAIGHT SCREENS

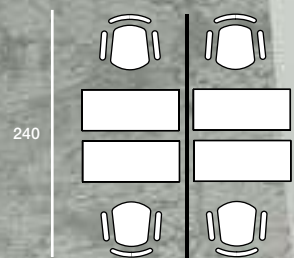

UNION CIRCULAIRE
ENTRE 3
CLOISONS

UNIÓN CIRCULAR
ENTRE 3
MAMPARAS

3 SCREENS
SET



CLOISONS
MULTI-PANNEAUX

MAMPARAS RECTAS
MULTIPANEL

MULTIPANEL
STRAIGHT SCREENS

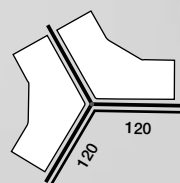

Unions entre 2, 3 ou 4 cloisons.
Uniones de 2, 3 o 4 mamparas.
Joining fittings of 2, 3 or 4 screens.

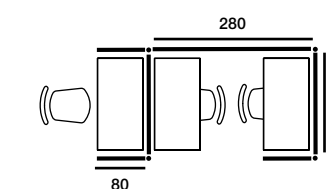

CLOISONS QUART
DE CERCLE

MAMPARAS
CURVADAS 90°

CURVED
SCREENS

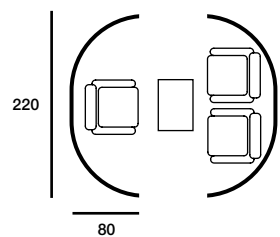

NEKTA

Ligne de cloisons en méthacrylate transparent pour protéger et garantir la sécurité et la santé des gens sans perdre l'essence et le climat du travail collaboratif.

Línea de mamparas de metacrilato transparente para proteger y garantizar la seguridad y la salud de las personas sin perder la esencia y el clima del trabajo colaborativo.

Line of transparent methacrylate screens to protect and guarantee the safety and health preserving the nature and ambience of working together.

| INDIVIDUEL

| INDIVIDUAL

| SINGLE



ÉCRAN / MAMPARA / SCREEN

Méthacrylate / Metacrilato / Methacrylate: 3-6 mm

FINITION CLOISONS / ACABADOS MAMPARA / SCREEN FINISHES

Mét. Transparent / Met. Transparente / Clear methacrylate

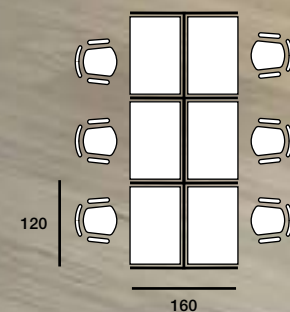



| ÉCRAN POUR CLOISONNETTE

| MAMPARA PARA PLAFÓN SEPARADOR

| PROTECTION FOR FRONT SCREEN

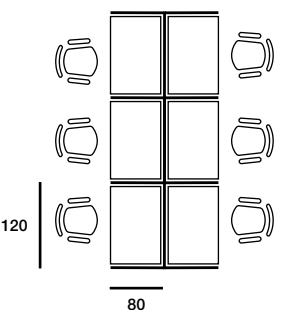

ÉCRAN AVEC
FENTE

MAMPARAS CON
ATENCIÓN AL
CLIENTE

SCREENS FOR
CUSTOMER
SERVICE

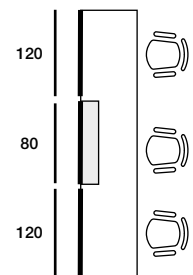



| POUR LUMINAIRES

| PARA LUMINARIAS

| FOR LIGHTING

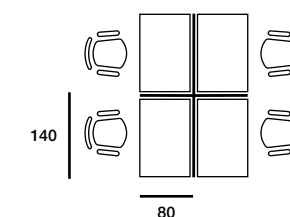



| ÉCRANS DE PROTECTION
| SUSPENDUS

| MAMPARAS PROTECTORAS
| COLGANTES

| HANGING PROTECTION
| SCREENS

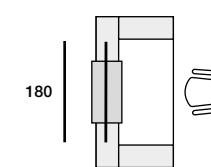



MODÈLES | VARIANTES | VERSIONS

SUR SUPPORT EN MÉTHACRYLATE / CON SOPORTE DE METACRILATO / WITH METHACRYLATE SUPPORT

MODÈLE / VARIANTES / VERSIONS	DIMENSIONS / MEDIDAS / MEASUREMENTS	RÉFÉRENCE / REFERENCIA / CODE
	120 x 67 x 0,3 cm 100 x 67 x 0,3 cm 80 x 67 x 0,3 cm	2 U. / 2 U. / 2 screens 727.021.411 727.023.411 727.025.411
Écran de protection Mamparas protectoras Protection screens		4 U. / 4 U. / 4 screens 727.031.411 727.033.411 727.035.411
	120 x 67 x 0,3 cm 100 x 67 x 0,3 cm 80 x 67 x 0,3 cm	2 U. / 2 U. / 2 screens 727.022.411 727.024.411 727.026.411
Écran avec fente Mamparas con atención al cliente Screens for customer service		4 U. / 4 U. / 4 screens 727.032.411 727.034.411 727.036.411



SUR SUPPORT EN MÉTALLIQUE / CON SOPORTE METÁLICOS / WITH METAL SUPPORT

MODÈLE / VARIANTES / VERSIONS	DIMENSIONS / MEDIDAS / MEASUREMENTS	RÉFÉRENCE / REFERENCIA / CODE
	180 x 67 x 0,5 cm 160 x 67 x 0,5 cm 140 x 67 x 0,5 cm 120 x 67 x 0,5 cm 100 x 67 x 0,5 cm 80 x 67 x 0,5 cm	2 U. / 2 U. / 2 screens 725.112.411 725.114.411 725.116.411 725.118.411 725.120.411 725.122.411
Écran de protection Mamparas protectoras Protection screens		4 U. / 4 U. / 4 screens 725.124.411 725.126.411 725.128.411 725.130.411 725.132.411 725.134.411
	180 x 67 x 0,5 cm 160 x 67 x 0,5 cm 140 x 67 x 0,5 cm 120 x 67 x 0,5 cm 100 x 67 x 0,5 cm 80 x 67 x 0,5 cm	2 U. / 2 U. / 2 screens 725.113.411 725.115.411 725.117.411 725.119.411 725.121.411 725.123.411
Écran avec fente Mamparas con atención al cliente Screens for customer service		4 U. / 4 U. / 4 screens 725.125.411 725.127.411 725.129.411 725.131.411 725.133.411 725.135.411

POUR CLOISONNETTES / PARA PLAFONES SEPARADORES / FOR SCREENS

MODÈLE / VARIANTES / VERSIONS	DIMENSIONS / MEDIDAS / MEASUREMENTS	RÉFÉRENCE / REFERENCIA / CODE
	178 x 32 x 0,6 cm 158 x 32 x 0,6 cm 138 x 32 x 0,6 cm 118 x 32 x 0,6 cm 98 x 32 x 0,6 cm 78 x 32 x 0,6 cm	727.160.411 727.161.411 727.162.411 727.163.411 727.164.411 727.165.411
Écrans de protection frontaux Mamparas protectoras frontales Front protection screens		727.260.411 727.261.411 727.262.411 727.263.411 727.264.411 727.265.411
	160 x 32 x 0,6 cm 140 x 32 x 0,6 cm 120 x 32 x 0,6 cm 100 x 32 x 0,6 cm 80 x 32 x 0,6 cm 60 x 32 x 0,6 cm	727.170.411 727.171.411 727.172.411 727.173.411 727.174.411 727.175.411
Écrans de protection latérales Mamparas protectoras laterales Side protection screens		727.270.411 727.271.411 727.272.411 727.273.411 727.274.411 727.275.411

ÉCRANS DE PROTECTION / MAMPARAS PROTECTORAS / METHACRYLATE SCREEN

MODÈLE / VARIANTES / VERSIONS	DIMENSIONS / MEDIDAS / MEASUREMENTS	RÉFÉRENCE / REFERENCIA / CODE
	178 x 63,4 x 0,6 cm 158 x 63,4 x 0,6 cm 138 x 63,4 x 0,6 cm 118 x 63,4 x 0,6 cm 98 x 63,4 x 0,6 cm 78 x 63,4 x 0,6 cm	726.175.411 726.176.411 726.177.411 726.178.411 726.179.411 726.180.411
Écrans de protection frontaux Mamparas protectoras frontales Front protection screens		726.275.411 726.276.411 726.277.411 726.278.411 726.279.411 726.280.411
		726.375.411 726.376.411 726.377.411 726.378.411 726.379.411 726.380.411

FINITIONS | ACABADOS | FINISHES

CLOISONS / MAMPARA / SCREEN | FINITION DES PINCES / ACABADOS PINZAS / BRACKET FINISHES

Mét. Transparent
Met. Transparente
Clear methacrylate

 Blanc
Blanco
White
RAL 9016

 Argent
Plata
Silver
RAL 9006

 Graphite
Grafito
Graphite
RAL 7022

MODÈLES | VARIANTES | VERSIONS

MODÈLE / VARIANTES / VERSIONS	TYPE / TIPO / TYPE	DIMENSIONS / MEDIDAS / MEASUREMENTS	RÉFÉRENCE / REFERENCIA / CODE
		158 x 57,5 x 0,6 cm 138 x 57,5 x 0,6 cm 118 x 57,5 x 0,6 cm	726.193.411 726.194.411 726.195.411

Écran de protection pour luminaires
Mamparas protectoras para luminarias
Protection screens for lighting

	Pour plafonds Para obra For concrete-steel ceiling	180 x 90 x 0,4 cm 160 x 90 x 0,4 cm 140 x 90 x 0,4 cm 120 x 90 x 0,4 cm 80 x 90 x 0,4 cm	724.002.411 724.004.411 724.006.411 724.008.411 724.012.411
-----------------------------------------------------------------------------------	----------------------------------------------------------	------------------------------------------------------------------------------------------------------	-------------------------------------------------------------------------

	Pour faux plafonds Para techos técnicos For suspending ceiling	180 x 90 x 0,4 cm 160 x 90 x 0,4 cm 140 x 90 x 0,4 cm 120 x 90 x 0,4 cm 80 x 90 x 0,4 cm	724.102.411 724.104.411 724.106.411 724.108.411 724.112.411
-----------------------------------------------------------------------------------	----------------------------------------------------------------------	------------------------------------------------------------------------------------------------------	-------------------------------------------------------------------------

Écrans de protection suspendus
Mamparas protectoras colgantes
Hanging protection screens



COLLECTIVITÉS
COLECTIVIDADES
MULTI-PURPOSE TABLES



342 | CADÍ



348 | ESPACE



356 | NEXOS



362 | NET

Cadí

En combinant les dimensions disponibles, vous pourrez toujours meubler votre local pour petit qu'il soit.

Combinando las medidas disponibles siempre se puede encontrar un modelo que se adapte a un local, por pequeño que sea.

By combining different measurements, customized furniture ensembles can be created to suit rooms of any size.

PLATEAU / SOBRE / DESK TOP

Mélamine / Melamina / Melamine
Stratifié / Estratificado / Stratified 19 mm

Chant en ABS / Canto ABS / ABS edges

STRUCTURE / ESTRUCTURA / FRAME

Acier:
Acero: 30 x 30 x 1,5 mm
Steel:



Périmétrale / Perimetral / Perimeter

FINITION STRUCTURE / ACABADO ESTRUCTURA / FRAME FINISH

Peinture époxy
Pintura epoxi
Epoxy paint

HAUTEUR / ALTURA / HEIGHT

72 cm

TABLE
RECTANGULAIRE

MESA
RECTANGULAR

RECTANGULAR
DESK



TABLE
TRAPÉZOÏDALE

MESA
TRAPEZOIDAL

TRAPEZOIDAL
DESK

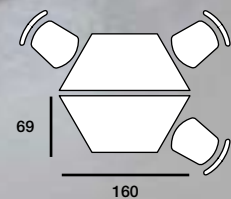
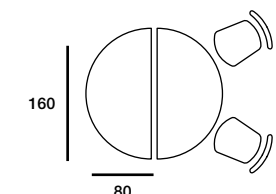

TABLE
DEMI-RONDE

MESA
SEMICIRCULAR

SEMICIRCULAR
DESK

La table trapézoïdale permet plusieurs compositions.
La mesa trapezoidal permite hacer múltiples composiciones.
With the trapezoidal desk many shapes are available.













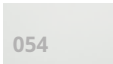
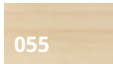

MODÈLES | VARIANTES | VERSIONS

MODÈLE / VARIANTES / VERSIONS	DIMENSIONS / MEDIDAS / MEASUREMENTS	RÉFÉRENCE / REFERENCIA / CODE		
		■	■	■
 <p>Table rectangulaire Rectangular Rectangular</p>	180 x 80 cm	48.001.-..	48.011.-..	48.021.-..
	160 x 80 cm	48.002.-..	48.012.-..	48.022.-..
	140 x 80 cm	48.003.-..	48.013.-..	48.023.-..
	120 x 80 cm	48.004.-..	48.014.-..	48.024.-..
	80 x 80 cm	48.005.-..	48.015.-..	48.025.-..
 <p>Table rectangulaire Rectangular Rectangular</p>	160 x 70 cm	48.007.-..	48.017.-..	48.027.-..
	140 x 70 cm	48.008.-..	48.018.-..	48.028.-..
	120 x 70 cm	48.009.-..	48.019.-..	48.029.-..
	70 x 70 cm	48.006.-..	48.016.-..	48.026.-..
 <p>Table demi-ronde Semicircular Semicircular</p>	160 x 80 cm	48.040.-..	48.041.-..	48.042.-..
	140 x 70 cm	48.044.-..	48.045.-..	48.046.-..
 <p>Table trapézoïdale Trapezoidal Trapezoidal</p>	160 x 80 cm	48.050.-..	48.051.-..	48.052.-..
	140 x 70 cm	48.054.-..	48.055.-..	48.056.-..

FINITIONS | ACABADOS | FINISHES

STRUCTURE / ESTRUCTURA / FRAME | PLATEAU / SOBRE / DESKTOP

 Noir Negro Black RAL 9005	 053 Blanc Blanco White	 054 Gris Gris Grey	 055 Hêtre Haya Beech	 061 Chêne Moyen Roble Maple
 Argent Plata Silver RAL 9006	 062 Poirier Peral Pear	 116 Wengué Wengue Wengue	 103 Acacia Clair Acacia Clara Light Acacia	 104 Acacia Foncé Acacia Oscura Dark Acacia
 Graphite Grafito Graphite RAL 7022	 007 Graphite Grafito Graphite	 272 Chêne Veiné Castaño Claro Oak	 273 Chêne Grisé Castaño Oscuro Dark Oak	

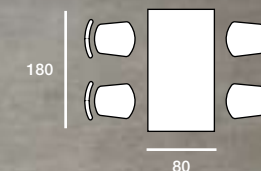

espace

Espace s'adapte à toutes les ambiances de travail, recherchant l'élégance des formes et la simplicité des finitions.

Son caractère polyvalent permet de créer différents espaces. Un programme pour collectivités et bureaux sous un même nom.

Espace se adapta a los espacios de trabajo actuales buscando la simplicidad de formas y acabados. Programa de colectividades y oficina bajo un mismo nombre.

ESPACE fits in every office style. Simple looking with a round pole leg. Its versatility will allow to provide different environments. Useful for any kind of corner or room.

PLATEAU / SOBRE / DESK TOP

Mélamine / Melamina / Melamine
Stratifié / Estratificado / Stratified 25 mm

Chant en ABS / Canto ABS / ABS edges

STRUCTURE / ESTRUCTURA / FRAME

Acier: Ø 55 x 1,5 mm
Acero: Ø 55 x 1,5 mm
Steel: Ø 55 x 1,5 mm



FINITION STRUCTURE / ACABADO ESTRUCTURA / FRAME FINISH

Peinture époxy
Pintura epoxi
Epoxy paint

HAUTEUR / ALTURA / HEIGHT

Fixe: 73 cm
Fija: 73 cm
Fixed: 73 cm

Réglable: 69,5 < 80,5 cm
Regulable: 69,5 < 80,5 cm
Adjustable: 69,5 < 80,5 cm

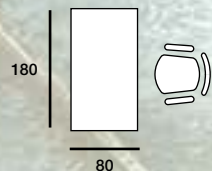

RÉGLABLE
EN HAUTEUR

REGULABLE
EN ALTURA

ADJUSTABLE
HEIGHT



TABLE
RECTANGULAIRE
AVEC COINS
ARRONDIS

MESA
RECTANGULAR
CON CANTOS
REDONDEADOS

RECTANGULAR
DESK WITH
ROUNDED
EDGES

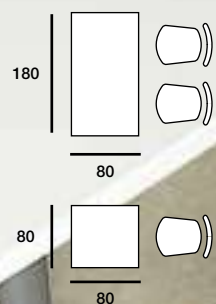

TABLE
DEMI-RONDE

MESA SEMI-CIRCULAR
CON MESA RECTA

SEMICIRCULAR
DESK

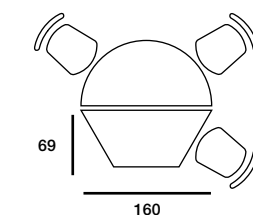

TABLE
TRAPÉZOÏDALE +
DEMI-RONDE

MESA
TRAPEZOIDAL
CON MESA
SEMI-CIRCULAR

TRAPEZOIDAL
DESK

La table trapézoïdale permet plusieurs compositions.
La mesa trapezoidal permite hacer múltiples composiciones.
With the trapezoidal desk many shapes are available.



MODÈLES | VARIANTES | VERSIONS

HAUTEUR FIXE / FIJAS / FIXED HEIGHT

MODÈLE / VARIANTES / VERSIONS	DIMENSIONS / MEDIDAS / MEASUREMENTS	RÉFÉRENCE / REFERENCIA / CODE	
	180 x 80 cm	Coins droits Cantos rectos Square edges	Coins arrondis Cantos redondeados Round edges
	160 x 80 cm	371.301.---	371.501.---
	140 x 80 cm	371.302.---	371.502.---
	120 x 80 cm	371.303.---	371.503.---
	80 x 80 cm	371.304.---	371.504.---
		371.305.---	371.505.---
	180 x 70 cm	371.331.---	371.531.---
	160 x 70 cm	371.332.---	371.532.---
	140 x 70 cm	371.333.---	371.533.---
	120 x 70 cm	371.334.---	371.534.---
80 x 70 cm	371.335.---	371.535.---	
Table rectangulaire Rectangular Rectangular	180 x 60 cm	371.371.---	371.571.---
	160 x 60 cm	371.372.---	371.572.---
	140 x 60 cm	371.373.---	371.573.---
	120 x 60 cm	371.374.---	371.574.---
	80 x 60 cm	371.375.---	371.575.---

	160 x 80 cm	371.314.---	371.514.---
	140 x 70 cm	371.344.---	371.544.---
	120 x 60 cm	371.384.---	371.584.---
Table demi-ronde Semicircular Semicircular			

	160 x 69,3 cm	371.310.---	371.510.---
	140 x 60,6 cm	371.340.---	371.540.---
	120 x 52 cm	371.380.---	371.580.---
Table trapézoïdale Trapezoidal Trapezoidal			

RÉGLABLE EN HAUTEUR / REGULABLE EN ALTURA / ADJUSTABLE HEIGHT





MODÈLE / VARIANTES / VERSIONS	DIMENSIONS / MEDIDAS / MEASUREMENTS	RÉFÉRENCE / REFERENCIA / CODE	
	180 x 80 cm	Coins droits Cantos rectos Square edges	Coins arrondis Cantos redondeados Round edges
	160 x 80 cm	371.401.---	371.601.---
	140 x 80 cm	371.402.---	371.602.---
	120 x 80 cm	371.403.---	371.603.---
	80 x 80 cm	371.404.---	371.604.---
		371.405.---	371.605.---
	180 x 70 cm	371.431.---	371.631.---
	160 x 70 cm	371.432.---	371.632.---
	140 x 70 cm	371.433.---	371.633.---
	120 x 70 cm	371.434.---	371.634.---
80 x 70 cm	371.435.---	371.635.---	
Table rectangulaire Rectangular Rectangular	180 x 60 cm	371.471.---	371.671.---
	160 x 60 cm	371.472.---	371.672.---
	140 x 60 cm	371.473.---	371.673.---
	120 x 60 cm	371.474.---	371.674.---
	80 x 60 cm	371.475.---	371.675.---

	160 x 80 cm	371.414.---	371.614.---
	140 x 70 cm	371.444.---	371.644.---
	120 x 60 cm	371.484.---	371.684.---
Table demi-ronde Semicircular Semicircular			

	160 x 69,3 cm	371.410.---	371.610.---
	140 x 60,6 cm	371.440.---	371.640.---
	120 x 52 cm	371.480.---	371.680.---
Table trapézoïdale Trapezoidal Trapezoidal			

FINITIONS | ACABADOS | FINISHES

STRUCTURE / ESTRUCTURA / FRAME | PLATEAU / SOBRE / DESK TOP

	060 Blanc Blanco White	064 Gris Gris Grey	065 Hêtre Haya Beech	066 Chêne Moyen Roble Maple	067 Poirier Peral Pear
	068 Wengué Wengue Wengue	706 Acacia Clair Acacia Clara Light Acacia	707 Acacia Foncé Acacia Oscura Dark Acacia	020 Graphite Grafito Graphite	031 Chêne Veiné Castaño Claro Oak
	032 Chêne Grisé Castaño Oscuro Dark Oak				
	096 Blanc Blanco White	097 Gris Gris Grey	098 Hêtre Haya Beech	099 Chêne Moyen Roble Maple	100 Poirier Peral Pear
	101 Wengué Wengue Wengue	709 Acacia Clair Acacia Clara Light Acacia	710 Acacia Foncé Acacia Oscura Dark Acacia	017 Graphite Grafito Graphite	166 Chêne Veiné Castaño Claro Oak
	167 Chêne Grisé Castaño Oscuro Dark Oak				
	102 Blanc Blanco White	153 Gris Gris Grey	154 Hêtre Haya Beech	155 Chêne Moyen Roble Maple	156 Poirier Peral Pear
	158 Wengué Wengue Wengue	712 Acacia Clair Acacia Clara Light Acacia	713 Acacia Foncé Acacia Oscura Dark Acacia	165 Graphite Grafito Graphite	189 Chêne Veiné Castaño Claro Oak
	193 Chêne Grisé Castaño Oscuro Dark Oak				
	163 Blanc Blanco White	180 Gris Gris Grey	181 Hêtre Haya Beech	182 Chêne Moyen Roble Maple	183 Poirier Peral Pear
	184 Wengué Wengue Wengue	715 Acacia Clair Acacia Clara Light Acacia	716 Acacia Foncé Acacia Oscura Dark Acacia	113 Graphite Grafito Graphite	206 Chêne Veiné Castaño Claro Oak
	208 Chêne Grisé Castaño Oscuro Dark Oak				

Nexos

Les sommets et les matériaux naturels qui composent la table NEXOS créent des environnements légers, organiques et agréables. Un design polyvalent idéal pour habiter des espaces collectifs tels que des cantines, des espaces de repos et des zones de travail informelles.

Los vértices y los materiales naturales que conforman la mesa NEXOS crean ambientes ligeros, orgánicos y placenteros. Un diseño versátil y polivalente perfecto para habitar espacios colectivos como cantinas, espacios de descanso y zonas de trabajo informal.

The natural materials of the Nexos table create bright, organic, and pleasant environments. A versatile design perfect for multi-purpose spaces such as canteens, rest spaces and informal work areas.

PLATEAU / SOBRE / DESKTOP

Mélamine / Melamina / Melamine: 25 mm

Chant en ABS / Canto ABS / ABS edges

STRUCTURE / ESTRUCTURA / FRAME

Bois: 45 x 45 mm - 25 x 25 mm 45
Madera: 45 x 45 mm - 25 x 25 mm 45-25
Wood: 45 x 45 mm - 25 x 25 mm 45-25

Bois: 45 x 30 mm 45
Madera: 45 x 30 mm 45
Wood: 45 x 30 mm 30

FINITION STRUCTURE / ACABADO ESTRUCTURA / FRAME FINISH

Bois vernis
Madera barnizada
Wood veneer

HAUTEUR / ALTURA / HEIGHT

76 mm

75 mm

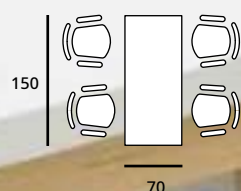
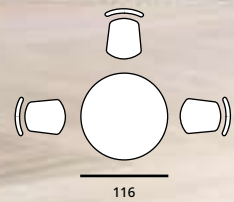



TABLE
RONDE

MESA
REDONDA

ROUND
TABLE



MODÈLES | VARIANTES | VERSIONS

MODÈLE / VARIANTES / VERSIONS	TYPE / TIPO / TYPE	DIMENSIONS / MEDIDAS / MEASUREMENTS		RÉFÉRENCE / REFERENCIA / CODE
	Rectangulaire / Rectangular / Rectangular	150 x 70 cm 130 x 70 cm 110 x 70 cm 70 x 70 cm		171.502.-.- 171.504.-.- 171.506.-.- 171.508.-.-
Bureau individuel Mesa individual Individual desks				
	Ronde / Redondo / Round	H. 75 cm	Ø130 cm Ø116 cm Ø100 cm Ø75 cm	171.510.-.- 171.512.-.- 171.514.-.- 171.516.-.-
Bureau individuel Mesa individual Individual desks				

FINITIONS | ACABADOS | FINISHES

STRUCTURE / ESTRUCTURA / FRAME | PLATEAU / SOBRE / DESKTOP

	053	Blanc Blanco White	054	Gris Gris Grey	055	Hêtre Haya Beech	061	Chêne Moyen Roble Maple
	062	Poirier Peral Pear	116	Wengué Wengue Wengue	103	Acacia Clair Acacia Clara Light Acacia	104	Acacia Foncé Acacia Oscura Dark Acacia
	007	Graphite Grafito Graphite	272	Chêne Veiné Castaño Claro Oak	273	Chêne Grisé Castaño Oscuro Dark Oak		

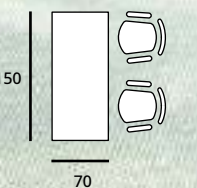

Net

Table polyvalente qui grâce à ses formes et à sa mobilité permet la création de multiples combinaisons.

Mesa polivalente de múltiples posibilidades, gracias a su movilidad y variedad de formas.

Multipurpose table thanks to its great variety of shapes.

TABLE
RECTANGULAIRE

MESA
RECTANGULAR

RECTANGULAR
DESK



PLATEAU / SOBRE / DESK TOP

Mélamine / Melamina / Melamine:
Stratifié / Estratificado / Stratified: 25 mm / 30 mm

Chant en ABS / Canto ABS / ABS edges

STRUCTURE / ESTRUCTURA / FRAME

Aluminium
Aluminio
Aluminium



FINITION STRUCTURE / ACABADO ESTRUCTURA / FRAME FINISH

Peinture époxy
Pintura epoxi
Epoxy paint

HAUTEUR / ALTURA / HEIGHT

74 cm

OPTION / OPCIÓN / OPTION

Voile de fond / Faldón / Modesty panel

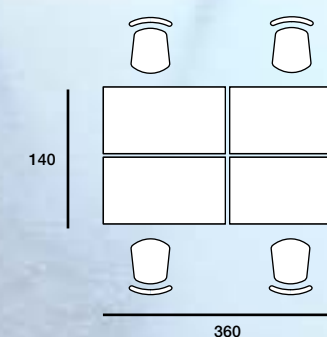



Elle peut facilement se ranger grâce à son plateau rabattable.
Se puede almacenar sin ocupar mucho espacio gracias a su sobre abatible.
Can be stored in a corner thanks to its foldable top.

La table avec quart de rond intégré nous permet créer plusieurs compositions.
La mesa con ángulo permite hacer varias composiciones.
Desk with angle allow multiple configurations.

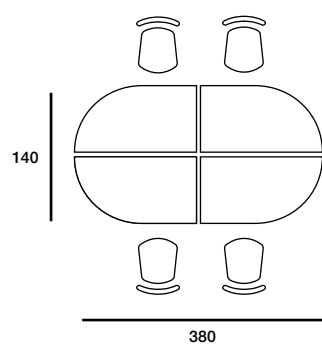

PLATEAU
AVEC ANGLE

MESA
CON ÁNGULO

DESK
WITH ANGLE

TABLE
DEMI-RONDE

MESA
SEMICIRCULAR



SEMICIRCULAR
DESK

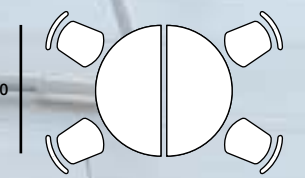

Roulettes équipées avec freins.
Las mesas disponen de ruedas con freno.
Wheels have brakes.





MODÈLES | VARIANTES | VERSIONS

MODÈLE / VARIANTES / VERSIONS	TYPE / TIPO / TYPE	DIMENSIONS / MEDIDAS / MEASUREMENTS	RÉFÉRENCE / REFERENCIA / CODE
 Table rectangulaire Rectangular	Démontées / Desmontadas / Disassembled	180 x 70 cm 150 x 70 cm 120 x 70 cm	551.002... 551.005... 551.008...
	Semi montées / Semi montadas / Semi-assembled	180 x 70 cm 150 x 70 cm 120 x 70 cm	551.202... 551.205... 551.208...
 Table avec angle Mesa con ángulo Desk with angle	Démontées / Desmontadas / Disassembled	190 x 70 cm	551.020... À droite / Derecha / Right 551.021... À gauche / Izquierda / Left
	Semi montées / Semi montadas / Semi-assembled	190 x 70 cm	551.220... 551.221...
 Table demi-ronde Semicircular	Démontées / Desmontadas / Disassembled	180 x 90 cm	551.030...
	Semi montées / Semi montadas / Semi-assembled	180 x 90 cm	551.230...

FINITIONS | ACABADOS | FINISHES

STRUCTURE / ESTRUCTURA / FRAME | PLATEAU / SOBRE / DESK TOP

 Aluminium + argent Aluminio + plata Aluminium + silver	074 Blanc Blanco White	069 Gris Gris Grey	020 Graphite Grafito Graphite	070 Hêtre Haya Beech	071 Chêne Moyen Roble Maple
	072 Poirier Peral Pear	073 Wengué Wengue Wengue	730 Acacia Clair Acacia Clara Light Acacia	731 Acacia Foncé Acacia Oscura Dark Acacia	041 Chêne Veiné Castaño Claro Oak
	042 Chêne Grisé Castaño Oscuro Dark Oak				
 Aluminium + blanc Aluminio + blanco Aluminium + white	082 Blanc Blanco White	083 Gris Gris Grey	321 Graphite Grafito Graphite	084 Hêtre Haya Beech	085 Chêne Moyen Roble Maple
	086 Poirier Peral Pear	087 Wengué Wengue Wengue	733 Acacia Clair Acacia Clara Light Acacia	734 Acacia Foncé Acacia Oscura Dark Acacia	121 Chêne Veiné Castaño Claro Oak
	122 Chêne Grisé Castaño Oscuro Dark Oak				

COMPLÉMENTS | COMPLEMENTOS | COMPLEMENTS

MODÈLE / VARIANTES / VERSIONS	DIMENSIONS / MEDIDAS / MEASUREMENTS	RÉFÉRENCE / REFERENCIA / CODE
 Voiles de fond Faldones Modesty panels	Mélamine / Melamina / Melamine	180 cm 1.551.402.051 1.551.402.053 1.551.402.007
		150 cm 1.551.405.051 1.551.405.053 1.551.405.007
		120 cm / 190 cm 1.551.408.051 1.551.408.053 1.551.408.007

FINITIONS | ACABADOS | FINISHES

 Argent Plata Silver	 Blanc Blanco White	 Graphite Grafito Graphite
---------------------------------------------------------------------------------------------------------------	--------------------------------------------------------------------------------------------------------------	---------------------------------------------------------------------------------------------------------------------

COMPLÉMENTS | COMPLEMENTOS | COMPLEMENTS

MODÈLE / VARIANTES / VERSIONS	TYPE / TIPO / TYPE	RÉFÉRENCE / REFERENCIA / CODE
	2 unités incluses / Incluye dos unidades / 2 units included	1.551.300.000

Pièce union tables
Piezas unión mesas
Linking bracket

EXEMPLES | EJEMPLOS | EXAMPLES

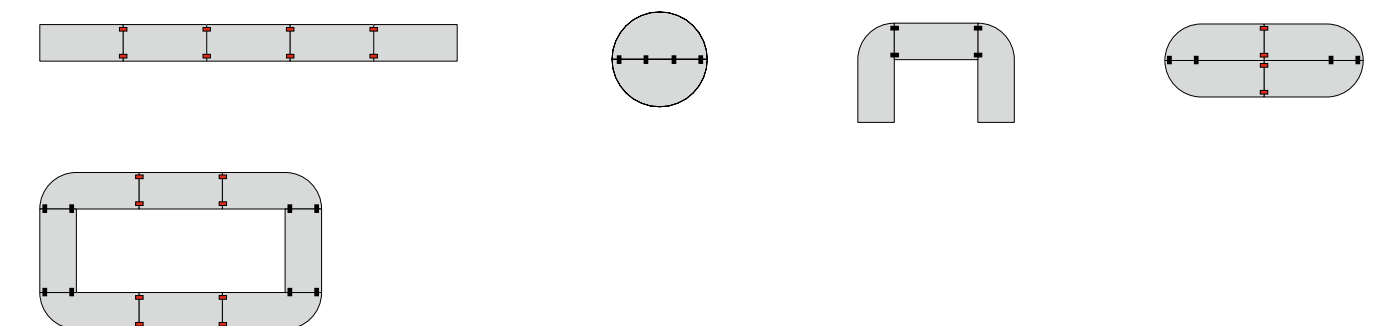

ACCUEIL
RECEPCIÓN
RECEPTION



374 | DELTA



388 | ROCK RECEPTION

Delta

Le banque d'accueil DELTA se démarque par ses lignes droites, de design atemporel. Elle propose 2 gammes: La Basique, plus simple et uniquement modulable en horizontal; et la gamme PLUS, avec illumination LED, formes variées et rehausse optionnelle.

El mostrador DELTA destaca por sus líneas rectas, un minimalismo que lo convierte en un diseño atemporal. Ofrece dos gamas: Basic, más sencilla y con crecimiento horizontal; y la gama Plus, con iluminación LED y altillo opcional.

DELTA counter has a timeless design thanks to its straight lines. Basic range is simple and with horizontal expansion. Plus range has LED lights and an optional upper counter top.

MODULE / MÓDULO / LOW STORAGE

Mélamine / Melamina / Melamine: 25 mm

Chant en ABS / Canto ABS / ABS edges

FINITION STRUCTURE / ACABADO ESTRUCTURA / FRAME FINISH

Mélamine
Melamina
Melamine

HAUTEUR / ALTURA / HEIGHT

Fixe:
Fija: 73, 110 cm
Fixed:

OPTION / OPCIÓN / OPTION

Rehausse / Altillo / Upper counter top
Socle avec éclairage / Zócalo con luz Led / Socle with Led light
Goulotte / Bandeja electrificación / Cable tray
Support écran / Soporte pantalla / Monitor holder

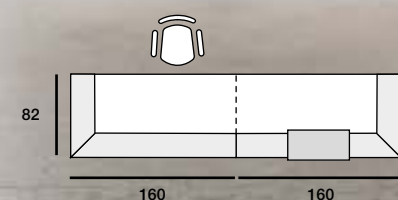

| DELTA PLUS

| DELTA PLUS

| DELTA PLUS



DELTA PLUS
AVEC MODULE
BUREAU D'ACCUEIL

DELTA PLUS
CON ATENCIÓN
AL CLIENTE

DELTA PLUS
WITH DESK
HEIGHT COUNTER

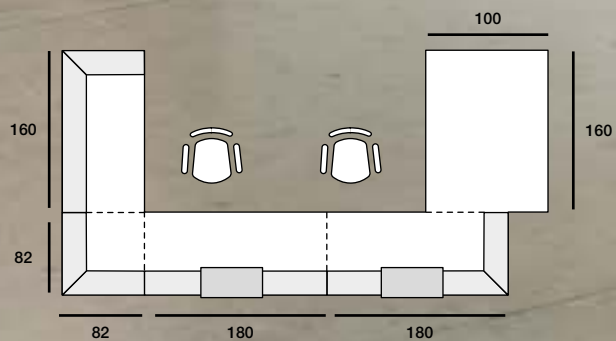

DELTA PLUS
AVEC SUPPORT
ÉCRAN

DELTA PLUS
CON SOPORTE
PARA PANTALLAS

DELTA PLUS
WITH MONITOR
HOLDER

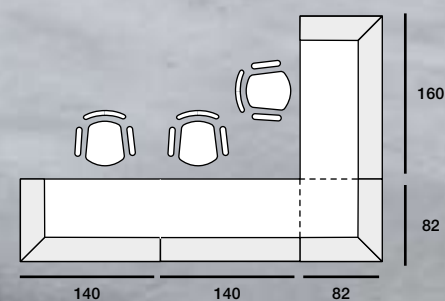

Deux options pour mettre en place l'écran.
Dos opciones distintas para colocar el monitor.
Two different ways to fix the computer screen.



DELTA
BASIC

DELTA
BASIC

DELTA
BASIC

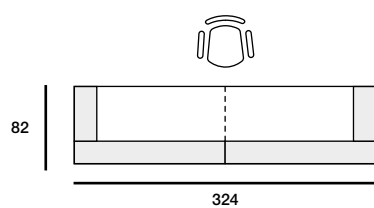

MODÈLES | VARIANTES | VERSIONS

DELTA PLUS - AVEC ÉCLAIRAGE / CON LUZ / WITH LIGHT

MODÈLE / VARIANTES / VERSIONS	TYPE / TIPO / TYPE	DIMENSIONS / MEDIDAS / MEASUREMENTS	RÉFÉRENCE / REFERENCIA / CODE	
	H. 110 cm	Droite / Derecha / Right	Option écran Opción pantalla PC screen option	
		A2	182,2 x 82,1 cm 162,2 x 82,1 cm 142,2 x 82,1 cm 102,2 x 82,1 cm 82,2 x 82,1 cm (90°)	622.212... 622.412... 622.216... 622.416... 622.220... 622.420... 622.227... 622.427... 622.224... 622.424...
	H. 110 cm	Gauche / Izquierda / Left		
		A1	182,2 x 82,1 cm 162,2 x 82,1 cm 142,2 x 82,1 cm 102,2 x 82,1 cm 82,2 x 82,1 cm (90°)	622.214... 622.414... 622.218... 622.418... 622.222... 622.422... 622.228... 622.428... 622.226... 622.426...
	H. 110 cm	B	180 x 82,1 cm 160 x 82,1 cm 140 x 82,1 cm	622.230... 622.430... 622.232... 622.432... 622.234... 622.434...
		B2	Droite / Derecha / Right 82,2 x 82,1 cm	622.236...
	H. 110 cm	B1	Gauche / Izquierda / Left 82,2 x 82,1 cm	622.237...

DELTA PLUS - SANS ÉCLAIRAGE / SIN LUZ / WITHOUT LIGHT

MODÈLE / VARIANTES / VERSIONS	TYPE / TIPO / TYPE	DIMENSIONS / MEDIDAS / MEASUREMENTS	RÉFÉRENCE / REFERENCIA / CODE	
	H. 110 cm	Droite / Derecha / Right	Option écran Opción pantalla PC screen option	
		A2	182,2 x 82,1 cm 162,2 x 82,1 cm 142,2 x 82,1 cm 102,2 x 82,1 cm 82,2 x 82,1 cm (90°)	622.112... 622.312... 622.116... 622.316... 622.120... 622.320... 622.127... 622.327... 622.124... 622.324...
	H. 110 cm	Gauche / Izquierda / Left		
		A1	182,2 x 82,1 cm 162,2 x 82,1 cm 142,2 x 82,1 cm 102,2 x 82,1 cm 82,2 x 82,1 cm (90°)	622.114... 622.314... 622.118... 622.318... 622.122... 622.322... 622.128... 622.328... 622.126... 622.326...
	H. 110 cm	B	180 x 82,1 cm 160 x 82,1 cm 140 x 82,1 cm	622.130... 622.330... 622.132... 622.332... 622.134... 622.334...
		B2	Droite / Derecha / Right 82,2 x 82,1 cm (90°)	622.136...
	H. 110 cm	B1	Gauche / Izquierda / Left 82,2 x 82,1 cm (90°)	622.137...

EXEMPLE | EJEMPLOS | EXAMPLES

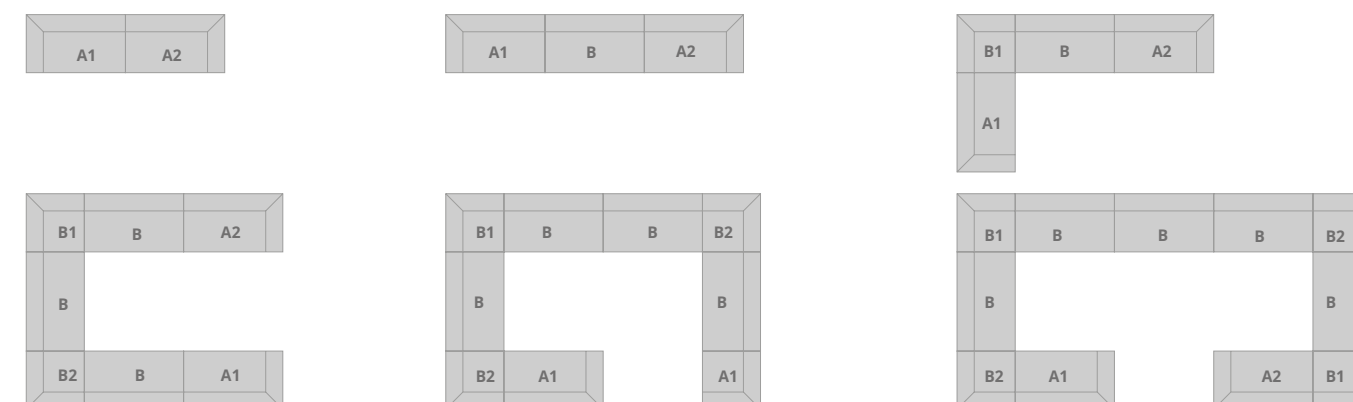

MODÈLES | VARIANTES | VERSIONS

DELTA PLUS - AVEC ÉCLAIRAGE / CON LUZ / WITH LIGHT

MODÈLE / VARIANTES / VERSIONS	TYPE / TIPO / TYPE	DIMENSIONS / MEDIDAS / MEASUREMENTS	RÉFÉRENCE / REFERENCIA / CODE	
	H. 73 cm	Droite / Derecha / Right		
		A2	180 x 100 cm 160 x 100 cm 140 x 100 cm 100 x 100 cm 100 x 120 cm	622.240... 622.440... 622.244... 622.444... 622.248... 622.448... 622.251... 622.451... 622.253... 622.453...
	H. 73 cm	Gauche / Izquierda / Left		
		A1	180 x 100 cm 160 x 100 cm 140 x 100 cm 100 x 100 cm 100 x 120 cm	622.242... 622.442... 622.246... 622.446... 622.250... 622.450... 622.252... 622.452... 622.254... 622.454...
	H. 73 cm	B	180 x 100 cm 160 x 100 cm 140 x 100 cm	622.260... 622.460... 622.262... 622.462... 622.264... 622.464...
		B1	100 x 120 cm	622.265...

DELTA PLUS - SANS ÉCLAIRAGE / SIN LUZ / WITHOUT LIGHT

MODÈLE / VARIANTES / VERSIONS	TYPE / TIPO / TYPE	DIMENSIONS / MEDIDAS / MEASUREMENTS	RÉFÉRENCE / REFERENCIA / CODE	
	H. 73 cm	Droite / Derecha / Right		
		A2	180 x 100 cm 160 x 100 cm 140 x 100 cm 100 x 100 cm 100 x 120 cm	622.140... 622.340... 622.144... 622.344... 622.148... 622.348... 622.151... 622.351... 622.153... 622.353...
	H. 73 cm	Gauche / Izquierda / Left		
		A1	180 x 100 cm 160 x 100 cm 140 x 100 cm 100 x 100 cm 100 x 120 cm	622.142... 622.342... 622.146... 622.346... 622.150... 622.350... 622.152... 622.352... 622.154... 622.354...
	H. 73 cm	B	180 x 100 cm 160 x 100 cm 140 x 100 cm	622.160... 622.360... 622.162... 622.362... 622.164... 622.364...
		B1	100 x 120 cm	622.165...

FINITIONS | ACABADOS | FINISHES

204	Graphite Grafito Graphite	051	Argent Plata Silver	053	Blanc Blanco White	197	Gris Gris Grey	198	Hêtre Haya Beech
199	Chêne Moyen Roble Maple	200	Poirier Peral Pear	202	Wengué Wengue Wengue	103	Acacia Clair Acacia Clara Light Acacia	104	Acacia Foncé Acacia Oscura Dark Acacia
209	Chêne Veiné Castaño Claro Oak	235	Chêne Grisé Castaño Oscuro Dark Oak						

MODÈLES | VARIANTES | VERSIONS

DELTA PLUS - AVEC ÉCLAIRAGE / CON LUZ / WITH LIGHT

MODÈLE / VARIANTES / VERSIONS	TYPE / TIPO / TYPE	DIMENSIONS / MEDIDAS / MEASUREMENTS	RÉFÉRENCE / REFERENCIA / CODE
	H. 110 cm	184,4 x 82,1 cm 164,4 x 82,1 cm 144,4 x 82,1 cm	Option écran Opción pantalla PC screen option 622.202.-.- 622.402.-.- 622.204.-.- 622.404.-.- 622.206.-.- 622.406.-.-
Individuel Individual Individual			

DELTA PLUS - SANS ÉCLAIRAGE / SIN LUZ / WITHOUT LIGHT

MODÈLE / VARIANTES / VERSIONS	TYPE / TIPO / TYPE	DIMENSIONS / MEDIDAS / MEASUREMENTS	RÉFÉRENCE / REFERENCIA / CODE
	H. 110 cm	184,4 x 82,1 cm 164,4 x 82,1 cm 144,4 x 82,1 cm	Option écran Opción pantalla PC screen option 622.102.-.- 622.302.-.- 622.104.-.- 622.304.-.- 622.106.-.- 622.306.-.-
Individuel Individual Individual			

COMPLÉMENTS | COMPLEMENTOS | COMPLEMENTS

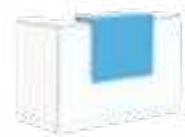
MODÈLE / VARIANTES / VERSIONS	DIMENSIONS / MEDIDAS / MEASUREMENTS	RÉFÉRENCE / REFERENCIA / CODE
	80 x 36 cm	Option éclairage Con luz With light 622.170.-.- * 624.170.-.- *
Rehausse Atillo Upper counter top	120 x 36 cm	622.172.-.- * 624.172.-.- *

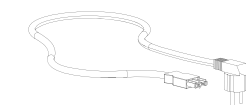

Éclairage
Latiguillo
Light

ES	DE	FR	US	UK
446.991.000			446.992.000	446.995.000

FINITIONS | ACABADOS | FINISHES

204 Graphite Grafito Graphite	051 Argent Plata Silver	053 Blanc Blanco White	197 Gris Gris Grey	198 Hêtre Haya Beech
199 Chêne Moyen Roble Maple	200 Poirier Peral Pear	202 Wengué Wengue Wengue	103 Acacia Clair Acacia Clara Light Acacia	104 Acacia Foncé Acacia Oscura Dark Acacia
209 Chêne Veiné Castaño Claro Oak	235 Chêne Grisé Castaño Oscuro Dark Oak	* Cf. page 464 Ver pagina 464 See page 464		

MODÈLES | VARIANTES | VERSIONS

DELTA BASIC

MODÈLE / VARIANTES / VERSIONS	TYPE / TIPO / TYPE	DIMENSIONS / MEDIDAS / MEASUREMENTS	RÉFÉRENCE / REFERENCIA / CODE
	H. 110 cm	184,4 x 82,1 cm 164,4 x 82,1 cm 144,4 x 82,1 cm	621.102.-.- 621.104.-.- 621.106.-.-
Terminal Terminal Individual			

MODÈLE / VARIANTES / VERSIONS	TYPE / TIPO / TYPE	DIMENSIONS / MEDIDAS / MEASUREMENTS	RÉFÉRENCE / REFERENCIA / CODE
	H. 110 cm	364,4 x 82,1 cm 324,4 x 82,1 cm 284,4 x 82,1 cm	621.112.-.- 621.114.-.- 621.116.-.-
Double Doble Double			

MODÈLE / VARIANTES / VERSIONS	TYPE / TIPO / TYPE	DIMENSIONS / MEDIDAS / MEASUREMENTS	RÉFÉRENCE / REFERENCIA / CODE
	H. 110 cm	C 180 x 82,1 cm 160 x 82,1 cm 140 x 82,1 cm	621.122.-.- 621.124.-.- 621.126.-.-
Central Central Add-on			

EXEMPLE | EJEMPLOS | EXAMPLES

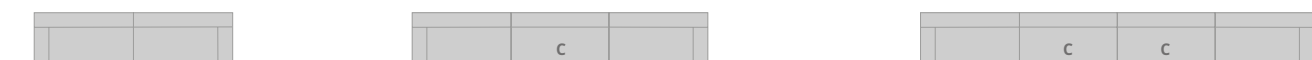

FINITIONS | ACABADOS | FINISHES

204 Graphite Grafito Graphite	051 Argent Plata Silver	053 Blanc Blanco White	197 Gris Gris Grey	198 Hêtre Haya Beech
199 Chêne Moyen Roble Maple	200 Poirier Peral Pear	202 Wengué Wengue Wengue	103 Acacia Clair Acacia Clara Light Acacia	104 Acacia Foncé Acacia Oscura Dark Acacia
209 Chêne Veiné Castaño Claro Oak	235 Chêne Grisé Castaño Oscuro Dark Oak			

| COMPLÉMENTS | COMPLEMENTOS | COMPLEMENTS

MODÈLE / VARIANTES / VERSIONS	DIMENSIONS / MEDIDAS / MEASUREMENTS	RÉFÉRENCE / REFERENCIA / CODE		
	159 x 11,4 x 9,8 cm 139 x 11,4 x 9,8 cm 119 x 11,4 x 9,8 cm 59 x 11,4 x 9,8 cm	RAL 9006 1.566.002.111	RAL 9016 1.566.002.108	RAL 7022 1.566.002.107
		1.566.003.111	1.566.003.108	1.566.003.107
		1.566.004.111	1.566.004.108	1.566.004.107
		1.566.008.111	1.566.008.108	1.566.008.107

Goulotte pour banquettes d'accueil
 Bandeja de electrificación
 Cable tray

| FINITIONS | ACABADOS | FINISHES

STRUCTURE / ESTRUCTURA / FRAME

 Argent Plata Silver RAL 9006	 Blanc Blanco White RAL 9016	 Graphite Grafito Graphite RAL 7022
----------------------------------------------------------------------------------------------------------------------------	---------------------------------------------------------------------------------------------------------------------------	----------------------------------------------------------------------------------------------------------------------------------

| COMPLÉMENTS | COMPLEMENTOS | COMPLEMENTS

MODÈLE / VARIANTES / VERSIONS	RÉFÉRENCE / REFERENCIA / CODE
	626.001.124

Support écran
 Soporte pantalla
 Monitor holder

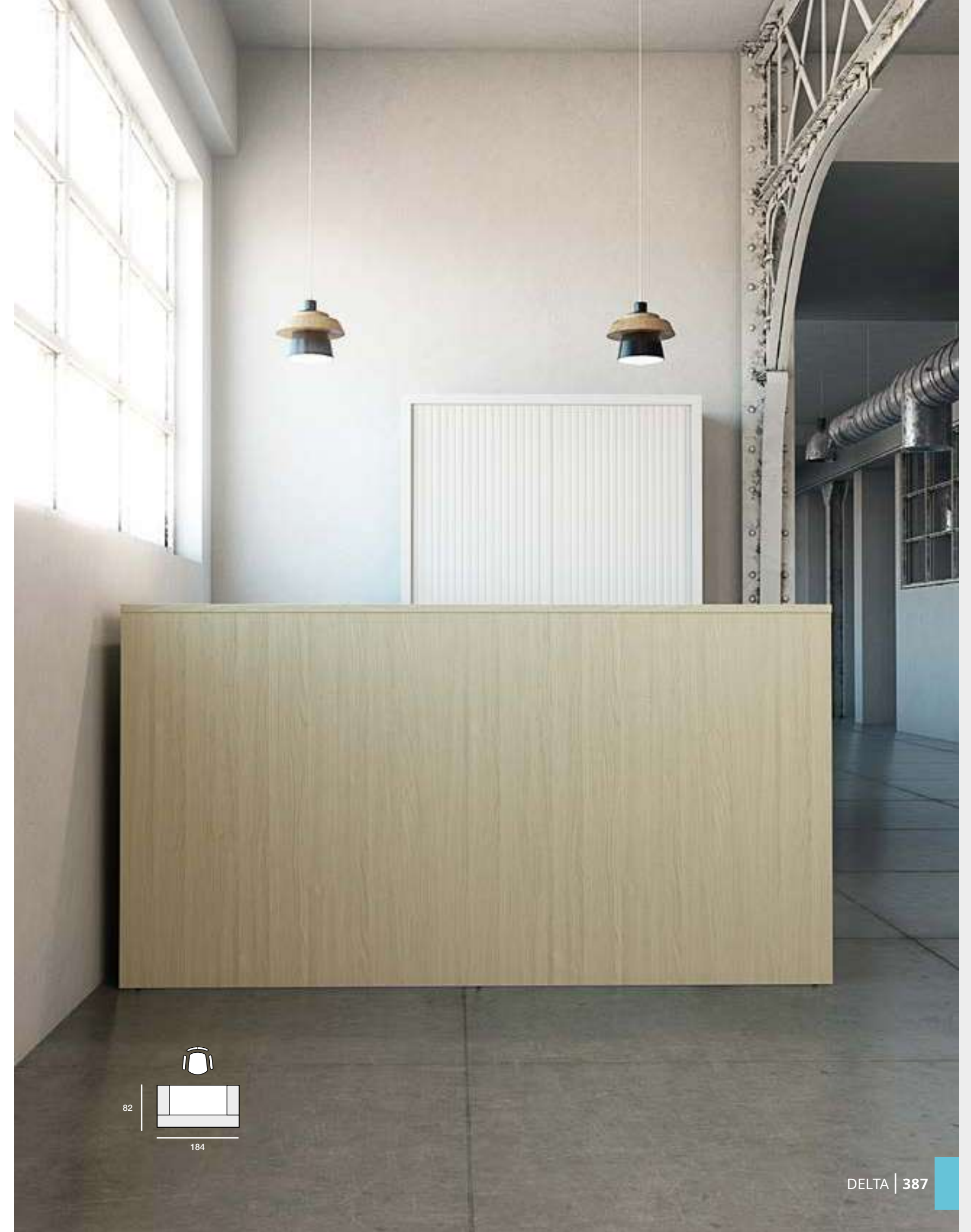

ROCK RECEPTION

ROCK RECEPTION est une série de banques d'accueil modulaires qui offre de multiples combinaisons pour obtenir un ensemble visuellement attrayant. Vous pouvez créer des banques d'accueil sur mesure, pour refléter la personnalité de votre entreprise.

ROCK RECEPTION es un completo programa de mostradores modulares que se combinan a voluntad para diseñar un conjunto optimizado, estético y comfortable. Se pueden crear recepciones a medida.

ROCK RECEPTION is a complete range of modular reception counters designed with elements that can be combined to create an optimum, comfortable and visually appealing reception. It is important to customize a reception area to reflect the unique personality of a company or organisation.

MODULE / MÓDULO / MODULE

Mélamine / Melamina / Melamine: 25 mm

Verre trempé / Cristal securizado / Tempered beveled glass: 13 mm

Chant en ABS / Canto ABS / ABS edges

FINITION STRUCTURE / ACABADO ESTRUCTURA / FRAME FINISH

Aluminium
Aluminio
Aluminum

FINITION CLOISONS / ACABADOS MAMPARA / SCREEN FINISHES

Mélamine / Melamina / Melamine

HAUTEUR / ALTURA / HEIGHT

Fixe: 106,9, 73 cm Réglable: 112,35 > 118,75 cm
Fija: 106,9, 73 cm Regulable: 112,35 > 118,75 cm
Fixed: 106,9, 73 cm Adjustable: 112,35 > 118,75 cm

BANQUES
D'ACCUEIL
MULTI-PANNEAUX

MOSTRADORES
MULTIPANEL

MULTI PANEL
COUNTER

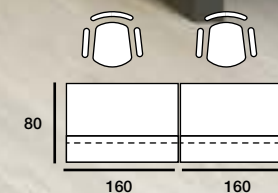

| BUREAU PMR

| MESA ATENCIÓN
AL CLIENTE

| HANDICAPPED
DESK



Disponible en angle 45° ou droit.
Disponible en ángulo o mesa recta.
Straight or curved shape available.

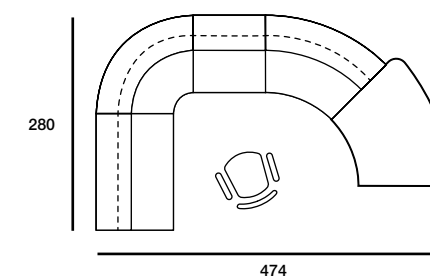
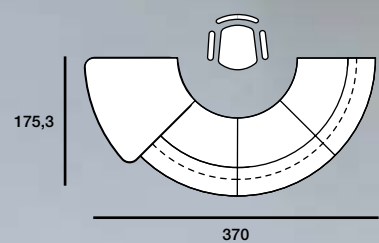

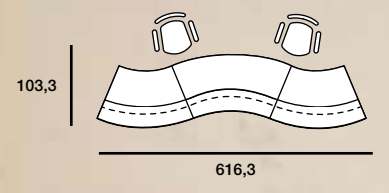

REHAUSSE FIXE
OU RÉGLABLE
EN HAUTEUR

MOSTRADOR FIJO
O REGULABLE
EN ALTURA

FIXED OR HEIGHT
ADJUSTABLE
COUNTER

BANQUES D'ACCUEIL
UN SEUL PANNEAU

MOSTRADORES
UNIPANEL

SINGLE
PANEL COUNTER

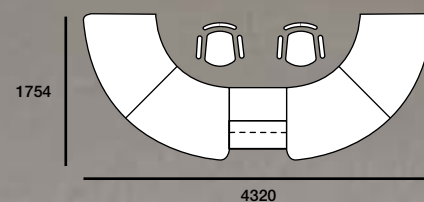

MODÈLES | VARIANTES | VERSIONS

UN SEUL PANNEAU - ROCK 3 / UNIPANEL - ROCK 3 / SINGLE PANEL - ROCK 3

MODÈLE / VARIANTES / VERSIONS	TYPE / TIPO / TYPE	DIMENSIONS / MEDIDAS / MEASUREMENTS	RÉFÉRENCE / REFERENCIA / CODE
	Prof./Depth 60 cm	200,6 x 100 x 106,9 cm	433.144.-.-
	Prof./Depth 60 cm	318,8 x 99,4 x 106,9 cm	433.145.-.-
	Prof./Depth 60 cm	278,8 x 120 x 106,9 cm	433.146.-.-
	Prof./Depth 60 cm	299,4 x 194,7 x 106,9 cm	433.147.-.-
	Prof./Depth 60 cm	299,4 x 175,5 x 106,9 cm	433.148.-.-
	Prof./Depth 60 cm	296,4 x 175,5 x 106,9 cm	433.149.-.-
	Prof./Depth 60 cm	296,4 x 195,2 x 106,9 cm	433.150.-.-
	Prof./Depth 60 cm	350,7 x 175,5 x 106,9 cm	433.151.-.-

MODÈLES | VARIANTES | VERSIONS

MODÈLE / VARIANTES / VERSIONS	TYPE / TIPO / TYPE	DIMENSIONS / MEDIDAS / MEASUREMENTS	RÉFÉRENCE / REFERENCIA / CODE
	Prof./Depth 60 cm	375,4 x 103,3 x 106,9 cm	433.154.-.-
	Prof./Depth 60 cm	198,8 x 99,4 x 106,9 cm	433.141.-.-
	Prof./Depth 60 cm	198,8 x 169,6 x 106,9 cm	433.140.-.-
	Prof./Depth 60 cm	616,3 x 103,3 x 106,9 cm	433.155.-.-

FINITIONS | ACABADOS | FINISHES

REHAUSSE / SOBRE / COUNTER TOP | LATÉRAUX / LATERAL / PANEL LEG

Rehausse en mélamine Sobre mostrador en melamina Melamine counter top	053	Blanc Blanco White	054	Gris Gris Grey	055	Hêtre Haya Beech	061	Chêne Moyen Roble Maple	062	Poirier Peral Pear	063	Wengué Wengue
	103	Acacia Clair Acacia Clara Light Acacia	104	Acacia Foncé Acacia Oscura Dark Acacia	007	Graphite Grafito Graphite						
Rehausse en verre Sobre mostrador en vidrio Glass counter top	453	Blanc Blanco White	454	Gris Gris Grey	455	Hêtre Haya Beech	461	Chêne Moyen Roble Maple	462	Poirier Peral Pear	463	Wengué Wengue
	793	Acacia Clair Acacia Clara Light Acacia	794	Acacia Foncé Acacia Oscura Dark Acacia	487	Graphite Grafito Graphite						

MODÈLES | VARIANTES | VERSIONS

MULTI PANNEAUX - ROCK 3 / MULTIPANEL - ROCK 3 / MULTI PANEL - ROCK 3

MODÈLE / VARIANTES / VERSIONS	TYPE / TIPO / TYPE	DIMENSIONS / MEDIDAS / MEASUREMENTS	RÉFÉRENCE / REFERENCIA / CODE
	Prof./Depth 60 cm	200,6 x 100 x 106,9 cm	433.344.-.-
	Prof./Depth 60 cm	318,8 x 99,4 x 106,9 cm	433.345.-.-
	Prof./Depth 60 cm	278,8 x 120 x 106,9 cm	433.346.-.-
	Prof./Depth 60 cm	299,4 x 194,7 x 106,9 cm	433.347.-.-
	Prof./Depth 60 cm	299,4 x 175,5 x 106,9 cm	433.348.-.-
	Prof./Depth 60 cm	296,4 x 175,5 x 106,9 cm	433.349.-.-
	Prof./Depth 60 cm	296,4 x 195,2 x 106,9 cm	433.350.-.-
	Prof./Depth 60 cm	350,7 x 175,5 x 106,9 cm	433.351.-.-

MODÈLE / VARIANTES / VERSIONS	TYPE / TIPO / TYPE	DIMENSIONS / MEDIDAS / MEASUREMENTS	RÉFÉRENCE / REFERENCIA / CODE
	Prof./Depth 60 cm	375,4 x 103,3 x 106,9 cm	433.354.-.-
	Prof./Depth 60 cm	198,8 x 99,4 x 106,9 cm	433.341.-.-
	Prof./Depth 60 cm	198,8 x 169,6 x 106,9 cm	433.340.-.-
	Prof./Depth 60 cm	616,3 x 103,3 x 106,9 cm	433.355.-.-

FINITIONS | ACABADOS | FINISHES



REHAUSSE / SOBRE / COUNTER TOP | LATÉRAUX / LATERAL / PANEL LEG

Rehausse en mélamine Sobre mostrador en melamina Melamine counter top	053	Blanc Blanco White	054	Gris Gris Grey	055	Hêtre Haya Beech	061	Chêne Moyen Roble Maple	062	Poirier Peral Pear	063	Wengué Wengue
	103	Acacia Clair Acacia Clara Light Acacia	104	Acacia Foncé Acacia Oscura Dark Acacia	007	Graphite Grafito Graphite						
Rehausse en verre Sobre mostrador en vidrio Glass counter top	453	Blanc Blanco White	454	Gris Gris Grey	455	Hêtre Haya Beech	461	Chêne Moyen Roble Maple	462	Poirier Peral Pear	463	Wengué Wengue
	793	Acacia Clair Acacia Clara Light Acacia	794	Acacia Foncé Acacia Oscura Dark Acacia	487	Graphite Grafito Graphite						

MODÈLES | VARIANTES | VERSIONS

UN SEUL PANNEAU - ROCK 4 / UNIPANEL - ROCK 4 / SINGLE PANEL - ROCK 4

MODÈLE / VARIANTES / VERSIONS	TYPE / TIPO / TYPE	DIMENSIONS / MEDIDAS / MEASUREMENTS	RÉFÉRENCE / REFERENCIA / CODE
	Prof./Depth 60 cm	200,6 x 100 x 106,9 cm	443.144. - - -
	Prof./Depth 60 cm	318,8 x 99,4 x 106,9 cm	443.145. - - -
	Prof./Depth 60 cm	278,8 x 120 x 106,9 cm	443.146. - - -
	Prof./Depth 60 cm	299,4 x 194,7 x 106,9 cm	443.147. - - -
	Prof./Depth 60 cm	299,4 x 175,5 x 106,9 cm	443.148. - - -
	Prof./Depth 60 cm	296,4 x 175,5 x 106,9 cm	443.149. - - -
	Prof./Depth 60 cm	296,4 x 195,2 x 106,9 cm	443.150. - - -
	Prof./Depth 60 cm	350,7 x 175,5 x 106,9 cm	443.151. - - -

MODÈLE / VARIANTES / VERSIONS	TYPE / TIPO / TYPE	DIMENSIONS / MEDIDAS / MEASUREMENTS	RÉFÉRENCE / REFERENCIA / CODE
	Prof./Depth 60 cm	375,4 x 103,3 x 106,9 cm	443.154. - - -
	Prof./Depth 60 cm	616,3 x 103,3 x 106,9 cm	443.155. - - -







FINITIONS | ACABADOS | FINISHES



REHAUSSE / SOBRE / COUNTER TOP | LATÉRAUX / LATERAL / FRAME

Rehausse en mélamine Sobre mostrador en melamina Melamine counter top	Argent / Argent Plata / Plata Silver / Silver	Blanc / Blanc Blanco / Blanco White / White	Argent / Argent Plata / Plata Silver / Silver	Blanc / Blanc Blanco / Blanco White / White	Argent / Argent Plata / Plata Silver / Silver	Blanc / Blanc Blanco / Blanco White / White	Argent / Argent Plata / Plata Silver / Silver	Blanc / Blanc Blanco / Blanco White / White	Argent / Argent Plata / Plata Silver / Silver	Blanc / Blanc Blanco / Blanco White / White									
060	Blanc Blanco White	064	Gris Gris Grey	065	Hêtre Haya Beech	066	Chêne Moyen Roble Maple	067	Poirier Peral Pear	068	Wengué Wengue	706	Acacia Clair Acacia Clara Light Acacia	707	Acacia Foncé Acacia Oscura Dark Acacia	007	Graphite Grafito Graphite		
096	Blanc Blanco White	460	Blanc Blanco White	464	Gris Gris Grey	465	Hêtre Haya Beech	466	Chêne Moyen Roble Maple	467	Poirier Peral Pear	468	Wengué Wengue	805	Acacia Clair Acacia Clara Light Acacia	806	Acacia Foncé Acacia Oscura Dark Acacia	268	Graphite Grafito Graphite
	096	Blanc Blanco White	496	Blanc Blanco White															

MODÈLES | VARIANTES | VERSIONS

MULTI PANNEAUX - ROCK 4 / MULTIPANEL - ROCK 4 / MULTI PANEL - ROCK 4



MODÈLE / VARIANTES / VERSIONS	TYPE / TIPO / TYPE	DIMENSIONS / MEDIDAS / MEASUREMENTS	RÉFÉRENCE / REFERENCIA / CODE
	Prof./Depth 60 cm	200,6 x 100 x 106,9 cm	443.344.-.-
	Prof./Depth 60 cm	318,8 x 99,4 x 106,9 cm	443.345.-.-
	Prof./Depth 60 cm	278,8 x 120 x 106,9 cm	443.346.-.-
	Prof./Depth 60 cm	299,4 x 194,7 x 106,9 cm	443.347.-.-
	Prof./Depth 60 cm	299,4 x 175,5 x 106,9 cm	443.348.-.-
	Prof./Depth 60 cm	296,4 x 175,5 x 106,9 cm	443.349.-.-
	Prof./Depth 60 cm	296,4 x 195,2 x 106,9 cm	443.350.-.-
	Prof./Depth 60 cm	350,7 x 175,5 x 106,9 cm	443.351.-.-

MODÈLE / VARIANTES / VERSIONS	TYPE / TIPO / TYPE	DIMENSIONS / MEDIDAS / MEASUREMENTS	RÉFÉRENCE / REFERENCIA / CODE
	Prof./Depth 60 cm	375,4 x 103,3 x 106,9 cm	443.354.-.-
	Prof./Depth 60 cm	616,3 x 103,3 x 106,9 cm	443.355.-.-

FINITIONS | ACABADOS | FINISHES

REHAUSSE / SOBRE / COUNTER TOP

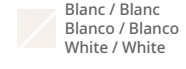
LATÉRAUX / LATERAL / FRAME

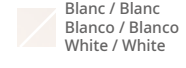
Rehausse en mélamine Sobre mostrador en melamina Melamine counter top		060 Blanc Blanco White	064 Gris Gris Grey	065 Hêtre Haya Beech	066 Chêne Moyen Roble Maple	067 Poirier Peral Pear
		068 Wengué Wengue	706 Acacia Clair Acacia Clara Light Acacia	707 Acacia Foncé Acacia Oscura Dark Acacia	007 Graphite Grafito Graphite	
		096 Blanc Blanco White				
Rehausse en verre Sobre mostrador en vidrio Glass counter top		460 Blanc Blanco White	464 Gris Gris Grey	465 Hêtre Haya Beech	466 Chêne Moyen Roble Maple	467 Poirier Peral Pear
		468 Wengué Wengue	805 Acacia Clair Acacia Clara Light Acacia	806 Acacia Foncé Acacia Oscura Dark Acacia	268 Graphite Grafito Graphite	
		496 Blanc Blanco White				

RANGEMENT
ALMACENAJE
STORAGE



406 | OH SYSTEMS



424 | METÁLICA



442 | LOK



456 | ORGATOWER

OH Systems

Ordre et rangement définiront votre nouvel espace de travail. Grâce à sa grande variété de modèles et à ses multiples combinaisons OH Systems trouve sa place dans tous les bureaux.

Sistema modular de armarios. Orden y archivo definen el nuevo espacio de trabajo. OH Systems se adapta a cualquier oficina gracias a la gran variedad de modelos y a las múltiples combinaciones.

Tidiness and a good filing organization will improve the working space. A huge variety of functional types with Oh Systems drillings can match in any office.

MODULE / MÓDULO / STORAGE

Mélamine / Melamina / Melamine: 25 mm
Chant en ABS / Canto ABS / ABS edges

FINITION STRUCTURE / ACABADO ESTRUCTURA / FRAME FINISH

Mélamine
Melamina
Melamine

HAUTEUR / ALTURA / HEIGHT

Fixe:
Fija: 41'5, 73, 81, 120, 158, 196, 235 cm
Fixed:



ARMOIRES
PUSH OPEN

ARMARIOS
PUSH OPEN

PUSH OPEN
CABINETS

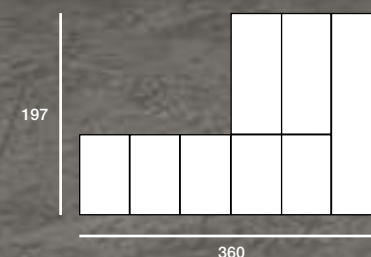



ARMOIRES
OUVERTES

ARMARIOS
HUECO

SHELVES
CABINETS

La cremallière des armoires OH Systems permet de placer les étagères et d'autres accessoires tout les 32 mm.

El sistema OH Systems permite colocar estantes y otros complementos cada 32 mm.

OH Systems drilling pattern permit to hang shelves every 32 mm.

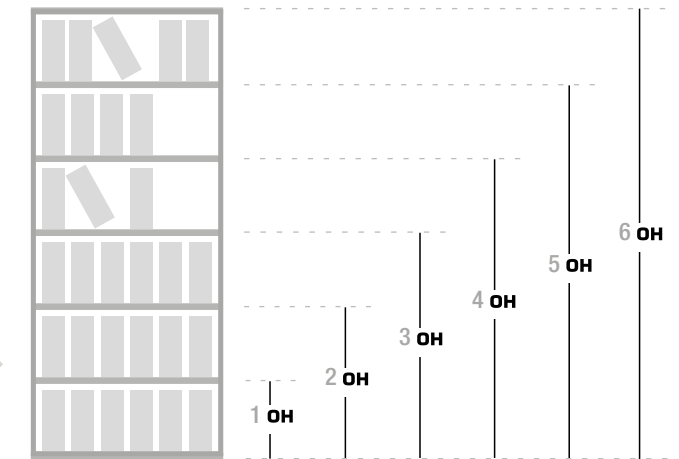
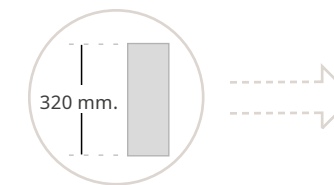

Option étagère fixe.
Opción estante fijo.
Fixed shelf.



Option étagère normale.
Opción estante móvil.
Normal shelf.

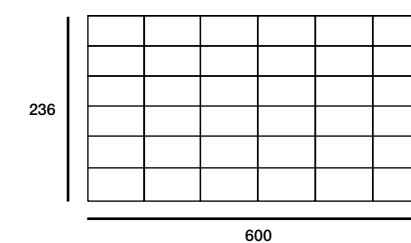

| ARMOIRES OUVERTES -
| PORTES OU DS

| ARMARIOS HUECO -
| PUERTAS O ARCHIVO

| CABINET WITH SHELVES
| AND DOORS OR FILES

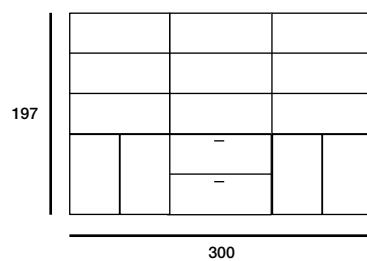



PORTES
EN VERRE

PUERTAS
DE VIDRIO

GLASS
DOORS



Détail poignées
Detalle tiradores
Handles detail



Portes push open
Puertas push open
Push open doors

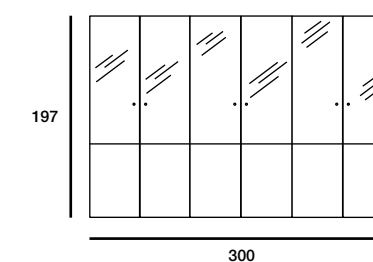



DOSSIERS
SUSPENDUS

ARCHIVOS

FILES

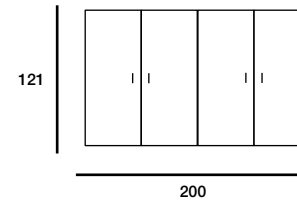
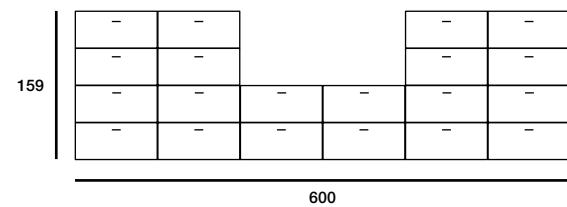

ARMOIRES
PORTES
BATTANTES

ARMARIOS
CON
PUERTAS

CABINETS
WITH
DOORS



| CAISSON
| MÉLAMINE

| CAJONERA
| MELAMINA

| MELAMINE
| PEDESTAL



Deux types de poignées disponibles.
Tirador disponible en dos modelos.
Two types of handles available.

| CAISSON PORTEUR
| CAJONERA SOPORTANTE
| FIXED PEDESTAL

L'intérieur du tiroir peut être en mélamine ou en métal.
Pueden ser con cajón interior de melamina o de metal.
Melamine or metal slide for drawers.



| CAISSON À ROULETTES
| CAJONERA CON RUEDAS
| MOBILE PEDESTALS

Roulettes visibles ou non visibles.
Las ruedas puedan ser vistas u ocultas.
Available with hidden wheels.



| CRÉDENCE MÉLAMINÉE
| CREDENCIA MELAMINA
| MELAMINE CREDENZA

Espace pour UC + porte coulissante + tiroirs.
Con hueco para CPU + puerta corredera + cajones.
With CPU gap + sliding door + drawers.



| ACCESSOIRES CAISSONS
| ACCESORIOS PARA CUBETAS
| PEDESTAL ACCESSORIES



MODÈLES | VARIANTES | VERSIONS

ARMOIRES / ARMARIOS / CABINETS



ÉTAGÈRES INCLUSES / ESTANTES INCLUIDOS / INCLUDED SHELVES

MODÈLE / VARIANTES / VERSIONS	TYPE / TIPO / TYPE	H.	RÉFÉRENCE / REFERENCIA / CODE	
	Prof./ Depth. 42 cm		L. 100 cm	L. 80 cm
Armoire ouverte avec étagères Armario hueco Shelves cabinet		236 cm	764.021.-..	764.037.-..
		197 cm	764.023.-..	764.039.-..
		159 cm	764.025.-..	764.041.-..
		121 cm	764.027.-..	764.043.-..
		82,5 cm	764.029.-..	764.045.-..
	73 cm	765.749.-..	765.751.-..	
43,5 cm	765.031.-..	765.047.-..		
	Prof./ Depth. 42 cm			
Armoire portes battantes Armario con puertas batientes Hinged doors cabinet		236 cm	764.103.-..	764.133.-..
		197 cm	764.107.-..	764.137.-..
		159 cm	764.111.-..	764.141.-..
		121 cm	764.115.-..	764.145.-..
		82,5 cm	764.119.-..	764.149.-..
	73 cm	765.761.-..	765.765.-..	
43,5 cm	765.123.-..	765.153.-..		
	Prof./ Depth. 42 cm			
Armoire portes push-open Armario push open Push open door cabinet		236 cm	763.103.-..	763.133.-..
		197 cm	763.107.-..	763.137.-..
		159 cm	763.111.-..	763.141.-..
		121 cm	763.115.-..	763.145.-..
		82,5 cm	763.119.-..	763.149.-..
	73 cm	767.761.-..	767.765.-..	
43,5 cm	767.123.-..	767.153.-..		
	Prof./ Depth. 45 cm	121 cm	364.259.-..	
Armoire portes coulissantes Puertas correderas Sliding doors cabinet		82,5 cm	364.261.-..	
		43,5 cm	365.263.-..	
		Prof./ Depth. 45 cm		
Armoire à rideaux Puertas persiana Tambour doors cabinet	197 cm		364.687.-..	
	159 cm		364.689.-..	
	121 cm		364.691.-..	
	82,5 cm		364.693.-..	
	73 cm		365.773.-..	
	43,5 cm	365.695.-..		
	Prof./ Depth. 60 cm	197 cm	365.729.-..	
Penderie Ropero Wardrobe		159 cm	365.731.-..	

MODÈLES | VARIANTES | VERSIONS

ARMOIRES / ARMARIOS / CABINETS

ÉTAGÈRES INCLUSES / ESTANTES INCLUIDOS / INCLUDED SHELVES

MODÈLE / VARIANTES / VERSIONS	TYPE / TIPO / TYPE	H.	RÉFÉRENCE / REFERENCIA / CODE	
	Prof./ Depth. 42 cm		L. 100 cm	L. 80 cm
Armoire DS Archivo File cabinet		159 cm	765.283.-..	765.291.-..
		121 cm	765.285.-..	765.293.-..
	82,5 cm	765.287.-..	765.295.-..	
	Prof./ Depth. 42 cm			
Armoire ouverte - portes Hueco - puertas Shelves with low doors		236 cm	764.519.-..	764.541.-..
		197 cm	764.523.-..	764.545.-..
	159 cm	764.527.-..	764.549.-..	

FINITIONS | ACABADOS | FINISHES

DESSOUS, JOUES ET FOND
BAJO, LATERALES Y TRASERA
BOTTOM, SIDE AND BACK PANELS



TOP ET ÉTAGÈRES
TAPA Y ESTANTE
TOP AND DIVIDER SHELF

Argent Plata Silver	051	Argent Plata Silver	075	Blanc Blanco White	054	Gris Gris Grey	055	Hêtre Haya Beech	061	Chêne Moyen Roble Maple
	062	Poirier Peral Pear	116	Wengué Wengue Wengue	694	Acacia Clair Acacia Clara Light Acacia	695	Acacia Foncé Acacia Oscura Dark Acacia	125	Graphite Grafito Graphite
	209	Chêne Veiné Castaño Claro Oak	235	Chêne Grisé Castaño Oscuro Dark Oak						
Blanc Blanco White	088	Argent Plata Silver	053	Blanc Blanco White	076	Gris Gris Grey	077	Hêtre Haya Beech	078	Chêne Moyen Roble Maple
	079	Poirier Peral Pear	080	Wengué Wengue Wengue	168	Acacia Clair Acacia Clara Light Acacia	169	Acacia Foncé Acacia Oscura Dark Acacia	115	Graphite Grafito Graphite
	043	Chêne Veiné Castaño Claro Oak	106	Chêne Grisé Castaño Oscuro Dark Oak						
Graphite Grafito Graphite	228	Argent Plata Silver	229	Blanc Blanco White	230	Gris Gris Grey	231	Hêtre Haya Beech	232	Chêne Moyen Roble Maple
	234	Poirier Peral Pear	700	Acacia Clair Acacia Clara Light Acacia	701	Acacia Foncé Acacia Oscura Dark Acacia	204	Graphite Grafito Graphite	251	Chêne Veiné Castaño Claro Oak
	252	Chêne Grisé Castaño Oscuro Dark Oak								
Monochrome Monocolor Single-colour	197	Gris Gris Grey	198	Hêtre Haya Beech	199	Chêne Moyen Roble Maple	200	Poirier Peral Pear	202	Wengué Wengue Wengue
	103	Acacia Clair Acacia Clara Light Acacia	104	Acacia Foncé Acacia Oscura Dark Acacia	209	Chêne Veiné Castaño Claro Oak	235	Chêne Grisé Castaño Oscuro Dark Oak		

MODÈLES | VARIANTES | VERSIONS

ARMOIRES / ARMARIOS / CABINETS

ÉTAGÈRES INCLUSES / ESTANTES INCLUIDOS / INCLUDED SHELVES

MODÈLE / VARIANTES / VERSIONS	TYPE / TIPO / TYPE	H.	RÉFÉRENCE / REFERENCIA / CODE	
	Prof./ Depth. 42 cm	197 cm 159 cm	L. 100 cm 764.643.-... 764.645.-...	L. 80 cm 764.655.-... 764.657.-...
Armoire ouverte - DS Hueco - archivo Shelves with low files				
	Prof./ Depth. 42 cm	236 cm 197 cm 159 cm	763.519.-... 763.523.-... 763.527.-...	763.541.-... 763.545.-... 763.549.-...
Armoire ouverte - portes en verre Hueco - puertas push open Shelves with low push open doors				

FINITIONS | ACABADOS | FINISHES

DESSOUS, JOUES ET FOND
BAJO, LATERALES Y TRASERA
BOTTOM, SIDE AND BACK PANELS

TOP ET ÉTAGÈRES
TAPA Y ESTANTE
TOP AND DIVIDER SHELF

Argent Plata Silver	051	Argent Plata Silver	075	Blanc Blanco White	054	Gris Gris Grey	055	Hêtre Haya Beech	061	Chêne Moyen Roble Maple
	062	Poirier Peral Pear	116	Wengué Wengue Wengue	694	Acacia Clair Acacia Clara Light Acacia	695	Acacia Foncé Acacia Oscura Dark Acacia	125	Graphite Grafito Graphite
	209	Chêne Veiné Castaño Claro Oak	235	Chêne Grisé Castaño Oscuro Dark Oak						
Blanc Blanco White	088	Argent Plata Silver	053	Blanc Blanco White	076	Gris Gris Grey	077	Hêtre Haya Beech	078	Chêne Moyen Roble Maple
	079	Poirier Peral Pear	080	Wengué Wengue Wengue	168	Acacia Clair Acacia Clara Light Acacia	169	Acacia Foncé Acacia Oscura Dark Acacia	115	Graphite Grafito Graphite
	043	Chêne Veiné Castaño Claro Oak	106	Chêne Grisé Castaño Oscuro Dark Oak						
Graphite Grafito Graphite	228	Argent Plata Silver	229	Blanc Blanco White	230	Gris Gris Grey	231	Hêtre Haya Beech	232	Chêne Moyen Roble Maple
	234	Poirier Peral Pear	700	Acacia Clair Acacia Clara Light Acacia	701	Acacia Foncé Acacia Oscura Dark Acacia	204	Graphite Grafito Graphite	251	Chêne Veiné Castaño Claro Oak
	252	Chêne Grisé Castaño Oscuro Dark Oak								
Monochrome Monocolor Single-colour	197	Gris Gris Grey	198	Hêtre Haya Beech	199	Chêne Moyen Roble Maple	200	Poirier Peral Pear	202	Wengué Wengue Wengue
	103	Acacia Clair Acacia Clara Light Acacia	104	Acacia Foncé Acacia Oscura Dark Acacia	209	Chêne Veiné Castaño Claro Oak	235	Chêne Grisé Castaño Oscuro Dark Oak		

MODÈLES | VARIANTES | VERSIONS

ARMOIRES VERRE / ARMARIOS VIDRIO / GLASS DOORS

ÉTAGÈRES INCLUSES / ESTANTES INCLUIDOS / INCLUDED SHELVES

MODÈLE / VARIANTES / VERSIONS	TYPE / TIPO / TYPE	H.	RÉFÉRENCE / REFERENCIA / CODE	
	Prof./ Depth. 42 cm	197 cm 159 cm 121 cm 82,5 cm	L. 100 cm 764.207.-... 764.209.-... 764.211.-... 764.213.-...	
Armoire portes en verre Armario con puertas vidrio Glass doors cabinet				
	Prof./ Depth. 42 cm	236 cm 197 cm 159 cm	764.595.-... 764.597.-... 764.599.-...	
Armoire ouverte - portes en verre Hueco - puertas vidrio Shelves with low glass doors				

FINITIONS | ACABADOS | FINISHES

PORTES EN VERRE
PUERTAS EN VIDRIO
GLASS DOORS

CORPS ARMOIRE
ARMAZÓN LIBRERÍA
FRAME

	TYPE / TIPO / TYPE A						TYPE / TIPO / TYPE B					
Blanc Blanco White	601	Blanc Blanco White	602	Gris Gris Grey	603	Hêtre Haya Beech	604	Chêne Moyen Roble Maple	605	Poirier Peral Pear	600	Argent Plata Silver
	606	Wengué Wengue Wengue	439	Acacia Clair Acacia Clara Light Acacia	442	Acacia Foncé Acacia Oscura Dark Acacia	607	Graphite Grafito Graphite	864	Chêne Veiné Castaño Claro Oak		
	865	Chêne Grisé Castaño Oscuro Dark Oak										
Noir Negro Black	613	Blanc Blanco White	614	Gris Gris Grey	615	Hêtre Haya Beech	616	Chêne Moyen Roble Maple	617	Poirier Peral Pear	612	Argent Plata Silver
	618	Wengué Wengue Wengue	440	Acacia Clair Acacia Clara Light Acacia	443	Acacia Foncé Acacia Oscura Dark Acacia	619	Graphite Grafito Graphite	866	Chêne Veiné Castaño Claro Oak		
	867	Chêne Grisé Castaño Oscuro Dark Oak										
Blanc opaque Translúcido Transparent	637	Blanc Blanco White	638	Gris Gris Grey	639	Hêtre Haya Beech	640	Chêne Moyen Roble Maple	641	Poirier Peral Pear	636	Argent Plata Silver
	642	Wengué Wengue Wengue	793	Acacia Clair Acacia Clara Light Acacia	794	Acacia Foncé Acacia Oscura Dark Acacia	643	Graphite Grafito Graphite	868	Chêne Veiné Castaño Claro Oak		
	869	Chêne Grisé Castaño Oscuro Dark Oak										
Transparent Transparente Clear	453	Blanc Blanco White	454	Gris Gris Grey	455	Hêtre Haya Beech	461	Chêne Moyen Roble Maple	462	Poirier Peral Pear	451	Argent Plata Silver
	486	Wengué Wengue Wengue	796	Acacia Clair Acacia Clara Light Acacia	797	Acacia Foncé Acacia Oscura Dark Acacia	487	Graphite Grafito Graphite	297	Chêne Veiné Castaño Claro Oak		
	298	Chêne Grisé Castaño Oscuro Dark Oak										

MODÈLES | VARIANTES | VERSIONS

CAISSONS / CAJONERAS / PEDESTALS

MODÈLE / VARIANTES / VERSIONS	TYPE / TIPO / TYPE	DIMENSIONS / MEDIDAS / MEASUREMENTS	RÉFÉRENCE / REFERENCIA / CODE
	Haut de gamme / Gama alta / Top range Gamme basique / Gama básica / Basic range Gamme mélamine / Gama madera / Melamine drawer	Prof./ Depth. 80 cm 44 x 73 cm 44 x 73 cm 44 x 73 cm	4 Tiroirs / Cajones / Drawers 2 Tiroirs / Cajones / Drawers + 1 DS / Archivo / File 402.400.--- 402.402.--- 402.404.--- 402.401.--- 402.403.--- 402.405.---
Caisson HB top rectangulaire Cajonera adosada Fixed pedestal with top	Haut de gamme / Gama alta / Top range Gamme basique / Gama básica / Basic range Gamme mélamine / Gama madera / Melamine drawer	Prof./ Depth. 60 cm 44 x 73 cm 44 x 73 cm 44 x 73 cm	402.342.--- 402.352.--- 402.363.--- 402.343.--- 402.353.--- 402.364.---
	Haut de gamme / Gama alta / Top range Gamme basique / Gama básica / Basic range Gamme mélamine / Gama madera / Melamine drawer	Prof./ Depth. 60 cm 44 x 73 cm 44 x 73 cm 44 x 73 cm	402.410.--- 402.412.--- 402.414.--- 402.411.--- 402.413.--- 402.415.---
Caisson avec top en arc Cajonera con sobre en forma arco Fixed pedestal with bow font			
	Haut de gamme / Gama alta / Top range Gamme basique / Gama básica / Basic range Gamme mélamine / Gama madera / Melamine drawer	Prof./ Depth. 80 cm 43 x 70,5 cm 43 x 70,5 cm 43 x 70,5 cm	4 Tiroirs / Cajones / Drawers 2 Tiroirs / Cajones / Drawers + 1 DS / Archivo / File 402.300.--- 402.310.--- 402.320.---
Caisson porteur Cajonera soportante Fixed pedestal (under desk top)	Haut de gamme / Gama alta / Top range Gamme basique / Gama básica / Basic range Gamme mélamine / Gama madera / Melamine drawer	Prof./ Depth. 60 cm 43 x 70,5 cm 43 x 70,5 cm 43 x 70,5 cm	402.302.--- 402.312.--- 402.323.--- 402.303.--- 402.313.--- 402.324.---
	Haut de gamme / Gama alta / Top range Gamme basique / Gama básica / Basic range Gamme mélamine / Gama madera / Melamine drawer	Roulette visibles / Ruedas visibles / Visible wheels 43,4 x 52,5 x 57,8 cm 43,4 x 52,5 x 57,8 cm 43,4 x 52,5 x 57,8 cm	3 Tiroirs / Cajones / Drawers 1 Tiroir / Cajón / Drawer + 1 DS / Archivo / File 402.304.--- 402.314.--- 402.326.---
Caisson à roulettes Cajonera con ruedas Mobile pedestal	Haut de gamme / Gama alta / Top range Gamme basique / Gama básica / Basic range Gamme mélamine / Gama madera / Melamine drawer	Roulettes non visibles / Ruedas ocultas / Hidden wheels 43,6 x 52,5 x 57,6 cm 43,6 x 52,5 x 57,6 cm 43,6 x 52,5 x 57,6 cm 33 x 52,5 x 58,7 cm	402.306.--- 402.316.--- 402.328.--- 402.330.--- 402.307.--- 402.317.--- 402.329.--- 402.331.---

FINITIONS | ACABADOS | FINISHES

CORPS / ESTRUCTURA / FRAME | FAÇADES ET TOP / DELANTERAS Y SOBRE / FRONTS AND TOP

Argent Plata Silver	051	Argent Plata Silver	053	Blanc Blanco White	054	Gris Gris Grey	055	Hêtre Haya Beech	061	Chêne Moyen Roble Maple
	062	Poirier Peral Pear	116	Wengué Wengue Wengue	694	Acacia Clair Acacia Clara Light Acacia	695	Acacia Foncé Acacia Oscura Dark Acacia	125	Graphite Grafito Graphite
	272	Chêne Veiné Castaño Claro Oak	273	Chêne Gris Castaño Oscuro Dark Oak						
Blanc Blanco White	088	Argent Plata Silver	053	Blanc Blanco White	076	Gris Gris Grey	077	Hêtre Haya Beech	078	Chêne Moyen Roble Maple
	079	Poirier Peral Pear	080	Wengué Wengue Wengue	168	Acacia Clair Acacia Clara Light Acacia	169	Acacia Foncé Acacia Oscura Dark Acacia	115	Graphite Grafito Graphite
	043	Chêne Veiné Castaño Claro Oak	106	Chêne Gris Castaño Oscuro Dark Oak						
Monochrome Monocolor Single-colour	197	Gris Gris Grey	198	Hêtre Haya Beech	199	Chêne Moyen Roble Maple	200	Poirier Peral Pear	202	Wengué Wengue Wengue
	103	Acacia Clair Acacia Clara Light Acacia	104	Acacia Foncé Acacia Oscura Dark Acacia	209	Chêne Veiné Castaño Claro Oak	235	Chêne Gris Castaño Oscuro Dark Oak		

MODÈLES | VARIANTES | VERSIONS

CRÉDENCE / CREDENCIA / CREDENZA

MODÈLE / VARIANTES / VERSIONS	TYPE / TIPO / TYPE	DIMENSIONS / MEDIDAS / MEASUREMENTS	RÉFÉRENCE / REFERENCIA / CODE
	Haut de gamme / Gama alta / Top range Gamme basique / Gama básica / Basic range Gamme mélamine / Gama madera / Melamine drawer	Gauche / Izquierda / Left 125,6 x 54,2 x 57,5 cm 125,6 x 54,2 x 57,5 cm 125,6 x 54,2 x 57,5 cm	3 Tiroirs / Cajones / Drawers 1 Tiroir / Cajón / Drawer + 1 DS / Archivo / File 362.405.--- 362.425.--- 362.445.--- 362.407.--- 362.427.--- 362.447.---
Crédence en mélamine Credencia de melamina Melamine credenza	Haut de gamme / Gama alta / Top range Gamme basique / Gama básica / Basic range Gamme mélamine / Gama madera / Melamine drawer	Droite / Derecha / Right 125,6 x 54,2 x 57,5 cm 125,6 x 54,2 x 57,5 cm 125,6 x 54,2 x 57,5 cm	362.404.--- 362.424.--- 362.444.--- 362.406.--- 362.426.--- 362.446.---

FINITIONS | ACABADOS | FINISHES

CORPS / ESTRUCTURA / FRAME | FAÇADES ET TOP / DELANTERAS Y SOBRE / FRONTS AND TOP

Blanc Blanco White	081	Blanc Blanco White	076	Gris Gris Grey	077	Hêtre Haya Beech	078	Chêne Moyen Roble Maple	079	Poirier Peral Pear
	080	Wengué Wengue Wengue	168	Acacia Clair Acacia Clara Light Acacia	169	Acacia Foncé Acacia Oscura Dark Acacia	043	Chêne Veiné Castaño Claro Oak	106	Chêne Gris Castaño Oscuro Dark Oak
Argent Plata Silver	053	Blanc Blanco White	054	Gris Gris Grey	055	Hêtre Haya Beech	061	Chêne Moyen Roble Maple	062	Poirier Peral Pear
	116	Wengué Wengue Wengue	694	Acacia Clair Acacia Clara Light Acacia	695	Acacia Foncé Acacia Oscura Dark Acacia	272	Chêne Veiné Castaño Claro Oak	273	Chêne Gris Castaño Oscuro Dark Oak
Monochrome Monocolor Single-colour	197	Gris Gris Grey	198	Hêtre Haya Beech	199	Chêne Moyen Roble Maple	200	Poirier Peral Pear	202	Wengué Wengue Wengue
	103	Acacia Clair Acacia Clara Light Acacia	104	Acacia Foncé Acacia Oscura Dark Acacia	209	Chêne Veiné Castaño Claro Oak	235	Chêne Gris Castaño Oscuro Dark Oak		

metálica

METÁLICA est une série d'armoires métalliques pouvant être montées ou démontées. Elle dispose d'une grande variété de modèles et de finitions.

METÁLICA es una serie de armarios metálicos que se pueden adquirir montados o desmontados. Dispone de una amplia gama de tipos y acabados.

METÁLICA is a range of metal cabinets that can be ordered assembled or disassembled. It has a wide range of types and finishes.

ARMOIRES
À RIDEAUX

ARMARIOS
PERSIANA

TAMBOUR DOORS

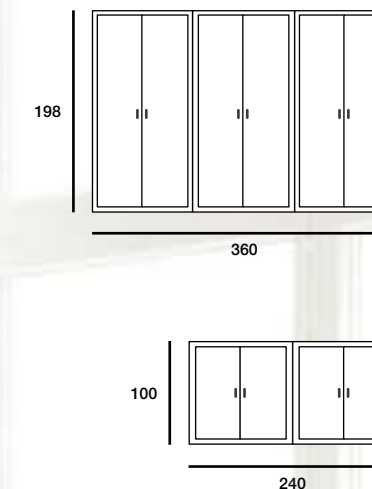

MODULE / MÓDULO / STORAGE

Tôle laminée / Chapa laminada / Cold-rolled sheet 0,8 mm

FINITION STRUCTURE / ACABADO ESTRUCTURA / FRAME FINISH

Peinture époxy
Pintura epoxi
Epoxy paint

HAUTEUR / ALTURA / HEIGHT

Fixe:
Fija: 50, 70, 100, 135, 160, 198 cm
Fixed:

Poignée métallique
(finition structure)
Tirador metálico
(acabado estructura)
Metal handle
(frame finish)

BASIC



Poignée PVC
(Fermeture magnétique)
Tirador PVC
(Cierre magnético)
PVC handle
(Magnetic closing)

PLUS



Tops d'union
individuels et multiples
Tapas individuales
y múltiples
Individual
and multiple tops



| PENDERIE

| ROPERO

| WARDROBE

La distribution des étagères est idéale pour tous les besoins.

La disposición interior de los estantes del armario ropero es ideal para cualquier necesidad.

Shelves are ready to arrange any kind of clothing need.



ARMOIRES
DÉMONTÉES
(RIDEAU)

ARMARIO
DESMONTADO
(PERSIANA)

DISASSEMBLED
TAMBOUR DOORS
CABINET



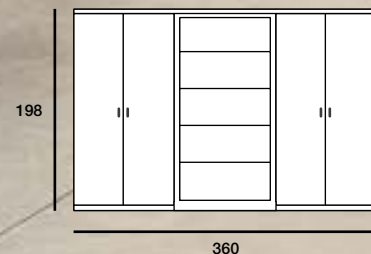

ARMOIRES
OUVERTES -
PORTES

ARMARIOS
HUECO -
PUERTAS

CABINET WITH
SHELVES AND
LOW DOORS



ARMOIRES DS
TÉLESCOPIQUES

ARCHIVOS
TELESCÓPICOS

TELESCOPIC
FILES

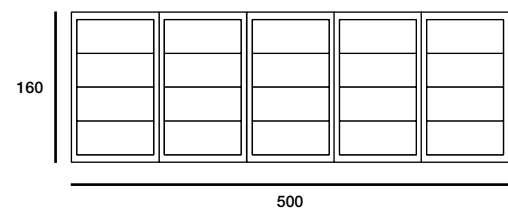
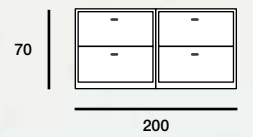

Réglage des tablettes intérieures chaque 25 mm.
Laterales con cremallera cada 25 mm.
Sides drilled every 25 mm.

ARMOIRE
OUVERTE
AVEC
ÉTAGÈRES

ARMARIOS
HUECO

SHELVES
CABINET

Armoires pour les dossiers
suspendus.
Ideal para colgar carpetas
For hanging folders.

CAISSON
PORTEURS
MÉTALLIQUES

CAJONERA
METÁLICA
SOPORTANTE

METAL
FIXED
PEDESTAL



Finitions métalliques: argent, blanc ou graphite.
Disponible en tres acabados: plata, blanco o grafito.
Available in three finishes: silver, white or graphite.

CAISSON HAUTEUR BUREAU
CAJONERA METÁLICA ADOSADA
FIXED PEDESTALS

Ouverture des tiroirs sans poignée.
Sistema de apertura muy práctico sin tirador.
Opening system is without handle.



CAISSON À ROULETTES
CAJONERA CON RUEDAS
MOBILE PEDESTAL

Une bonne solution pour avoir un meuble auxiliaire.
Ideal como mueble auxiliar.
It is a perfect solution as an auxiliar furniture.



CRÉDENCE MÉTALLIQUE
CREDENCIA METÁLICA
METAL CREDENZA

Espace pour UC + porte coulissante + tiroirs.
Con hueco para CPU + puerta corredera + cajones.
With CPU gap + sliding door + drawers.



ACCESSOIRES CAISSONS - PVC
ACCESORIOS PARA CUBETAS
PEDESTAL ACCESSORIES

MODÈLES | VARIANTES | VERSIONS

ARMOIRES BASIC / ARMARIOS BASIC / BASIC CABINETS

ÉTAGERES INCLUSES / ESTANTES INCLUIDOS / INCLUDED SHELVES

MODÈLE / VARIANTES / VERSIONS	TYPE / TIPO / TYPE	H.	RÉFÉRENCE / REFERENCIA / CODE		
			L. 120 cm	L. 100 cm	L. 80 cm
	Prof./ Depth. 43 cm	198 cm	195.302.---	195.312.---	195.322.---
		160 cm	195.303.---	195.313.---	195.323.---
		135 cm	195.305.---	195.315.---	195.325.---
		100 cm	195.307.---	195.317.---	195.327.---
		70 cm	195.309.---	195.319.---	195.329.---
		50 cm	195.010.---	195.020.---	195.030.---

Armoires à rideaux
Puertas persiana
Tambour doors cabinet

MODÈLE / VARIANTES / VERSIONS	TYPE / TIPO / TYPE	H.	RÉFÉRENCE / REFERENCIA / CODE		
			L. 120 cm	L. 100 cm	L. 80 cm
	Type / Tipo / Type A - B Prof./ Depth. 43 cm	198 cm	195.332.---		
		160 cm	195.333.---		

Penderie à rideaux
Ropero con puertas persiana
Wardrobe with tambour doors

FINITIONS | ACABADOS | FINISHES

STRUCTURE ARMOIRE MÉTALLIQUE
ESTRUCTURA LIBRERÍA EN METAL
METAL FRAME

PVC TYPE / TIPO / TYPE A Rideaux: couleurs unies / Con persiana en acabado liso / Tambour door finishes: plain colors.
TYPE / TIPO / TYPE B Rideaux: Couleurs métallisées et veinées / Con persiana en acabado metalizado o vetado / Tambour door finishes: metalized or veined colors.

BASIC	TYPE / TIPO / TYPE A				TYPE / TIPO / TYPE B			
	500 Gris Gris Grey	501 Blanc Blanco White	502 Argent Plata Silver	503 Hêtre Haya Beech	504 Chêne Moyen Roble Maple	505 Poirier Peral Pear	506 Wengué Wengue Wengue	754 Acacia Clair Acacia Clara Light Acacia
	347 Noir Negro Black		755 Acacia Foncé Acacia Oscura Dark Acacia	510 Graphite Grafito Graphite	478 Chêne Veiné Castaño Claro Oak	479 Chêne Gris Castaño Oscuro Dark Oak		
	511 Gris Gris Grey	512 Blanc Blanco White	513 Argent Plata Silver	514 Hêtre Haya Beech	515 Chêne Moyen Roble Maple	516 Poirier Peral Pear	517 Wengué Wengue Wengue	757 Acacia Clair Acacia Clara Light Acacia
	348 Noir Negro Black		758 Acacia Foncé Acacia Oscura Dark Acacia	521 Graphite Grafito Graphite	850 Chêne Veiné Castaño Claro Oak	851 Chêne Gris Castaño Oscuro Dark Oak		
	544 Gris Gris Grey	545 Blanc Blanco White	546 Argent Plata Silver	547 Hêtre Haya Beech	548 Chêne Moyen Roble Maple	549 Poirier Peral Pear	550 Wengué Wengue Wengue	760 Acacia Clair Acacia Clara Light Acacia
	349 Noir Negro Black		761 Acacia Foncé Acacia Oscura Dark Acacia	557 Graphite Grafito Graphite	856 Chêne Veiné Castaño Claro Oak	857 Chêne Gris Castaño Oscuro Dark Oak		
	558 Gris Gris Grey	559 Blanc Blanco White	560 Argent Plata Silver	565 Hêtre Haya Beech	566 Chêne Moyen Roble Maple	567 Poirier Peral Pear	568 Wengué Wengue Wengue	763 Acacia Clair Acacia Clara Light Acacia
	350 Noir Negro Black		764 Acacia Foncé Acacia Oscura Dark Acacia	572 Graphite Grafito Graphite	858 Chêne Veiné Castaño Claro Oak	859 Chêne Gris Castaño Oscuro Dark Oak		
	352 Gris Gris Grey	353 Blanc Blanco White	354 Argent Plata Silver	355 Hêtre Haya Beech	356 Chêne Moyen Roble Maple	357 Poirier Peral Pear	358 Wengué Wengue Wengue	363 Acacia Clair Acacia Clara Light Acacia
	351 Noir Negro Black		364 Acacia Foncé Acacia Oscura Dark Acacia	362 Graphite Grafito Graphite	382 Chêne Veiné Castaño Claro Oak	383 Chêne Gris Castaño Oscuro Dark Oak		

MODÈLES | VARIANTES | VERSIONS

ARMOIRES PLUS / ARMARIOS PLUS / PLUS CABINETS

ÉTAGERES INCLUSES / ESTANTES INCLUIDOS / INCLUDED SHELVES

MODÈLE / VARIANTES / VERSIONS	TYPE / TIPO / TYPE	H.	RÉFÉRENCE / REFERENCIA / CODE		
			L. 120 cm	L. 100 cm	L. 80 cm
	Prof./ Depth. 43 cm	198 cm	195.402.---	195.412.---	195.422.---
		160 cm	195.403.---	195.413.---	195.423.---
		135 cm	195.405.---	195.415.---	195.425.---
		100 cm	195.407.---	195.417.---	195.427.---
		70 cm	195.409.---	195.419.---	195.429.---
		50 cm	195.210.---	195.220.---	195.230.---

Armoires à rideaux
Puertas persiana
Tambour doors cabinet

MODÈLE / VARIANTES / VERSIONS	TYPE / TIPO / TYPE	H.	RÉFÉRENCE / REFERENCIA / CODE		
			L. 120 cm	L. 100 cm	L. 80 cm
	Type / Tipo / Type E - F Prof./ Depth. 43 cm	198 cm	195.432.---		
		160 cm	195.433.---		

Penderie à rideaux
Ropero con puertas persiana
Wardrobe with tambour doors

FINITIONS | ACABADOS | FINISHES

STRUCTURE ARMOIRE MÉTALLIQUE
ESTRUCTURA LIBRERÍA EN METAL
METAL FRAME







PVC TYPE / TIPO / TYPE E Rideaux: couleurs unies / Con persiana en acabado liso / Tambour door finishes: plain colors.
TYPE / TIPO / TYPE F Rideaux: Couleurs métallisées et veinées / Con persiana en acabado metalizado o vetado / Tambour door finishes: metalized or veined colors.

PLUS	TYPE / TIPO / TYPE E				TYPE / TIPO / TYPE F			
	500 Gris Gris Grey	501 Blanc Blanco White	502 Argent Plata Silver	503 Hêtre Haya Beech	504 Chêne Moyen Roble Maple	505 Poirier Peral Pear	506 Wengué Wengue Wengue	754 Acacia Clair Acacia Clara Light Acacia
	347 Noir Negro Black		755 Acacia Foncé Acacia Oscura Dark Acacia	510 Graphite Grafito Graphite	478 Chêne Veiné Castaño Claro Oak	479 Chêne Gris Castaño Oscuro Dark Oak		
	511 Gris Gris Grey	512 Blanc Blanco White	513 Argent Plata Silver	514 Hêtre Haya Beech	515 Chêne Moyen Roble Maple	516 Poirier Peral Pear	517 Wengué Wengue Wengue	757 Acacia Clair Acacia Clara Light Acacia
	348 Noir Negro Black		758 Acacia Foncé Acacia Oscura Dark Acacia	521 Graphite Grafito Graphite	850 Chêne Veiné Castaño Claro Oak	851 Chêne Gris Castaño Oscuro Dark Oak		
	544 Gris Gris Grey	545 Blanc Blanco White	546 Argent Plata Silver	547 Hêtre Haya Beech	548 Chêne Moyen Roble Maple	549 Poirier Peral Pear	550 Wengué Wengue Wengue	760 Acacia Clair Acacia Clara Light Acacia
	349 Noir Negro Black		761 Acacia Foncé Acacia Oscura Dark Acacia	557 Graphite Grafito Graphite	856 Chêne Veiné Castaño Claro Oak	857 Chêne Gris Castaño Oscuro Dark Oak		
	558 Gris Gris Grey	559 Blanc Blanco White	560 Argent Plata Silver	565 Hêtre Haya Beech	566 Chêne Moyen Roble Maple	567 Poirier Peral Pear	568 Wengué Wengue Wengue	763 Acacia Clair Acacia Clara Light Acacia
	350 Noir Negro Black		764 Acacia Foncé Acacia Oscura Dark Acacia	572 Graphite Grafito Graphite	858 Chêne Veiné Castaño Claro Oak	859 Chêne Gris Castaño Oscuro Dark Oak		
	352 Gris Gris Grey	353 Blanc Blanco White	354 Argent Plata Silver	355 Hêtre Haya Beech	356 Chêne Moyen Roble Maple	357 Poirier Peral Pear	358 Wengué Wengue Wengue	363 Acacia Clair Acacia Clara Light Acacia
	351 Noir Negro Black		364 Acacia Foncé Acacia Oscura Dark Acacia	362 Graphite Grafito Graphite	382 Chêne Veiné Castaño Claro Oak	383 Chêne Gris Castaño Oscuro Dark Oak		

MODÈLES | VARIANTES | VERSIONS

ARMOIRES / ARMARIOS / CABINETS

ÉTAGÈRES INCLUSES / ESTANTES INCLUIDOS / INCLUDED SHELVES

MODÈLE / VARIANTES / VERSIONS	TYPE / TIPO / TYPE	H.	RÉFÉRENCE / REFERENCIA / CODE		
	Prof./ Depth. 43 cm	198 cm	L. 120 cm 197.002.---	L. 100 cm 197.012.---	L. 80 cm 197.022.---
		160 cm	197.003.---	197.013.---	197.023.---
		135 cm	197.005.---	197.015.---	197.025.---
		100 cm	197.007.---	197.017.---	197.027.---
		70 cm	197.009.---	197.019.---	197.029.---
		50 cm	197.010.---	197.020.---	197.030.---
Armoire ouverte avec étagères Armario hueco Shelves cabinet			FINITIONS ACABADOS FINISHES 303 301 111 108 124 <small>RAL 7035 RAL 7015 RAL 9006 RAL 9016 RAL 9005</small>		
	Prof./ Depth. 43 cm	198 cm	L. 120 cm 197.202.---	L. 100 cm 197.212.---	L. 80 cm 197.222.---
		160 cm	197.203.---	197.213.---	197.223.---
		135 cm	197.205.---	197.215.---	197.225.---
		100 cm	197.207.---	197.217.---	197.227.---
		70 cm	197.209.---	197.219.---	197.229.---
		50 cm	197.210.---	197.220.---	197.230.---
Armoire portes battantes Armario con puertas batientes Hinged doors cabinet					
	Prof./ Depth. 43 cm	198 cm	197.290.---		
		160 cm	197.292.---		
Penderie portes battantes Ropero con puertas Wardrobe with doors					
	Prof./ Depth. 43 cm	135 cm	197.240.---	197.246.---	197.252.---
		100 cm	197.242.---	197.248.---	197.254.---
		70 cm	197.244.---	197.250.---	197.256.---
Armoire DS Archivo File cabinet					
	Prof./ Depth. 43 cm	198 cm	197.272.---	197.276.---	197.280.---
		160 cm	197.274.---	197.278.---	197.282.---
		135 cm	197.275.---	197.279.---	197.284.---
Armoire ouverte - portes Hueco - puertas Shelves with low doors					
	Prof./ Depth. 43 cm	198 cm	197.260.---	197.264.---	197.268.---
		160 cm	197.262.---	197.266.---	197.270.---
		135 cm	197.263.---	197.267.---	197.271.---
Armoire ouverte - DS Hueco - archivo Shelves with low files					

FINITIONS | ACABADOS | FINISHES

STRUCTURE ARMOIRE MÉTALLIQUE
ESTRUCTURA LIBRERÍA EN METAL
METAL FRAME

JEU DE PORTES ET FAÇADES
JUEGO DE PUERTAS Y DELANTERAS
HINGED DOORS AND FRONTS

 Gris Gris Grey
RAL 7035

- 388** Graphite Grafito Graphite
- 389** Argent Plata Silver
- 716** Noir Negro Black
- 390** Blanc Blanco White
- 391** Gris Gris Grey
- 392** Hêtre Haya Beech
- 393** Chêne Moyen Roble Maple
- 394** Poirier Peral Pear
- 395** Wengué Wengue Wengue
- 739** Acacia Clair Acacia Clara Light Acacia
- 740** Acacia Foncé Acacia Oscura Dark Acacia
- 287** Chêne Veiné Castaño Claro Oak
- 288** Chêne Grisé Castaño Oscuro Dark Oak

 Graphite Grafito Graphite
RAL 7015

- 686** Graphite Grafito Graphite
- 687** Argent Plata Silver
- 717** Noir Negro Black
- 688** Blanc Blanco White
- 689** Gris Gris Grey
- 690** Hêtre Haya Beech
- 691** Chêne Moyen Roble Maple
- 692** Poirier Peral Pear
- 693** Wengué Wengue Wengue
- 742** Acacia Clair Acacia Clara Light Acacia
- 743** Acacia Foncé Acacia Oscura Dark Acacia
- 878** Chêne Veiné Castaño Claro Oak
- 879** Chêne Grisé Castaño Oscuro Dark Oak

 Argent Plata Silver
RAL 9006

- 020** Graphite Grafito Graphite
- 040** Argent Plata Silver
- 718** Noir Negro Black
- 060** Blanc Blanco White
- 064** Gris Gris Grey
- 065** Hêtre Haya Beech
- 066** Chêne Moyen Roble Maple
- 067** Poirier Peral Pear
- 068** Wengué Wengue Wengue
- 706** Acacia Clair Acacia Clara Light Acacia
- 707** Acacia Foncé Acacia Oscura Dark Acacia
- 031** Chêne Veiné Castaño Claro Oak
- 032** Chêne Grisé Castaño Oscuro Dark Oak

 Blanc Blanco White
RAL 9016

- 138** Graphite Grafito Graphite
- 095** Argent Plata Silver
- 719** Noir Negro Black
- 096** Blanc Blanco White
- 097** Gris Gris Grey
- 098** Hêtre Haya Beech
- 099** Chêne Moyen Roble Maple
- 100** Poirier Peral Pear
- 101** Wengué Wengue Wengue
- 709** Acacia Clair Acacia Clara Light Acacia
- 710** Acacia Foncé Acacia Oscura Dark Acacia
- 166** Chêne Veiné Castaño Claro Oak
- 167** Chêne Grisé Castaño Oscuro Dark Oak



 Noir Negro Black
RAL 9005

- 165** Graphite Grafito Graphite
- 164** Argent Plata Silver
- 715** Noir Negro Black
- 102** Blanc Blanco White
- 153** Gris Gris Grey
- 154** Hêtre Haya Beech
- 155** Chêne Moyen Roble Maple
- 156** Poirier Peral Pear
- 158** Wengué Wengue Wengue
- 712** Acacia Clair Acacia Clara Light Acacia
- 713** Acacia Foncé Acacia Oscura Dark Acacia
- 189** Chêne Veiné Castaño Claro Oak
- 193** Chêne Grisé Castaño Oscuro Dark Oak



MODÈLES | VARIANTES | VERSIONS

CAISSONS / CAJONERAS / PEDESTALS

MODÈLE / VARIANTES / VERSIONS	TYPE / TIPO / TYPE	DIMENSIONS / MEDIDAS / MEASUREMENTS	RÉFÉRENCE / REFERENCIA / CODE	
 Caisson HB top rectangulaire Cajonera adosada Fixed pedestal with top	Prof./ Depth. 62 cm	44 x 73 cm	402.072.-.-	402.073.-.-
 Caisson HB top arc Cajonera adosada con sobre arco Fixed pedestal with bow top	Prof./ Depth. 62 cm	44 x 73 cm	402.074.-.-	402.075.-.-



FINITIONS | ACABADOS | FINISHES

CORPS / ESTRUCTURA / FRAME | TOP / SOBRES / TOP

 Argent Plata Silver RAL 9006	095 Argent Plata Silver	060 Blanc Blanco White	064 Gris Gris Grey	065 Hêtre Haya Beech	066 Chêne Moyen Roble Maple
	067 Poirier Peral Pear	068 Wengué Wengue Wengue	706 Acacia Clair Acacia Clara Light Acacia	707 Acacia Foncé Acacia Oscura Dark Acacia	020 Graphite Grafito Graphite
	031 Chêne Veiné Castaño Claro Oak	032 Chêne Gris Castaño Oscuro Dark Oak			
 Blanc Blanco White RAL 9016	126 Argent Plata Silver	096 Blanc Blanco White	097 Gris Gris Grey	098 Hêtre Haya Beech	099 Chêne Moyen Roble Maple
	100 Poirier Peral Pear	101 Wengué Wengue Wengue	709 Acacia Clair Acacia Clara Light Acacia	710 Acacia Foncé Acacia Oscura Dark Acacia	127 Graphite Grafito Graphite
	166 Chêne Veiné Castaño Claro Oak	167 Chêne Gris Castaño Oscuro Dark Oak			
 Graphite Grafito Graphite RAL 7022	160 Argent Plata Silver	163 Blanc Blanco White	180 Gris Gris Grey	181 Hêtre Haya Beech	182 Chêne Moyen Roble Maple
	183 Poirier Peral Pear	184 Wengué Wengue Wengue	715 Acacia Clair Acacia Clara Light Acacia	716 Acacia Foncé Acacia Oscura Dark Acacia	113 Graphite Grafito Graphite
	206 Chêne Veiné Castaño Claro Oak	208 Chêne Gris Castaño Oscuro Dark Oak			

MODÈLES | VARIANTES | VERSIONS

CAISSONS / CAJONERAS / PEDESTALS

MODÈLE / VARIANTES / VERSIONS	TYPE / TIPO / TYPE	DIMENSIONS / MEDIDAS / MEASUREMENTS	RÉFÉRENCE / REFERENCIA / CODE	
 Caisson porteur Cajonera soportante Fixex pedestal (under desk top)	Prof./ Depth. 55 cm	42 x 70,5 cm	402.032.-.-	402.033.-.-
 Caisson à roulettes Cajonera con ruedas Mobile pedestal	Prof./ Depth. 55 cm	42 x 55 cm	402.036.-.-	402.037.-.-

FINITIONS | ACABADOS | FINISHES

111 Argent Plata Silver RAL 9006	108 Blanc Blanco White RAL 9016	107 Graphite Grafito Graphite RAL 7022
--------------------------------------------	-------------------------------------------	--------------------------------------------------



MODÈLES | VARIANTES | VERSIONS

CRÉDENCE / CREDENCIA / CREDENZA

MODÈLE / VARIANTES / VERSIONS	TYPE / TIPO / TYPE	DIMENSIONS / MEDIDAS / MEASUREMENTS	RÉFÉRENCE / REFERENCIA / CODE	
 Crédence avec structure métallique Credencia con estructura metálica Metal structure credenza	Haut de gamme / Gama alta / Top range Gamme basique / Gama básica / Basic range Gamme mélamine / Gama madera / Melamine drawer	Gauche / Izquierda / Left	3 Tiroirs / Cajones / Drawers	1 Tiroir / Cajón / Drawer + 1 DS / Archivo / File
		125,6 x 54,2 x 57,5 cm	362.415.-.-	362.417.-.-
		125,6 x 54,2 x 57,5 cm	362.435.-.-	362.437.-.-
	Haut de gamme / Gama alta / Top range Gamme basique / Gama básica / Basic range Gamme mélamine / Gama madera / Melamine drawer	Droite / Derecha / Right	362.414.-.-	362.416.-.-
		125,6 x 54,2 x 57,5 cm	362.434.-.-	362.436.-.-
		125,6 x 54,2 x 57,5 cm	362.454.-.-	362.456.-.-

FINITIONS | ACABADOS | FINISHES

CORPS / ESTRUCTURA / FRAME | FAÇADES ET TOP / DELANTERAS Y SOBRE / FRONT AND TOP

 Blanc Blanco White RAL 9016	096 Blanc Blanco White	097 Gris Gris Grey	098 Hêtre Haya Beech	099 Chêne Moyen Roble Maple	100 Poirier Peral Pear
	101 Wengué Wengue Wengue	709 Acacia Clair Acacia Clara Light Acacia	710 Acacia Foncé Acacia Oscura Dark Acacia	206 Chêne Veiné Castaño Claro Oak	208 Chêne Gris Castaño Oscuro Dark Oak
 Argent Plata Silver RAL 9006	060 Blanc Blanco White	064 Gris Gris Grey	065 Hêtre Haya Beech	066 Chêne Moyen Roble Maple	067 Poirier Peral Pear
	068 Wengué Wengue Wengue	706 Acacia Clair Acacia Clara Light Acacia	707 Acacia Foncé Acacia Oscura Dark Acacia	206 Chêne Veiné Castaño Claro Oak	208 Chêne Gris Castaño Oscuro Dark Oak

LOK

Lok est une série de casiers pour bureaux, hôtels, salles d'exposition, centres éducatifs, etc. Au bureau, il se présente comme une solution qui complète les besoins des postes de travail nomades et contemporains, offrant un rangement personnel pour des lieux flexibles.

LOK es una serie de taquillas para las oficinas, los hoteles, las salas de exposiciones, los centros educativos, etc. En la oficina se presenta como una solución que complementa las necesidades de los puestos de trabajo nómadas y contemporáneos, ofreciendo almacenaje personal para lugares flexibles.

LOK lockers for offices, hotels, exhibitionhalls, schools, etc. Good, secure lockers are indispensable in a modern office, which means that new ways of working do not necessarily require a permanent personal workplace.

MODULE / MÓDULO / STORAGE

Mélamine / Melamina / Melamine: 25 mm
Chant en ABS / Canto ABS / ABS edges

FINITION STRUCTURE / ACABADO ESTRUCTURA / FRAME FINISH

Mélamine
Melamina
Melamine

HAUTEUR / ALTURA / HEIGHT

Fixe:
Fija:
Fixed: 90'6, 133, 175 cm

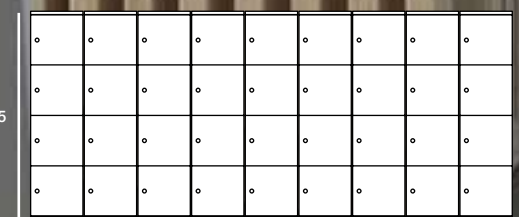



CASIERS
AVEC FENTE

TAQUILLA
CON BUZÓN

LOCKERS WITH
MAIL-HOLE
DOORS

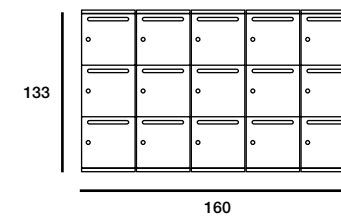



Cintre extensible: Pour vêtements.
Perchero extensible: para ropa.
Telescopic hanger: for clothes.

ARMOIRE
PENDERIE

PERCHERO

HANGING
CABINET

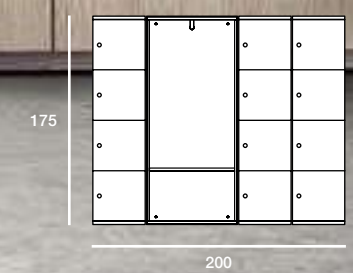

CASIERS AVEC
SERRURE À
COMBINAISON

TAQUILLAS CON
COMBINACIÓN

LOCKERS WITH
4-DIGIT LOCK

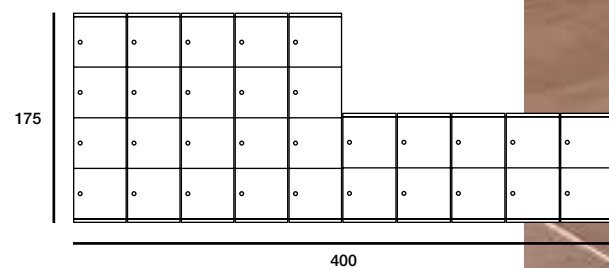

MODÈLES | VARIANTES | VERSIONS

CASIEROS MULTICOLORES / TAQUILLA MULTICOLOR / MULTICOLOR LOCKERS

MODÈLE / VARIANTES / VERSIONS	DIMENSIONS / MEDIDAS / MEASUREMENTS	RÉFÉRENCE / REFERENCIA / CODE									
	175 cm 133 cm 90,6 cm	<table border="0"> <tr> <td>695.010.051</td> <td>695.010.053</td> <td>695.010.007</td> </tr> <tr> <td>695.012.051</td> <td>695.012.053</td> <td>695.012.007</td> </tr> <tr> <td>695.014.051</td> <td>695.014.053</td> <td>695.014.007</td> </tr> </table>	695.010.051	695.010.053	695.010.007	695.012.051	695.012.053	695.012.007	695.014.051	695.014.053	695.014.007
695.010.051	695.010.053	695.010.007									
695.012.051	695.012.053	695.012.007									
695.014.051	695.014.053	695.014.007									
Structure - Avec fente Estructura - Con buzón Structure - Mail-hole doors											

	175 cm 133 cm 90,6 cm	<table border="0"> <tr> <td>695.030.051</td> <td>695.030.053</td> <td>695.030.007</td> </tr> <tr> <td>695.032.051</td> <td>695.032.053</td> <td>695.032.007</td> </tr> <tr> <td>695.034.051</td> <td>695.034.053</td> <td>695.034.007</td> </tr> </table>	695.030.051	695.030.053	695.030.007	695.032.051	695.032.053	695.032.007	695.034.051	695.034.053	695.034.007
695.030.051	695.030.053	695.030.007									
695.032.051	695.032.053	695.032.007									
695.034.051	695.034.053	695.034.007									
Structure - Avec fente - sans top Estructura - Con buzón - sin tapa Structure - Mail-hole doors without top											

MODÈLE / VARIANTES / VERSIONS	SERRURES / CERRADURA / LOCK TYPES	TYPE / TIPO / TYPE	RÉFÉRENCE / REFERENCIA / CODE
	CLÉ / LLAVE / KEY	P1 P2 P3 P4	1.695.101... 1.695.102... 1.695.103... 1.695.104...
	COMBINAISON / COMBINACIÓN / 4-DIGIT LOCK	P1 P2 P3 P4	1.695.201... 1.695.202... 1.695.203... 1.695.204...
	CARTE RFID / TARJETA RFID / RFID CARD	P1 P2 P3 P4	1.695.301... 1.695.302... 1.695.303... 1.695.304...
	ELECTRONIQUE / ELECTRÓNICA / ELECTRONIC	P1 P2 P3 P4	1.695.401... 1.695.402... 1.695.403... 1.695.404...
Porte avec fente boîte aux lettres Puertas con buzón Mail-hole doors			

FINITIONS | ACABADOS | FINISHES

STRUCTURE / ESTRUCTURA / FRAME | PORTE / PUERTA / DOORS

MODÈLES | VARIANTES | VERSIONS

CASIEROS MULTICOLORES / TAQUILLA MULTICOLOR / MULTICOLOR LOCKERS

MODÈLE / VARIANTES / VERSIONS	DIMENSIONS / MEDIDAS / MEASUREMENTS	RÉFÉRENCE / REFERENCIA / CODE									
	175 cm 133 cm 90,6 cm	<table border="0"> <tr> <td>695.020.051</td> <td>695.020.053</td> <td>695.020.007</td> </tr> <tr> <td>695.022.051</td> <td>695.022.053</td> <td>695.022.007</td> </tr> <tr> <td>695.024.051</td> <td>695.024.053</td> <td>695.024.007</td> </tr> </table>	695.020.051	695.020.053	695.020.007	695.022.051	695.022.053	695.022.007	695.024.051	695.024.053	695.024.007
695.020.051	695.020.053	695.020.007									
695.022.051	695.022.053	695.022.007									
695.024.051	695.024.053	695.024.007									
Structure - Sans fente Estructura - Sin buzón Structure - Doors											

	175 cm 133 cm 90,6 cm	<table border="0"> <tr> <td>695.040.051</td> <td>695.040.053</td> <td>695.040.007</td> </tr> <tr> <td>695.042.051</td> <td>695.042.053</td> <td>695.042.007</td> </tr> <tr> <td>695.044.051</td> <td>695.044.053</td> <td>695.044.007</td> </tr> </table>	695.040.051	695.040.053	695.040.007	695.042.051	695.042.053	695.042.007	695.044.051	695.044.053	695.044.007
695.040.051	695.040.053	695.040.007									
695.042.051	695.042.053	695.042.007									
695.044.051	695.044.053	695.044.007									
Structure - Sans fente - sans top Estructura - Sin buzón - sin tapa Structure - Doors without top											

MODÈLE / VARIANTES / VERSIONS	SERRURES / CERRADURA / LOCK TYPES	TYPE / TIPO / TYPE	RÉFÉRENCE / REFERENCIA / CODE
	CLÉ / LLAVE / KEY	P1 P2 P3 P4	1.695.121... 1.695.122... 1.695.123... 1.695.124...
	COMBINAISON / COMBINACIÓN / 4-DIGIT LOCK	P1 P2 P3 P4	1.695.221... 1.695.222... 1.695.223... 1.695.224...
	CARTE RFID / TARJETA RFID / RFID CARD	P1 P2 P3 P4	1.695.321... 1.695.322... 1.695.323... 1.695.324...
	ELECTRONIQUE / ELECTRÓNICA / ELECTRONIC	P1 P2 P3 P4	1.695.421... 1.695.422... 1.695.423... 1.695.424...
Porte sans fente Puertas sin buzón Doors			

FINITIONS | ACABADOS | FINISHES

STRUCTURE / ESTRUCTURA / FRAME | PORTE / PUERTA / DOORS

MODÈLES | VARIANTES | VERSIONS

CASIERI MONOCHROMES / TAQUILLA MONOCOLOR / SINGLE-COLOR LOCKERS

MODÈLE / VARIANTES / VERSIONS	SERRURES / CERRADURA / LOCK TYPES	DIMENSIONS / MEDIDAS / MEASUREMENTS	RÉFÉRENCE / REFERENCIA / CODE
	CLÉ / LLAVE / KEY	175 cm 133 cm 90,6 cm	695.101.-.- 695.102.-.- 695.103.-.-
	COMBINAISON / COMBINACIÓN / 4-DIGIT LOCK	175 cm 133 cm 90,6 cm	695.201.-.- 695.202.-.- 695.203.-.-
	CARTE RFID / TARJETA RFID / RFID CARD	175 cm 133 cm 90,6 cm	695.301.-.- 695.302.-.- 695.303.-.-
Avec fente Con buzón Mail-hole doors	ELECTRONIQUE / ELECTRÓNICA / ELECTRONIC	175 cm 133 cm 90,6 cm	695.401.-.- 695.402.-.- 695.403.-.-

	CLÉ / LLAVE / KEY	175 cm 133 cm 90,6 cm	695.111.-.- 695.112.-.- 695.113.-.-
	COMBINAISON / COMBINACIÓN / 4-DIGIT LOCK	175 cm 133 cm 90,6 cm	695.211.-.- 695.212.-.- 695.213.-.-
	CARTE RFID / TARJETA RFID / RFID CARD	175 cm 133 cm 90,6 cm	695.311.-.- 695.312.-.- 695.313.-.-
Avec fente - sans top Con buzón - sin tapa Mail-hole doors without top	ELECTRONIQUE / ELECTRÓNICA / ELECTRONIC	175 cm 133 cm 90,6 cm	695.411.-.- 695.412.-.- 695.413.-.-

FINITIONS | ACABADOS | FINISHES

051	Argent Plata Silver	053	Blanc Blanco White	054	Gris Gris Grey	055	Hêtre Haya Beech	061	Chêne Moyen Roble Maple
062	Poirier Peral Pear	116	Wengué Wengue Wengue	103	Acacia Clair Acacia Clara Light Acacia	104	Acacia Foncé Acacia Oscura Dark Acacia	007	Graphite Grafito Graphite
272	Chêne Veiné Castaño Claro Oak	273	Chêne Grisé Castaño Oscuro Dark Oak						

MODÈLES | VARIANTES | VERSIONS

CASIERI MONOCHROMES / TAQUILLA MONOCOLOR / SINGLE-COLOR LOCKERS





MODÈLE / VARIANTES / VERSIONS	SERRURES / CERRADURA / LOCK TYPES	DIMENSIONS / MEDIDAS / MEASUREMENTS	RÉFÉRENCE / REFERENCIA / CODE
	CLÉ / LLAVE / KEY	175 cm 133 cm 90,6 cm	695.121.-.- 695.122.-.- 695.123.-.-
	COMBINAISON / COMBINACIÓN / 4-DIGIT LOCK	175 cm 133 cm 90,6 cm	695.221.-.- 695.222.-.- 695.223.-.-
	CARTE RFID / TARJETA RFID / RFID CARD	175 cm 133 cm 90,6 cm	695.321.-.- 695.322.-.- 695.323.-.-
Sans fente Sin buzón Doors	ELECTRONIQUE / ELECTRÓNICA / ELECTRONIC	175 cm 133 cm 90,6 cm	695.421.-.- 695.422.-.- 695.423.-.-

	CLÉ / LLAVE / KEY	175 cm 133 cm 90,6 cm	695.131.-.- 695.132.-.- 695.133.-.-
	COMBINAISON / COMBINACIÓN / 4-DIGIT LOCK	175 cm 133 cm 90,6 cm	695.231.-.- 695.232.-.- 695.233.-.-
	CARTE RFID / TARJETA RFID / RFID CARD	175 cm 133 cm 90,6 cm	695.331.-.- 695.332.-.- 695.333.-.-
Sans fente - sans top Sin buzón - sin tapa Doors without top	ELECTRONIQUE / ELECTRÓNICA / ELECTRONIC	175 cm 133 cm 90,6 cm	695.431.-.- 695.432.-.- 695.433.-.-

FINITIONS | ACABADOS | FINISHES

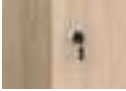
051	Argent Plata Silver	053	Blanc Blanco White	054	Gris Gris Grey	055	Hêtre Haya Beech	061	Chêne Moyen Roble Maple
062	Poirier Peral Pear	116	Wengué Wengue Wengue	103	Acacia Clair Acacia Clara Light Acacia	104	Acacia Foncé Acacia Oscura Dark Acacia	007	Graphite Grafito Graphite
272	Chêne Veiné Castaño Claro Oak	273	Chêne Grisé Castaño Oscuro Dark Oak						

CLÉS PASSE-PARTOUT | LLAVES MAESTRAS | MANDATORY MASTER KEY

MODÈLE / VARIANTES / VERSIONS	RÉFÉRENCE / REFERENCIA / CODE
 <p>Clé Llave Key</p>	1.695.766.000
 <p>Combinaison Combinación 4-digit lock</p>	1.695.764.000
 <p>Carte RFID Tarjeta RFID RFID card</p>	1.695.760.000
 <p>Electronique Electrónica Electronic</p>	1.695.762.000

MODÈLES | VARIANTES | VERSIONS

MONOCHROMES / MONOCOLOR / SINGLE-COLOR

MODÈLE / VARIANTES / VERSIONS	DIMENSIONS / MEDIDAS / MEASUREMENTS	RÉFÉRENCE / REFERENCIA / CODE
 <p>Armoire penderie Perchero Hanging cabinet</p>	175 cm	695.052.-.-

FINITIONS | ACABADOS | FINISHES

051 Argent Plata Silver	053 Blanc Blanco White	054 Gris Gris Grey	055 Hêtre Haya Beech	061 Chêne Moyen Roble Maple
062 Poirier Peral Pear	116 Wengué Wengue Wengue	103 Acacia Clair Acacia Clara Light Acacia	104 Acacia Foncé Acacia Oscura Dark Acacia	007 Graphite Grafito Graphite
272 Chêne Veiné Castaño Claro Oak	273 Chêne Grisé Castaño Oscuro Dark Oak			

COMPLÉMENTS | COMPLEMENTOS | COMPLEMENTS

MODÈLE / VARIANTES / VERSIONS	TYPE / TIPO / TYPE	RÉFÉRENCE / REFERENCIA / CODE
 <p>Tops d'union Tapas de unión Multi-tops</p>	2 Casiers / 2 Taquillas / 2 Lockers 3 Casiers / 3 Taquillas / 3 Lockers 4 Casiers / 4 Taquillas / 4 Lockers 5 Casiers / 5 Taquillas / 5 Lockers 6 Casiers / 6 Taquillas / 6 Lockers	1.695.010.-.- 1.695.008.-.- 1.695.006.-.- 1.695.004.-.- 1.695.002.-.-

FINITIONS | ACABADOS | FINISHES

051 Argent Plata Silver	053 Blanc Blanco White	054 Gris Gris Grey	055 Hêtre Haya Beech	061 Chêne Moyen Roble Maple
062 Poirier Peral Pear	116 Wengué Wengue Wengue	103 Acacia Clair Acacia Clara Light Acacia	104 Acacia Foncé Acacia Oscura Dark Acacia	007 Graphite Grafito Graphite
272 Chêne Veiné Castaño Claro Oak	273 Chêne Grisé Castaño Oscuro Dark Oak			

ORGATOWER

Ces tours d'organisation élargissent la vision des blocs-tiroirs individuels et proposent de nouvelles configurations pour créer des limites visuelles entre les postes de travail.

Las torres de organización extienden la visión de las cajoneras individuales y proponen nuevas configuraciones con las que crear límites visuales entre puestos de trabajo.

The orgatower creates visual boundaries between workstations and therefore certain privacy being in the same office space. At the same time it provides a voluminous and close-at-hand storage space for files, documents, and other items.



MODULE / MÓDULO / STORAGE

Mélamine / Melamina / Melamine: 25 mm

FINITION STRUCTURE / ACABADO ESTRUCTURA / FRAME FINISH

Mélamine
Melamina
Melamine

HAUTEUR / ALTURA / HEIGHT

Fixe:
Fija: 130, 73 cm
Fixed:



CHÂSSIS
TÉLESCOPIQUE

ARCHIVO
TELESCÓPICO

TELESCOPIC
FILES

| HAUTEUR 130 CM INDIVIDUEL
| ALTURA 130 CM INDIVIDUAL
| HEIGHT 130 CM SINGLE FACE

Glissières à roulements à billes et 1 tirette plumier incluse.
Con guías metálicas y 1 cajón plumier incluido.
Sliding guides and 1 pencil drawer included.



| HAUTEUR 130 CM INDIVIDUEL
| ALTURA 130 CM INDIVIDUAL
| HEIGHT 130 CM SINGLE FACE

Glissières à roulements à billes, 1 tirette plumier et 1 châssis télescopique inclus.
Con guías metálicas, 1 cajón plumier y 1 archivo telescópico.
Sliding guides, 1 pencil drawer and 1 telescopic file included.



| HAUTEUR 130 CM DOUBLE
| ALTURA 130 CM DOBLE
| HEIGHT 130 CM DOUBLE

Glissières à roulements à billes et 2 tirettes plumier incluses.
Con guías metálicas y 2 cajones plumier incluidos.
Sliding guides and 2 pencil drawers included.



| HAUTEUR 130 CM DOUBLE
| ALTURA 130 CM DOBLE
| HEIGHT 130 CM DOUBLE

Glissières à roulements à billes, 2 tirettes plumier et 1 châssis télescopique inclus.
Con guías metálicas, 2 cajones plumier y 1 archivo telescópico.
Sliding guides, 2 pencil drawers and 1 telescopic file included.





| HAUTEUR BUREAU - INDIVIDUEL
| ALTURA MESA INDIVIDUAL
| DESK HIGH - SINGLE FACE

Glissières à roulements à billes et 1 tirette plumier incluse.
Con guías metálicas y 1 cajón plumier incluido.
Sliding guides and 1 pencil drawer included.







| HAUTEUR BUREAU - INDIVIDUEL
| ALTURA MESA INDIVIDUAL
| DESK HIGH - SINGLE FACE

Glissières à roulements à billes, 1 tirette plumier et 1 châssis télescopique inclus.
Con guías metálicas, 1 cajón plumier y 1 archivo telescópico.
Sliding guides, 1 pencil drawer and 1 telescopic file included.

MODÈLES | VARIANTES | VERSIONS

ORGATOWER H.130 / ORGATOWER H.130 / ORGATOWER H.130

MODÈLE / VARIANTES / VERSIONS	TYPE / TIPO / TYPE	DIMENSIONS / MEDIDAS / MEASUREMENTS	RÉFÉRENCE / REFERENCIA / CODE
	Droite / Derecha / Right	80,3 x 45,3 x 130 cm	361.001... - -
Hauteur 130 cm individuel Altura 130 cm individual Height 130 cm single face	Gauche / Izquierda / Left		361.002... - -
Glissières à roulements à billes et 1 tirette plumier incluse / Con guías metálicas y 1 cajón plumier incluido / Sliding guides and 1 pencil drawer included			
		80,3 x 45,3 x 130 cm	361.003... - -
Hauteur 130 cm individuel Altura 130 cm individual Height 130 cm single face			
Glissières à roulements à billes, 1 tirette plumier et 1 châssis télescopique inclus / Con guías metálicas, 1 cajón plumier incluido y 1 archivo telescópico / Sliding guides, 1 pencil drawer and 1 telescopic file included			
	Droite / Derecha / Right	80,3 x 45,3 x 130 cm	361.011... - -
Hauteur 130 cm double Altura 130 cm doble Height 130 cm double	Gauche / Izquierda / Left		361.012... - -
Glissières à roulements à billes et 2 tirettes plumier incluses / Con guías metálicas y 2 cajones plumier incluidos / Sliding guides and 2 pencil drawers included			
		80,3 x 45,3 x 130 cm	361.013... - -
Hauteur 130 cm double Altura 130 cm doble Height 130 cm double			
Glissières à roulements à billes, 2 tirettes plumier et 1 châssis télescopique inclus / Con guías metálicas, 2 cajones plumier incluidos y 1 archivo telescópico / Sliding guides, 2 pencil drawers and 1 telescopic file included			

MODÈLES | VARIANTES | VERSIONS

ORGATOWER - HAUTEUR BUREAU / ORGATOWER - ALTURA MESA / ORGATOWER - DESK HIGH

MODÈLE / VARIANTES / VERSIONS	TYPE / TIPO / TYPE	DIMENSIONS / MEDIDAS / MEASUREMENTS	RÉFÉRENCE / REFERENCIA / CODE
	Droite / Derecha / Right	80,3 x 45,3 x 73 cm	361.004... - -
Hauteur bureau - Caisson Altura mesa individual Desk high - Single desk	Gauche / Izquierda / Left		361.005... - -
Glissières à roulements à billes et 1 tirette plumier incluse / Con guías metálicas y 1 cajón plumier incluido / Sliding guides and 1 pencil drawer included			
	Droite / Derecha / Right	80,3 x 45,3 x 73 cm	361.014... - -
Hauteur bureau - Caisson Altura mesa individual Desk high - Single desk	Gauche / Izquierda / Left		361.015... - -
Glissières à roulements à billes, 1 tirette plumier et 1 châssis télescopique inclus / Con guías metálicas, 1 cajón plumier incluido y 1 archivo telescópico / Sliding guides, 1 pencil drawer and 1 telescopic file included			

FINITIONS | ACABADOS | FINISHES

DESSOUS, JOUES ET FOND
BAJO, LATERALES Y TRASERA
BOTTOM, SIDE AND BACK PANELS

TOP ET FAÇADES
SOBRE Y DELANTERA
TOP AND FRONT

Argent Plata Silver	051	Argent Plata Silver	053	Blanc Blanco White	054	Gris Gris Grey	055	Hêtre Haya Beech	061	Chêne Moyen Roble Maple
	062	Poirier Peral Pear	116	Wengué Wengue Wengue	694	Acacia Clair Acacia Clara Light Acacia	695	Acacia Foncé Acacia Oscura Dark Acacia	125	Graphite Grafito Graphite
	272	Chêne Veiné Castaño Claro Oak	273	Chêne Grisé Castaño Oscuro Dark Oak						
Blanc Blanco White	088	Argent Plata Silver	081	Blanc Blanco White	076	Gris Gris Grey	077	Hêtre Haya Beech	078	Chêne Moyen Roble Maple
	079	Poirier Peral Pear	080	Wengué Wengue Wengue	168	Acacia Clair Acacia Clara Light Acacia	169	Acacia Foncé Acacia Oscura Dark Acacia	115	Graphite Grafito Graphite
	043	Chêne Veiné Castaño Claro Oak	106	Chêne Grisé Castaño Oscuro Dark Oak						
Graphite Grafito Graphite	228	Argent Plata Silver	229	Blanc Blanco White	230	Gris Gris Grey	231	Hêtre Haya Beech	232	Chêne Moyen Roble Maple
	234	Poirier Peral Pear	700	Acacia Clair Acacia Clara Light Acacia	701	Acacia Foncé Acacia Oscura Dark Acacia	204	Graphite Grafito Graphite	251	Chêne Veiné Castaño Claro Oak
	252	Chêne Grisé Castaño Oscuro Dark Oak								
Monochrome Monocolor Single-colour	197	Gris Gris Grey	198	Hêtre Haya Beech	199	Chêne Moyen Roble Maple	200	Poirier Peral Pear	202	Wengué Wengue Wengue
	103	Acacia Clair Acacia Clara Light Acacia	104	Acacia Foncé Acacia Oscura Dark Acacia	209	Chêne Veiné Castaño Claro Oak	235	Chêne Grisé Castaño Oscuro Dark Oak		

TISSUS TAPIZADOS UPHOLSTERY

Les procédés d'impression ne permettent pas une reproduction exacte des tonalités originales. Pour plus de fiabilité, veuillez consulter le nuancier tissu.

Los procedimientos de impresión no permiten una reproducción exacta de las tonalidades originales. Para una máxima fiabilidad consultar el catálogo de telas.

Printing procedures do not provide an exact reproduction of original colour tones. Please check the fabric sample book.

Série 1 / Serie 1 / Serie 1

ONE



Série 1 / Serie 1 / Serie 1

PUMA



Série 1 / Serie 1 / Serie 1

ARAN



Série 1 / Serie 1 / Serie 1



Série 1 / Serie 1 / Serie 1



Série 1 / Serie 1 / Serie 1



Série 1 / Serie 1 / Serie 1



Série 1 / Serie 1 / Serie 1

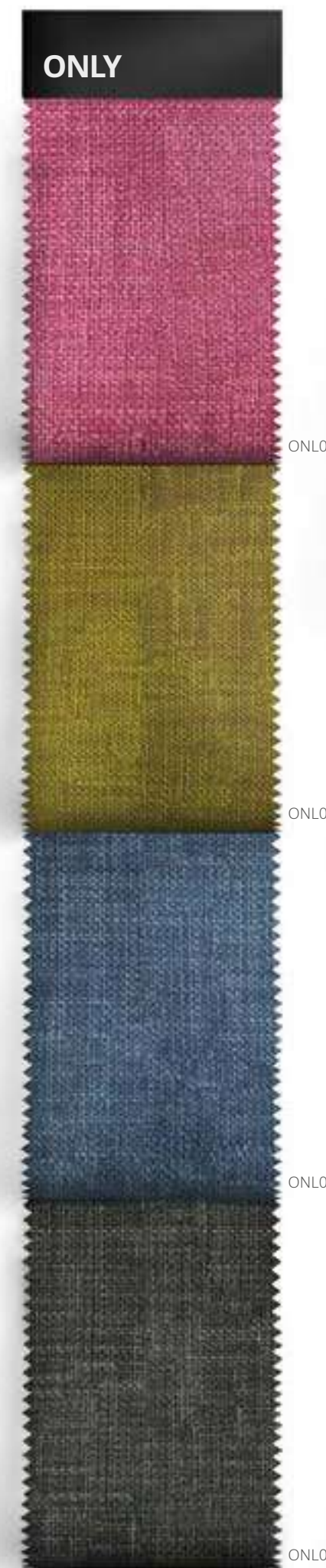

Série 4 / Serie 4 / Serie 4



Série 4 / Serie 4 / Serie 4



Série 4 / Serie 4 / Serie 4



Série 4 / Serie 4 / Serie 4



Série 4 / Serie 4 / Serie 4



Série 4 / Serie 4 / Serie 4



Série 7 / Serie 7 / Serie 7



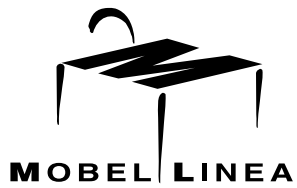

Mobel Linea, S.L. se réserve le droit de modifier les caractéristiques techniques des produits sans préavis en les adaptant au progrès technique. Les procédés d'impression ne permettent pas une reproduction exacte des tonalités originales. Pour plus de fiabilité, veuillez consulter le nuancier finitions. Textes, photos et illustrations non contractuels. / Mobel Linea, S.L. se reserva el derecho a introducir en estos productos sin previo aviso, las mejoras técnicas derivadas de su constante investigación. Los procedimientos de impresión no permiten una reproducción exacta de las tonalidades originales. Para una máxima fiabilidad consultar los catálogos de acabados. / Mobel Linea, S.L. reserves all rights to make technical changes and improvements at any time resulting from his ongoing research, without previous notice. Please bear in mind the actual finish may be slightly different. Since the printing does not show 100% the real colors. To make sure please look at